



# 92x92x25 mm

San Ace 92L 9LG type

## General Specifications

- Material ..... Frame: Aluminum, Impeller: Plastic (Flammability: UL 94V-1)
- Expected life ..... See the table below. (L10 life: 90% survival rate for continuous operation in free air at 60°C, rated voltage)
- Motor protection function ..... Locked rotor burnout protection, Reverse polarity protection  
For details, please refer to p. 547.
- Dielectric strength ..... 50/60 Hz, 500 VAC, for 1 minute (between lead wire conductors and frame)
- Insulation resistance ..... 10 MΩ or more with a 500 VDC megger (between lead wire conductors and frame)
- Sound pressure level (SPL) ..... At 1 m away from the air inlet
- Storage temperature ..... -30 to +70°C (Non-condensing)
- Lead wire ..... ⊕Red ⊖Black (Sensor) Yellow (Control) Brown  
(For models without PWM control function, there is no speed control wiring.)
- Mass ..... 150 g

## Specifications

The models listed below **have pulse sensors with PWM control function.**

Model no.	Rated voltage [V]	Operating voltage range [V]	PWM duty cycle* [%]	Rated current [A]	Rated input [W]	Rated speed [min <sup>-1</sup> ]	Max. airflow [m <sup>3</sup> /min] [CFM]	Max. static pressure [Pa] [inchH <sub>2</sub> O]	SPL [dB (A)]	Operating temperature [°C]	Expected life [h]
9LG0912P4J001	12	10.8 to 13.2	100	0.42	5.04	5000	2.2 77.7	105 0.42	44	-20 to +70	180000/60°C
9LG0912P4G001			100	0.3	3.6	4400	1.93 68.2	81 0.33	40		
9LG0912P4S001			100	0.22	2.64	3850	1.69 59.7	62.1 0.25	37		
9LG0912P4H001			100	0.15	1.8	3150	1.38 48.7	41.6 0.17	32		
9LG0924P4J001	24	21.6 to 26.4	100	0.21	5.04	5000	2.2 77.7	105 0.42	44		
9LG0924P4G001			100	0.15	3.6	4400	1.93 68.2	81 0.33	40		
9LG0924P4S001			100	0.11	2.64	3850	1.69 59.7	62.1 0.25	37		
9LG0924P4H001			100	0.07	1.68	3150	1.38 48.7	41.6 0.17	32		

\* PWM frequency: 25 kHz. Fan does not rotate when PWM duty cycle is 0%.

The following sensor and control options are available for selection.

Differs according to the model. Refer to the table on p. 576. Without sensor Pulse sensor Lock sensor

The models listed below **have pulse sensors.**

Model no.	Rated voltage [V]	Operating voltage range [V]	Rated current [A]	Rated input [W]	Rated speed [min <sup>-1</sup> ]	Max. airflow [m <sup>3</sup> /min] [CFM]	Max. static pressure [Pa] [inchH <sub>2</sub> O]	SPL [dB (A)]	Operating temperature [°C]	Expected life [h]
9LG0912F4001	12	10.2 to 13.8	0.1	1.2	2800	1.22 43.1	32.8 0.13	29	-20 to +70	180000/60°C
9LG0912M4001			0.08	0.96	2400	1.05 37.1	24.1 0.097	24		
9LG0912L4001			0.07	0.84	2000	0.87 30.7	16.7 0.067	19		
9LG0924F4001	24	20.4 to 27.6	0.05	1.2	2800	1.22 43.1	32.8 0.13	29		
9LG0924M4001			0.04	0.96	2400	1.05 37.1	24.1 0.097	24		
9LG0924L4001			0.03	0.72	2000	0.87 30.7	16.7 0.067	19		

The following sensor and control options are available for selection.

Available for all models. Without sensor Lock sensor

## Airflow - Static Pressure Characteristics / PWM Duty - Speed Characteristics Example

**9LG0912P4J001** With pulse sensor with PWM control function

PWM duty cycle

Operating voltage range

PWM duty - Speed characteristics example

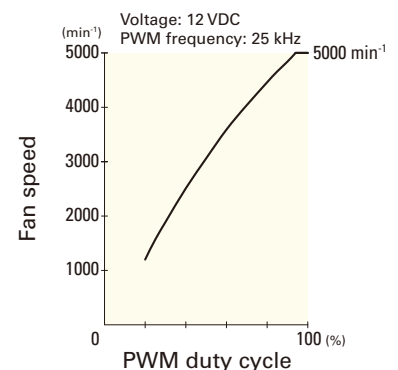
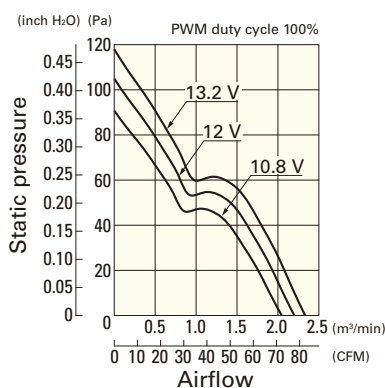
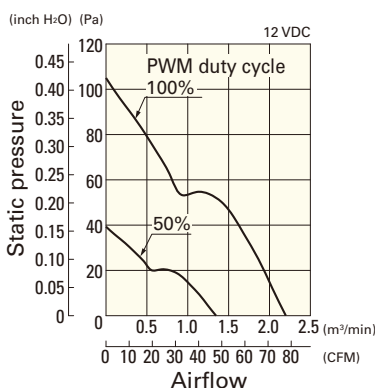

# Airflow - Static Pressure Characteristics / PWM Duty - Speed Characteristics Example

**9LG0912P4G001** With pulse sensor with PWM control function

PWM duty cycle

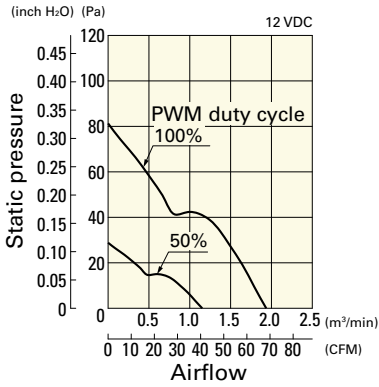

Operating voltage range

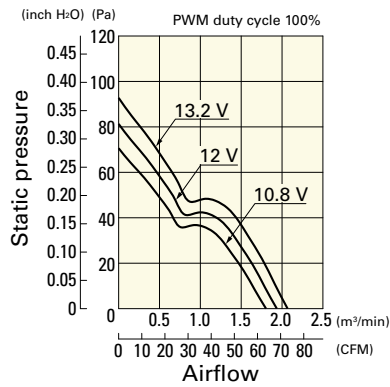

PWM duty - Speed characteristics example

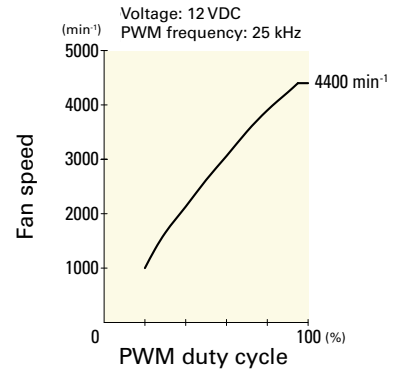

**9LG0912P4S001** With pulse sensor with PWM control function

PWM duty cycle

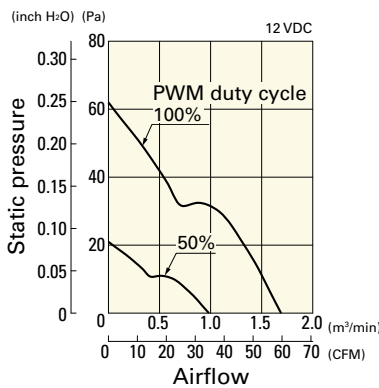

Operating voltage range

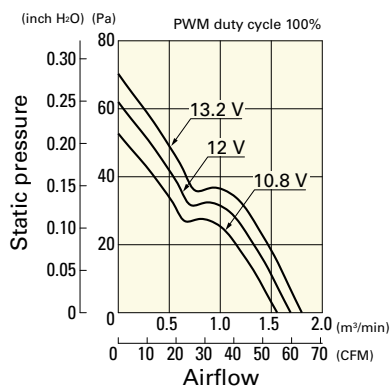

PWM duty - Speed characteristics example

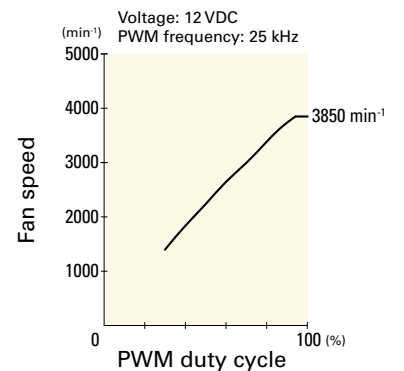

**9LG0912P4H001** With pulse sensor with PWM control function

PWM duty cycle

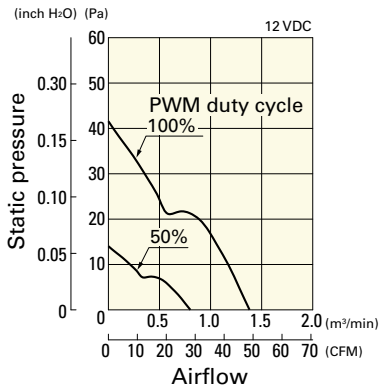

Operating voltage range

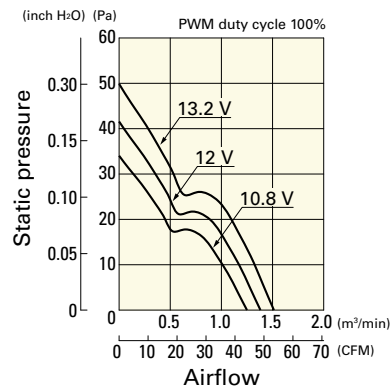

PWM duty - Speed characteristics example

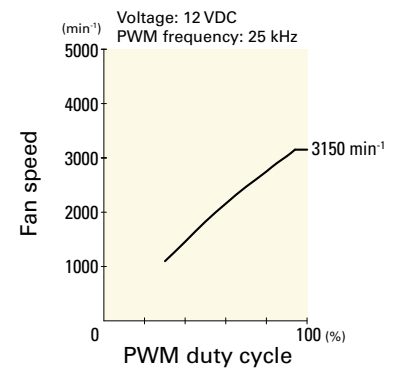

**9LG0924P4J001** With pulse sensor with PWM control function

PWM duty cycle

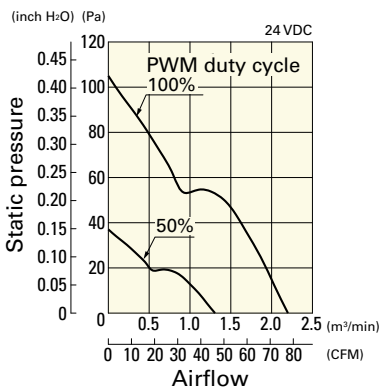

Operating voltage range

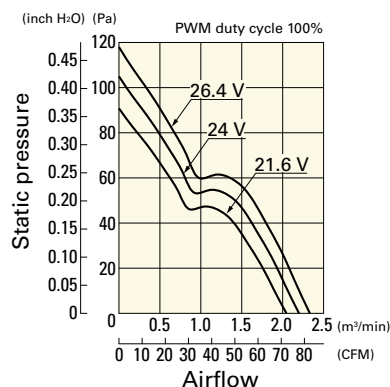

PWM duty - Speed characteristics example

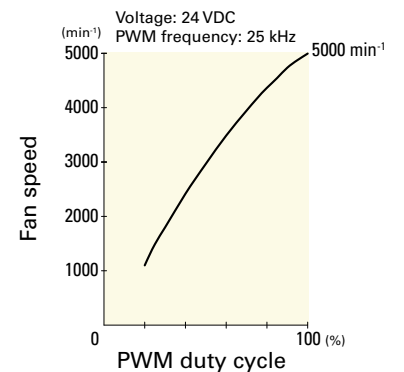

# Airflow - Static Pressure Characteristics / PWM Duty - Speed Characteristics Example

**9LG0924P4G001** With pulse sensor with PWM control function

PWM duty cycle

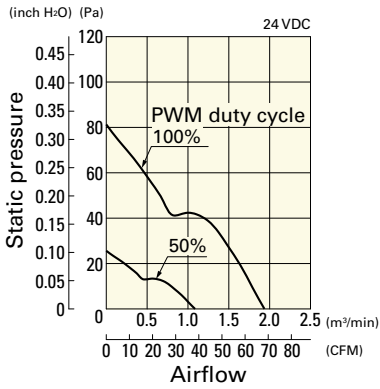

Operating voltage range

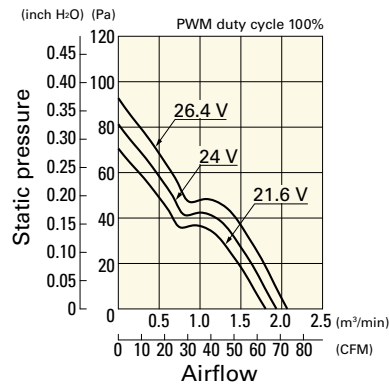

PWM duty - Speed characteristics example

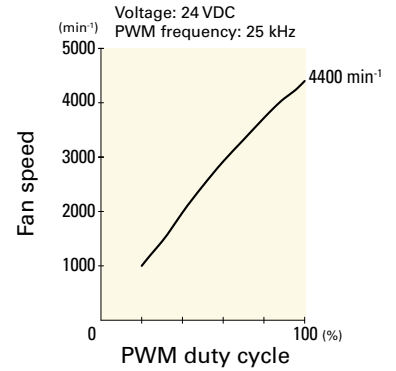

**9LG0924P4S001** With pulse sensor with PWM control function

PWM duty cycle

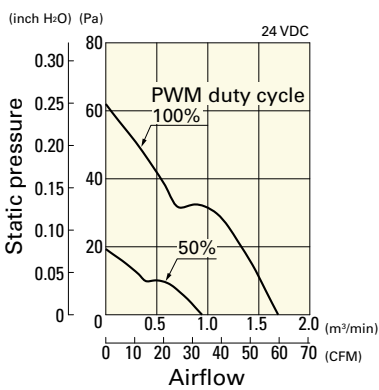

Operating voltage range

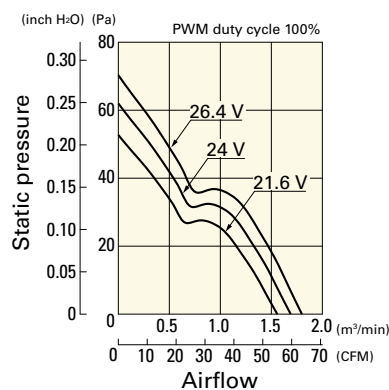

PWM duty - Speed characteristics example

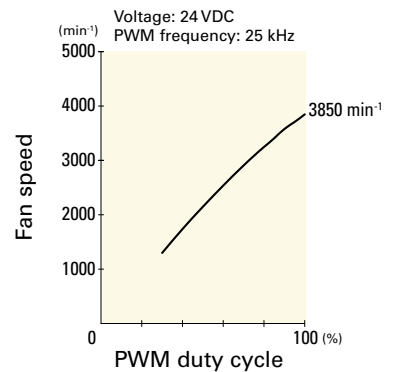

**9LG0924P4H001** With pulse sensor with PWM control function

PWM duty cycle

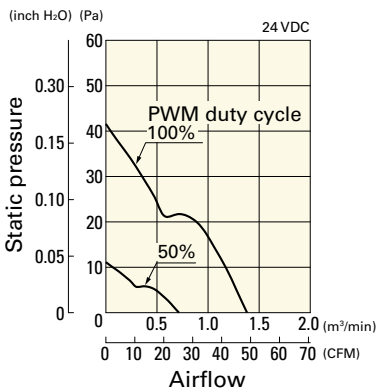

Operating voltage range

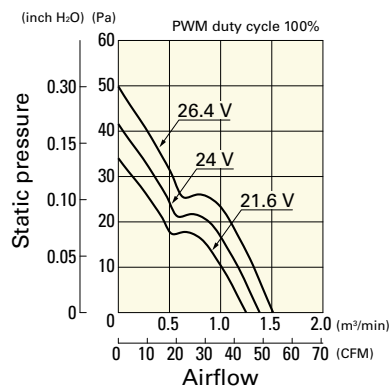

PWM duty - Speed characteristics example

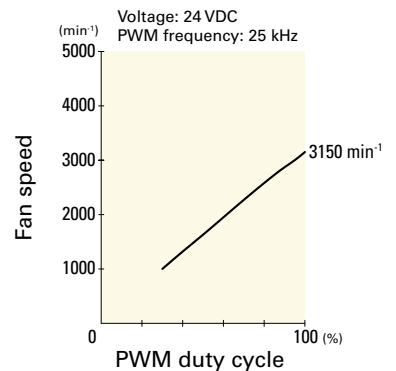

**9LG0912F4001** With pulse sensor

Operating voltage range

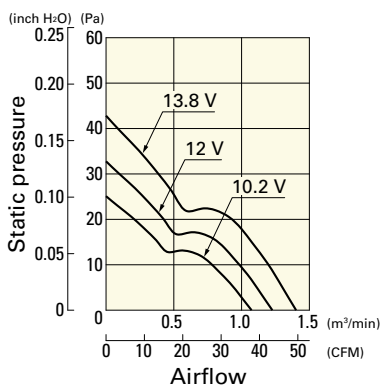

**9LG0912M4001** With pulse sensor

Operating voltage range

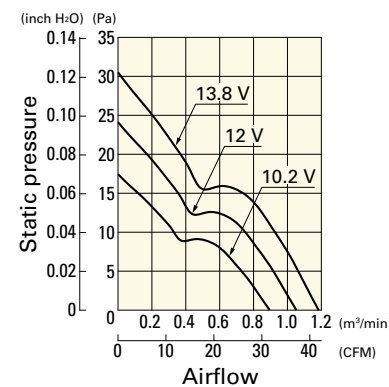

**9LG0912L4001** With pulse sensor

Operating voltage range

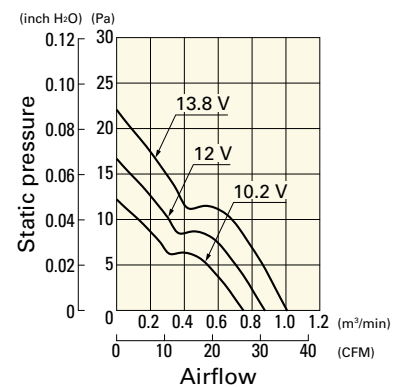

DC

Long Life Fan 92 mm sq.

## Airflow - Static Pressure Characteristics

**9LG0924F4001** With pulse sensor

Operating voltage range

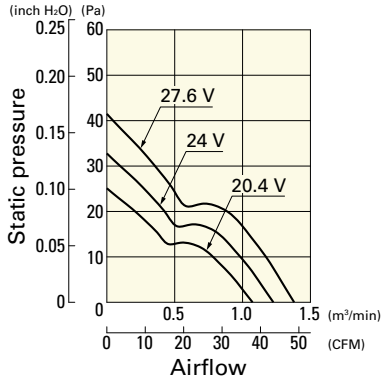

**9LG0924M4001** With pulse sensor

Operating voltage range

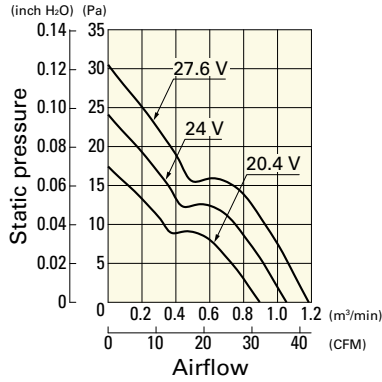

**9LG0924L4001** With pulse sensor

Operating voltage range

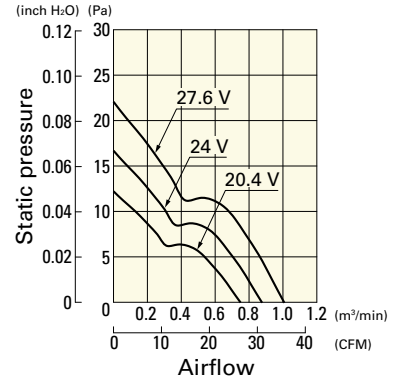

## Dimensions (unit: mm)

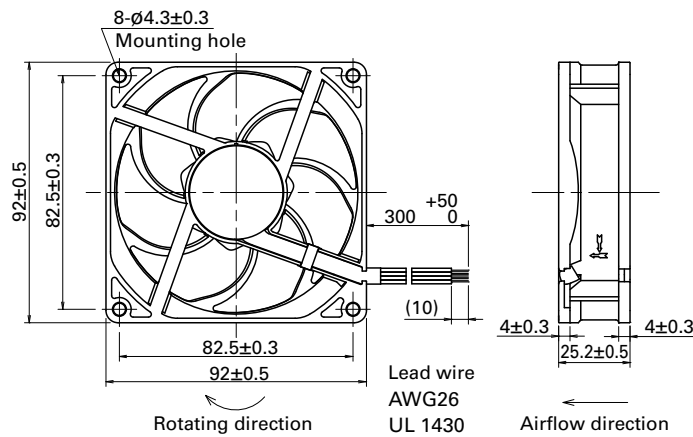

## Reference Dimensions of Mounting Holes and Vent Opening (unit: mm)

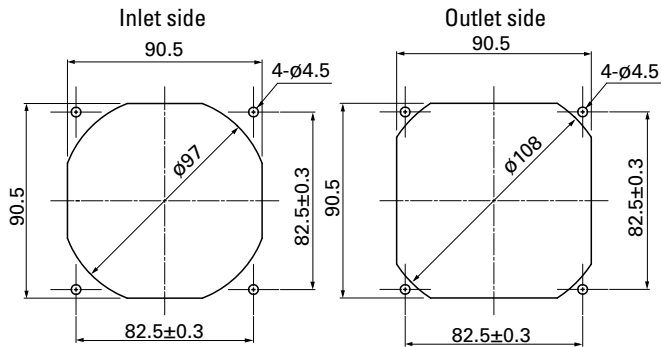

## Options

Finger guards

page: p. 532

Model no.: 109-099E, 109-099H, 109-099C

Resin finger guards

page: p. 539

Model no.: 109-1001G

Resin filter kits

page: p. 540

Model no.: 109-1001F13 (13PPI), 109-1001F20 (20PPI),  
109-1001F30 (30PPI), 109-1001F40 (40PPI)