



Dual-function (hour and watt-hour meter) 48 x 48 - CMM48 CEM48 Part number 99780714



- Dual-function counter (hour counter and watt-hour meter)
- Capacity 100,000 hrs (99,999.99 hrs)
- Remote readout via SO output
- Panel mounted
- IP 65
- Excellent visibility due to the large digit size

Part numbers

Type	Designation	Operating frequency (Hz)	Voltages
99780714 CEM48	Single-phase (max. 16 A)	50 / 60	230 VAC

Specifications

General characteristics

Counting capacity	99,999.9 hrs/99,999.9 kWh
Display by LED	LED backlight : the counter is powered up LED flashing : the energy is being measured
Reset to zero	Not included
Read accuracy	1/10 h
Height digits (mm)	4
Colour of hour numbers	White on a black background
Colour of decimal digits	Red on a black background
Accuracy	Hour counter : $\pm 2\%$ Watt-hour meter : Class B (1%)
Current	I _{max} : 16 A Current limits between 20 mA and 16 A Use for current > 20 mA
Degree of protection front face	IP65
Mounting	Any
Temperature limits use (°C)	- 20 → +55
Temperature limits stored (°C)	- 25 → +65
Certifications	CE
Connection	Screw terminals
Connection capacity	2,5 mm ²
Output signal	Watt-hour meter : : 1000 impulses/kWh, 5 → 30 VDC, I _{max} : 20 mA Hour counter : 10 impulses/hr, 5 → 30 VDC, I _{max} : 20 mA
Standards	EN 50470-1, EN 50470-3
Test voltage for AC models	2 000 VAC 50 Hz
Weight (g)	83

Accessories

Description	Code
Adaptor for 72 x 72 mm cut-out	26546842
Adaptor for 55 x 55 mm cut-out	26546846
DIN rail adaptor	26546841

Dimensions (mm)

Panel mounted

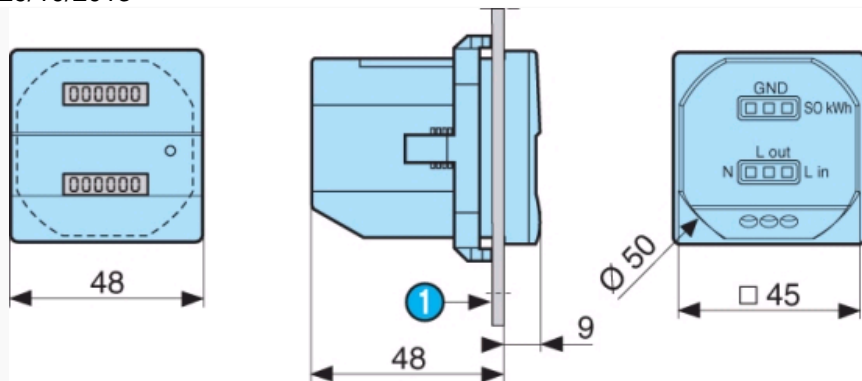

N°	Legend
1	9 max.

Dimensions (mm)

Panel cut-out

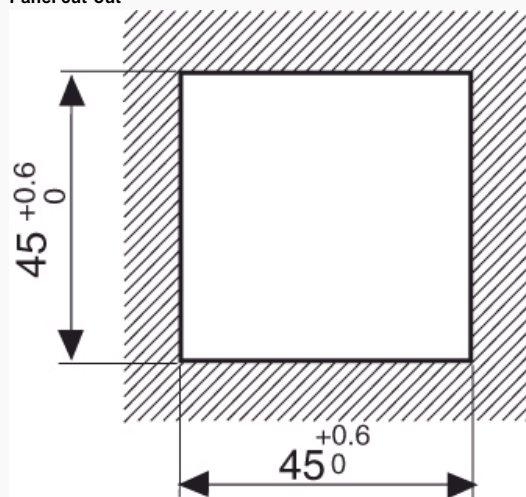

Dimensions (mm)

26546842 - Adaptor for 72 x 72 mm cut-out

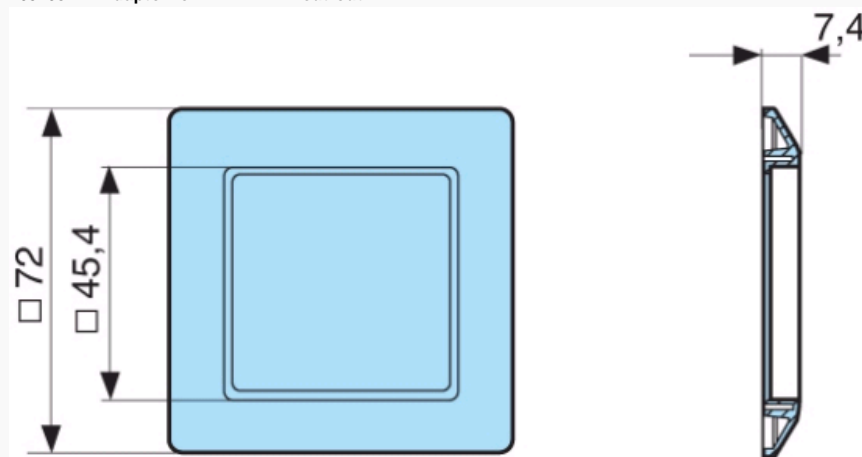

Dimensions (mm)

26546846 - Adaptor for 55 x 55 mm cut-out

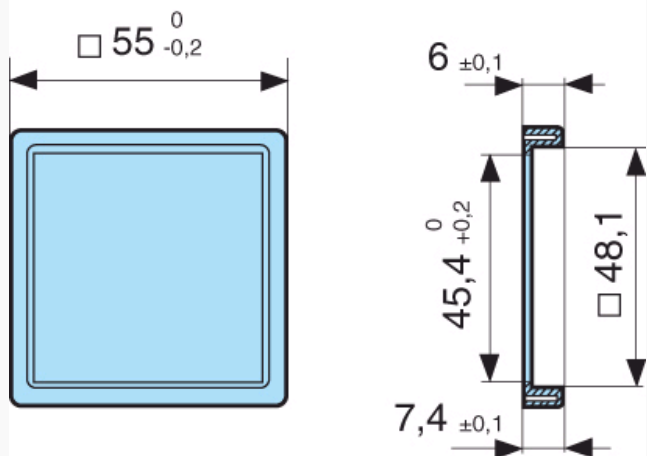

Dimensions (mm)

26546841 - DIN rail adaptor

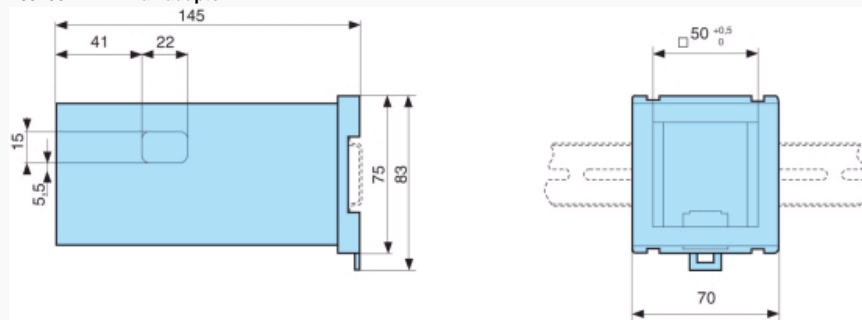

Connections

CEM48

