

936111-1 ✓ ACTIVE

Sealed Sensor Connector SSC System

TE Internal #: 936111-1

Automotive Connector Caps & Covers, Cover - Cable Exit, Cable Exit Angle 180°, Black, PA, 2 Position, Sealed Sensor Connector SSC System

[View on TE.com >](#)



Connectors > Automotive Connectors > Automotive Connector Accessories > Automotive Connector Caps & Covers



Protection & Strain Relief Accessory Type: **Cover - Cable Exit**

Cable Exit Angle: **180°**

Strain Relief: **With**

Primary Product Color: **Black**

Primary Product Material: **PA**

Features

Product Type Features

Protection & Strain Relief Accessory Type	Cover - Cable Exit
---	--------------------

Configuration Features

Number of Positions	2
---------------------	---

Body Features

Cable Exit Angle	180°
------------------	------

Primary Product Color	Black
-----------------------	-------

Primary Product Material	PA
--------------------------	----

Mechanical Attachment

Strain Relief	With
---------------	------

Dimensions

Compatible Cable Bundle Diameter Range	8 mm[.315 in]
--	---------------

Usage Conditions

Operating Temperature (Max)	70 °C, 75 °C, 80 °C, 85 °C, 90 °C, 100 °C, 105 °C, 110 °C, 120 °C[158 °F][167 °F][176 °F][185 °F][194 °F][212 °F][221 °F][230 °F][248 °F]
-----------------------------	---

Operating Temperature Range	-40 – 120 °C[-40 – 248 °F]
-----------------------------	----------------------------

Industry Standards



UL Flammability Rating	UL 94HB
------------------------	---------

Packaging Features

Packaging Quantity	500
Packaging Method	Bag

Other

Serviceable	Yes
-------------	-----

Product Compliance

[For compliance documentation, visit the product page on TE.com>](#)

EU RoHS Directive 2011/65/EU	Compliant
EU ELV Directive 2000/53/EC	Compliant
China RoHS 2 Directive MIIT Order No 32, 2016	No Restricted Materials Above Threshold
EU REACH Regulation (EC) No. 1907/2006	Current ECHA Candidate List: JUNE 2023 (235) Candidate List Declared Against: JUNE 2023 (235) Does not contain REACH SVHC
Halogen Content	Low Halogen - Br, Cl, F, I < 900 ppm per homogenous material. Also BFR/CFR/PVC Free
Solder Process Capability	Not applicable for solder process capability

Product Compliance Disclaimer

This information is provided based on reasonable inquiry of our suppliers and represents our current actual knowledge based on the information they provided. This information is subject to change. The part numbers that TE has identified as EU RoHS compliant have a maximum concentration of 0.1% by weight in homogenous materials for lead, hexavalent chromium, mercury, PBB, PBDE, DBP, BBP, DEHP, DIBP, and 0.01% for cadmium, or qualify for an exemption to these limits as defined in the Annexes of Directive 2011/65/EU (RoHS2). Finished electrical and electronic equipment products will be CE marked as required by Directive 2011/65/EU. Components may not be CE marked. Additionally, the part numbers that TE has identified as EU ELV compliant have a maximum concentration of 0.1% by weight in homogenous materials for lead, hexavalent chromium, and mercury, and 0.01% for cadmium, or qualify for an exemption to these limits as defined in the Annexes of Directive 2000/53/EC (ELV). Regarding the REACH Regulation, the information TE provides on SVHC in articles for this part number is based on the latest European Chemicals Agency (ECHA) 'Guidance on requirements for substances in articles' posted at this URL: <https://echa.europa.eu/guidance-documents/guidance-on-reach>

Compatible Parts



Also in the Series | Sealed Sensor Connector SSC System

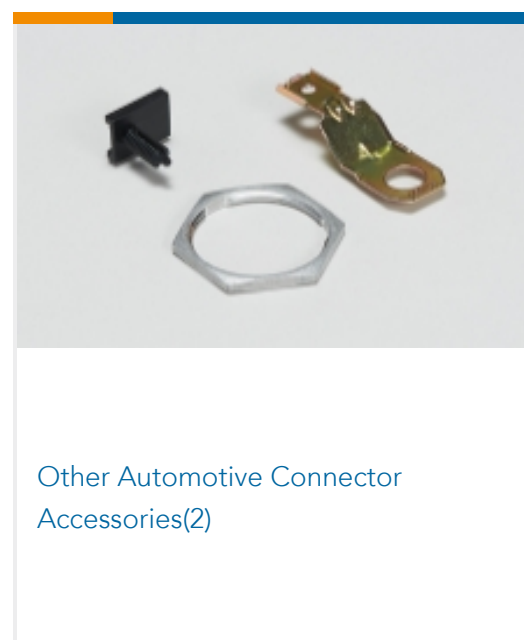
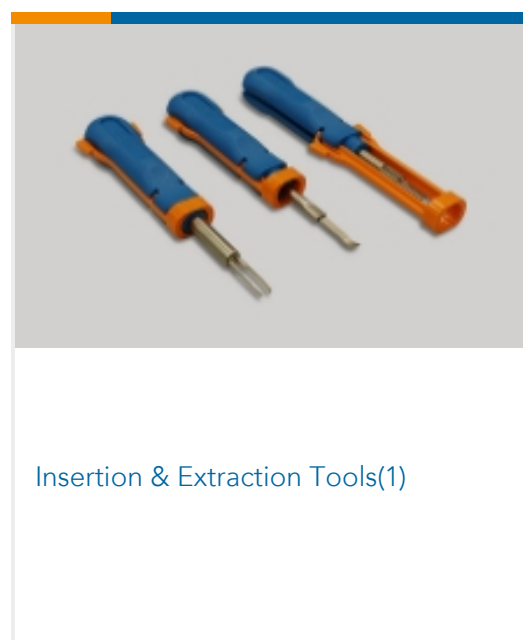
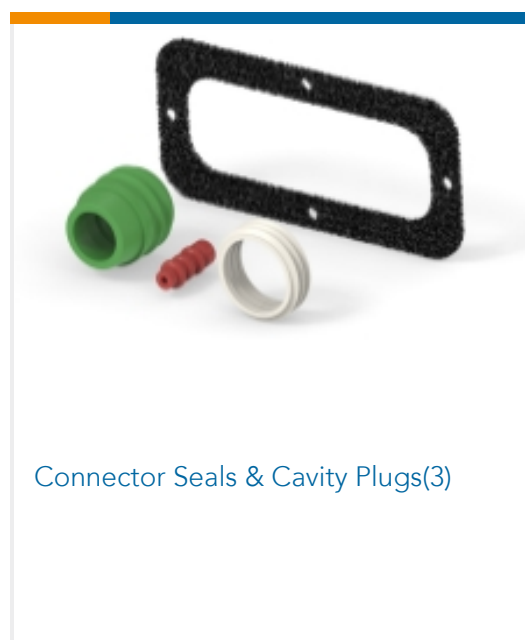
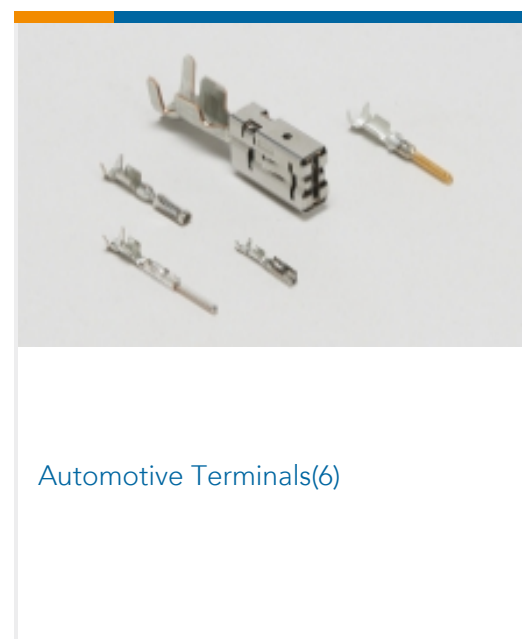
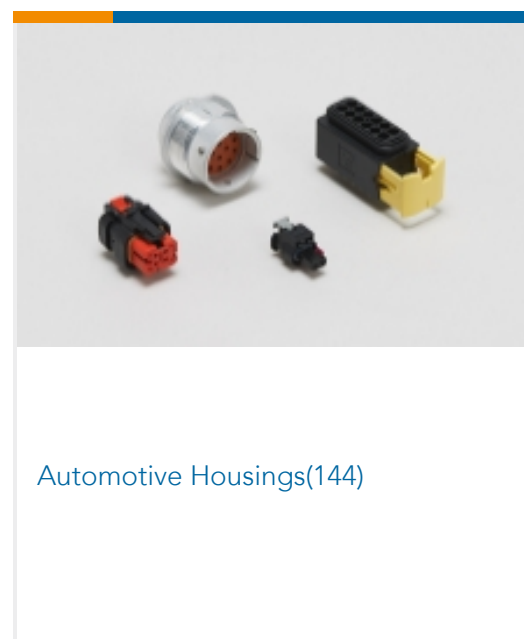
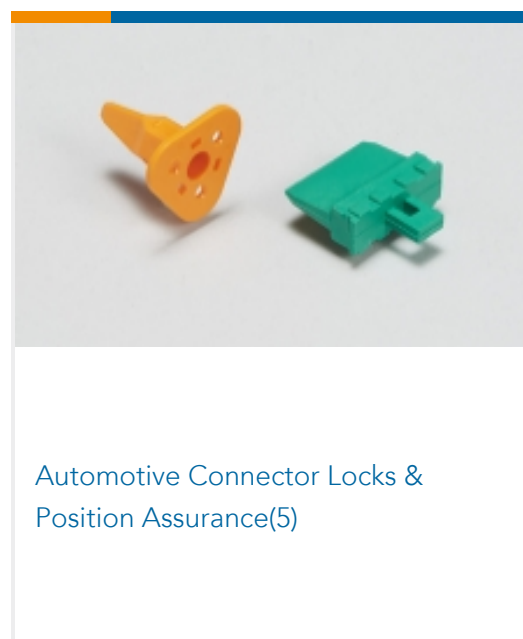
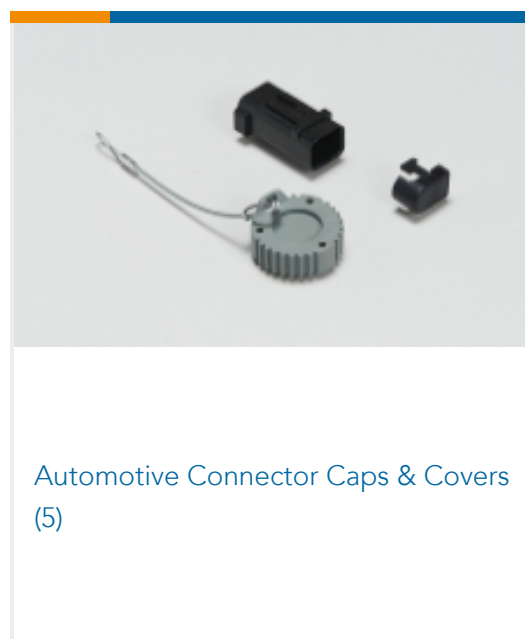

Customers Also Bought



TE Part #1452997-1
76 POS 2-NDRAY LOCK BIG

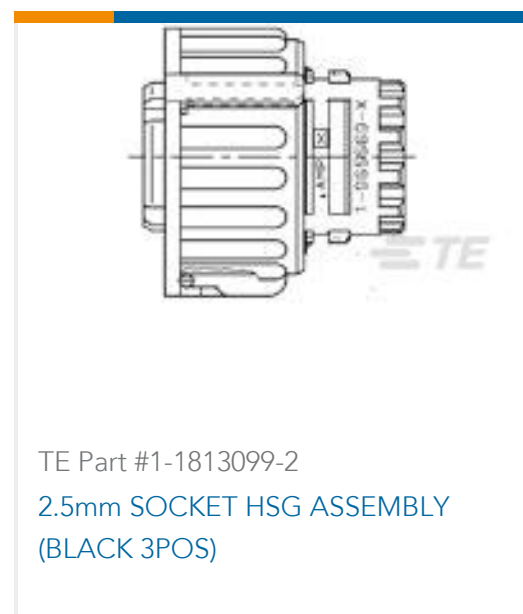

TE Part #1-1813099-2
2.5mm SOCKET HSG ASSEMBLY
(BLACK 3POS)



TE Part #927772-3
JPT REC 2.8 Contact SWS Sn



TE Part #368260-1
CLIP HSG FOR 090 II MLC



TE Part #1-1452424-2
BLIND PLUG FOR MCON 1.2 CB (1.

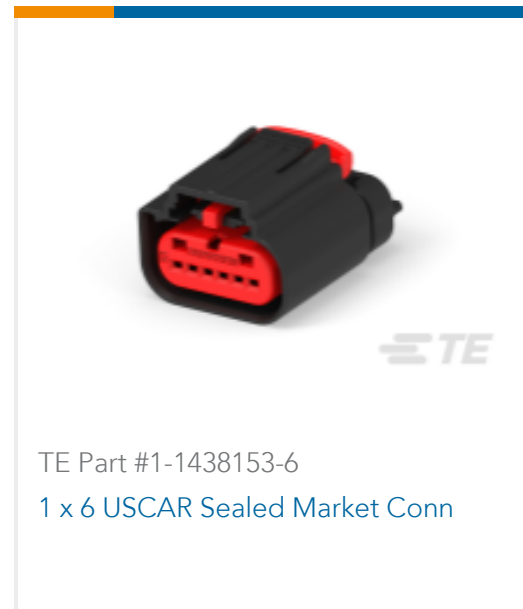

TE Part #1-1438153-6
1 x 6 USCAR Sealed Market Conn



TE Part #1-368354-2
JPT 2P ASSY FOR CLIP BLK



TE Part #2050046-4
2POS 2.8MM SENSOR PLUG ASSY.

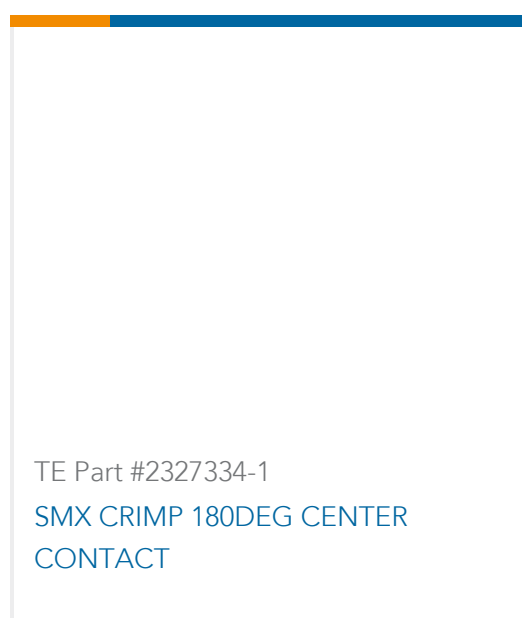

TE Part #2327334-1
SMX CRIMP 180DEG CENTER
CONTACT



TE Part #2354251-2
SMX CRIMP FERRULE

Documents

Product Drawings

2.8mm Sealed 2P Cover

English

CAD Files

3D PDF

3D

Customer View Model

[ENG_CVM_CVM_936111-1_B.2d_dxf.zip](#)

English

Customer View Model

[ENG_CVM_CVM_936111-1_B.3d_igs.zip](#)

English

Customer View Model

[ENG_CVM_CVM_936111-1_B.3d_stp.zip](#)

English

By downloading the CAD file I accept and agree to the [Terms and Conditions](#) of use.

Product Specifications



[2.8MM series](#)

English