



Sealed Sensor Connector SSC System

TE Internal #: 936059-2

Wire-to-Device / Wire-to-Board, 2 Position, .197 in [5 mm]

Centerline, Sealable, Black, Signal, Sealed Sensor Connector SSC System

[View on TE.com >](#)

Connectors > Automotive Connectors > Automotive Housings

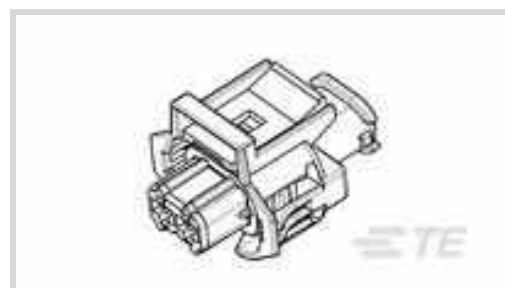

Mating Tab Width: 2.8 mm [.11 in]

Connector System: **Wire-to-Board, Wire-to-Device**

Number of Positions: 2

Centerline (Pitch): 5 mm [.197 in]

Sealable: **Yes**

Features

Product Type Features

Connector Shape	Rectangular
Connector System	Wire-to-Board, Wire-to-Device
Sealable	Yes
Hybrid Connector	No

Configuration Features

Number of Positions	2
Number of Rows	1

Body Features

Primary Product Color	Black
Connector & Keying Code	I

Contact Features

Contact Size	2.8mm
Mating Tab Width	2.8 mm[.11 in]

Mechanical Attachment

Terminal Position Assurance	No
Strain Relief	Without
Mating Alignment Type	Keyed
Mating Alignment	With



Connector Mounting Type	Cable Mount (Free-Hanging)
-------------------------	----------------------------

Housing Features

Housing Material	PA GF
Centerline (Pitch)	5 mm [.197 in]

Dimensions

Connector Height	30.5 mm [1.201 in]
Product Width	20.1 mm [.791 in]
Product Length	25 mm [.984 in]

Operation/Application

Circuit Application	Signal
---------------------	--------

Packaging Features

Packaging Quantity	200
Packaging Method	Bag

Other

Serviceable	No
Connector Position Assurance Capable	No

Product Compliance

[For compliance documentation, visit the product page on TE.com>](#)

EU RoHS Directive 2011/65/EU	Compliant
EU ELV Directive 2000/53/EC	Compliant
China RoHS 2 Directive MIIT Order No 32, 2016	No Restricted Materials Above Threshold
EU REACH Regulation (EC) No. 1907/2006	Current ECHA Candidate List: JUNE 2022 (224) Candidate List Declared Against: JUNE 2022 (224) Does not contain REACH SVHC
Halogen Content	BFR/CFR/PVC Free, but Br/Cl >900 ppm in other sources.
Solder Process Capability	Not applicable for solder process capability

Product Compliance Disclaimer

This information is provided based on reasonable inquiry of our suppliers and represents our current actual knowledge based on the information they provided. This information is subject to change. The part numbers that TE has identified as EU RoHS compliant have a maximum concentration of 0.1% by weight in homogenous materials for lead, hexavalent chromium, mercury, PBB, PBDE, DBP, BBP, DEHP, DIBP, and 0.01% for cadmium, or qualify for an exemption to these limits as defined in the Annexes of Directive 2011/65/EU (RoHS2). Finished electrical and electronic equipment products

will be CE marked as required by Directive 2011/65/EU. Components may not be CE marked. Additionally, the part numbers that TE has identified as EU ELV compliant have a maximum concentration of 0.1% by weight in homogenous materials for lead, hexavalent chromium, and mercury, and 0.01% for cadmium, or qualify for an exemption to these limits as defined in the Annexes of Directive 2000/53/EC (ELV). Regarding the REACH Regulation, the information TE provides on SVHC in articles for this part number is based on the latest European Chemicals Agency (ECHA) 'Guidance on requirements for substances in articles' posted at this URL: <https://echa.europa.eu/guidance-documents/guidance-on-reach>

Compatible Parts



TE Part # 936103-1
2.8MM SLD 2P PLUG RETAINER YEL



TE Part # 828905-1
SINGLE-WIRE-SEAL(5MM HOLE)



TE Part # 828904-1
SINGLE WIRE SEAL FOR J.P.T.CON



TE Part # 936462-2
2.8MM SLD 2P CAP HSG



TE Part # CAT-AM706-T273
AMP MCP, SFC, RECEPTACLE



TE Part # 936111-1
2.8mm Sealed 2P Cover



TE Part # 1743544-2
COVER HSG FOR 2.8MM SLD 2P



TE Part # 936103-2
2.8MM SLD 2P PLUG RETAINER BLK



TE Part # 936103-3
2.8MM SLD 2P PLUG RETAINER GRY



TE Part # 936462-1
2.8MM SLD 2P CAP HSG NAT



TE Part # 1743451-2
COVER HSG FOR 2.8MM SLD 2P

Also in the Series | Sealed Sensor Connector SSC System



Automotive Connector Caps & Covers (7)



Automotive Connector Locks & Position Assurance(6)



Automotive Housings(174)



Automotive Seals & Cavity Plugs(3)



Automotive Terminals(8)



Insertion & Extraction Tools(1)



Other Automotive Connector Accessories(5)

Customers Also Bought

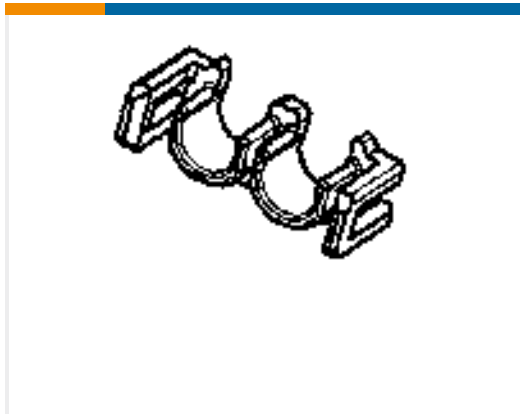

TE Part #936103-1
2.8MM SLD 2P PLUG RETAINER YEL

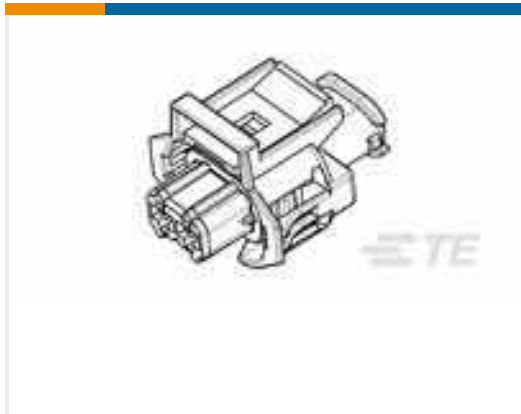

TE Part #936394-2
2.8MM SLD 6P PLUG ASSY



TE Part #927772-3
JPT REC 2.8 Contact SWS Sn



TE Part #1745032-1
2 POS. MCP2.8 CONNECTOR FOR IGNITION KEY



TE Part #936111-1
2.8mm Sealed 2P Cover



TE Part #1-936059-3
2.8MM SLD 2P PLUG ASSY



TE Part #1-368354-2
JPT 2P ASSY FOR CLIP BLK



TE Part #2296998-2
GET 6P PLUG COVER HSG

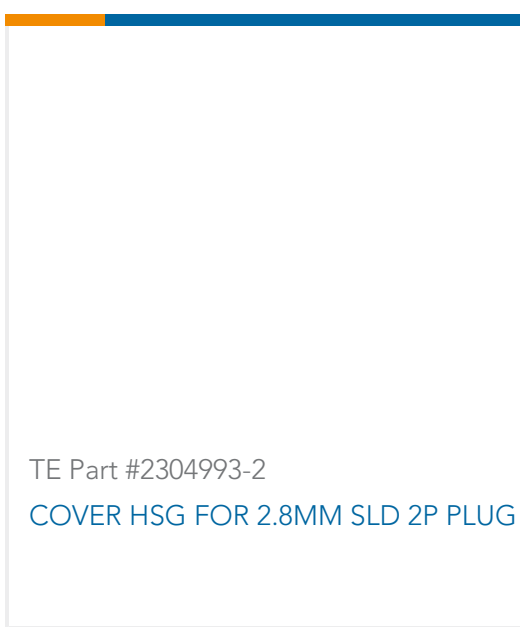

TE Part #2304993-2
COVER HSG FOR 2.8MM SLD 2P PLUG

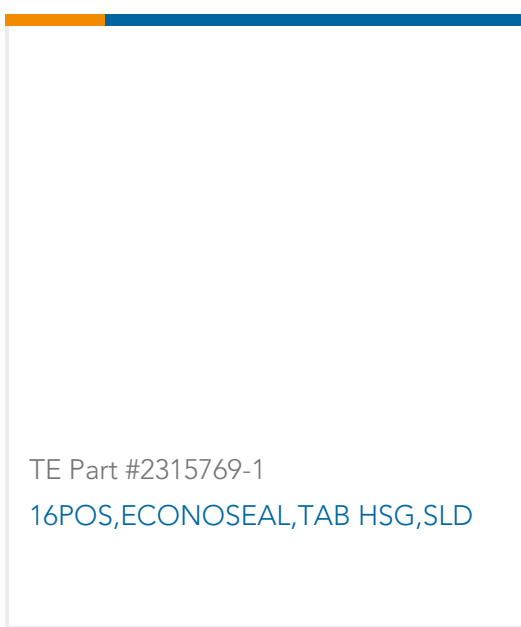

TE Part #2315769-1
16POS,ECONOSEAL,TAB HSG,SLD

Documents

Product Drawings

[2.8MM SLD 2P PLUG ASSY](#)

English

CAD Files

[Customer View Model](#)

[ENG_CVM_CVM_936059-2_D.2d_dxf.zip](#)

English

[3D PDF](#)



3D

Customer View Model

[ENG_CVM_CVM_936059-2_D.3d_igs.zip](#)

English

Customer View Model

[ENG_CVM_CVM_936059-2_D.3d_stp.zip](#)

English

By downloading the CAD file I accept and agree to the [Terms and Conditions](#) of use.

Product Specifications

[2.8MM series](#)

English