



MATE-N-LOK | Commercial MATE-N-LOK

TE Internal #: 926988-2

Pin Contact, Tin, 250 VAC, Locking Lance Contact Retention, 20 – 15 AWG Wire Size, .52 – 1.65 mm² Wire Size, Crimp, Commercial MATE-N-LOK

[View on TE.com >](#)

Connectors > Contacts > Connector Contacts

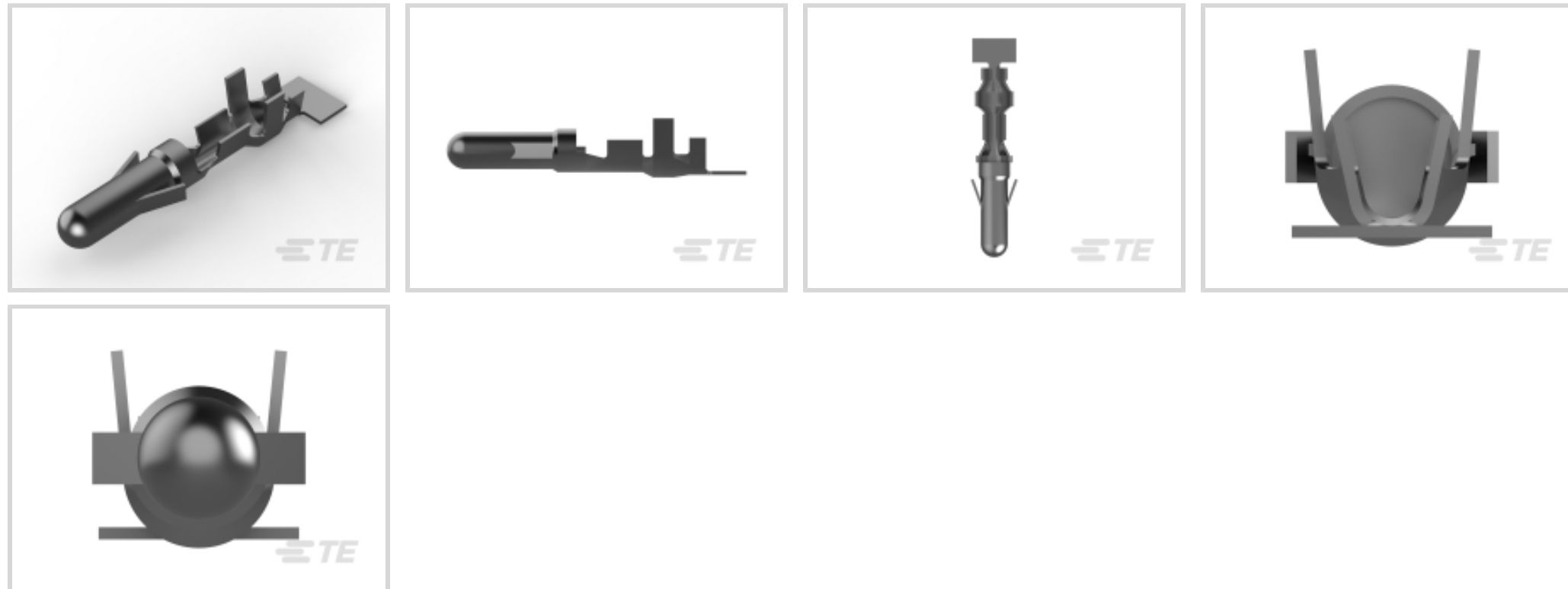

Contact Type: **Pin**

Contact Mating Area Plating Material: **Tin**

Wire Contact Termination Area Plating Material: **Pre-Tin**

Operating Voltage: **250 VAC**

Contact Retention Within Housing: **With**

Features

Electrical Characteristics

Operating Voltage	250 VAC
-------------------	---------

Contact Features

Mating Pin Diameter	3.56 mm [.14 in]
Wire Contact Termination Area Plating Material Finish	Bright
Contact Orientation	Straight
Contact Type	Pin
Contact Mating Area Plating Material	Tin
Wire Contact Termination Area Plating Material	Pre-Tin
Contact Retention Within Housing	With
Contact Base Material	Phosphor Bronze
Contact Current Rating (Max)	17 A

Termination Features

Termination Method to Wire & Cable	Crimp
Product Terminates To	Wire & Cable



Mechanical Attachment

Wire Insulation Support	Without
Contact Retention Type Within Housing	Locking Lance

Dimensions

Compatible Insulation Diameter Range	1.02 – 2.4 mm [.047 – .094 in]
Wire Size	.52 – 1.65 mm ²

Usage Conditions

Operating Temperature Range	-55 – 105 °C [-67 – 221 °F]
-----------------------------	-----------------------------

Operation/Application

Circuit Application	Power
---------------------	-------

Packaging Features

Packaging Quantity	7500
Packaging Method	Carton

Product Compliance

[For compliance documentation, visit the product page on TE.com>](#)

EU RoHS Directive 2011/65/EU	Compliant
EU ELV Directive 2000/53/EC	Compliant
China RoHS 2 Directive MIIT Order No 32, 2016	No Restricted Materials Above Threshold
EU REACH Regulation (EC) No. 1907/2006	Current ECHA Candidate List: JUNE 2023 (235) Candidate List Declared Against: JUNE 2023 (235) Does not contain REACH SVHC
Halogen Content	Low Halogen - Br, Cl, F, I < 900 ppm per homogenous material. Also BFR/CFR/PVC Free
Solder Process Capability	Not applicable for solder process capability

Product Compliance Disclaimer

This information is provided based on reasonable inquiry of our suppliers and represents our current actual knowledge based on the information they provided. This information is subject to change. The part numbers that TE has identified as EU RoHS compliant have a maximum concentration of 0.1% by weight in homogenous materials for lead, hexavalent chromium, mercury, PBB, PBDE, DBP, BBP, DEHP, DIBP, and 0.01% for cadmium, or qualify for an exemption to these limits as defined in the Annexes of Directive 2011/65/EU (RoHS2). Finished electrical and electronic equipment products will be CE marked as required by Directive 2011/65/EU. Components may not be CE marked. Additionally, the part numbers that TE has identified as EU ELV compliant have a maximum concentration of 0.1% by weight in homogenous materials for lead, hexavalent chromium, and mercury, and 0.01% for cadmium, or qualify for an exemption to these limits as defined in the Annexes of Directive 2000/53/EC (ELV). Regarding the REACH Regulation, the information TE provides

on SVHC in articles for this part number is based on the latest European Chemicals Agency (ECHA) 'Guidance on requirements for substances in articles' posted at this URL: <https://echa.europa.eu/guidance-documents/guidance-on-reach>

Compatible Parts



TE Part # 1-480586-0
09P .140 MNL CAP NAT



TE Part # 1-350347-0
03P .140 MNL CAP PM NAT



TE Part # 1-480673-0
09P .140 MNL CAP PM NAT



TE Part # 1-350345-0
02P .140 MNL CAP P/M NAT



TE Part # 1-480512-0
04P .140 MNL CAP NAT



TE Part # 794683-1
09P .140 MNL CAP BLK HT



TE Part # 539764-1
EXTRACTION TOOL



TE Part # 925450-1
M-N-L PIN HSG

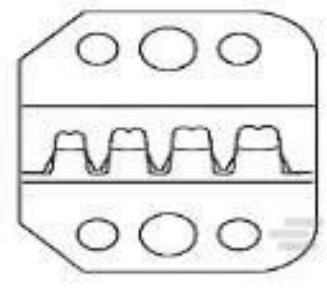

TE Part # 1752938-2
SDE DIE SET 3.5 MM MNL



TE Part # 2151475-1
OCEAN_2.0_Applicator-S-100F110F



TE Part # 2151475-2
OCEAN_2.0_Applicator-S-100F110F



TE Part # 2305570-1
Strip Terminal Cutter-Side Feed-No Crimp



TE Part # 7-2151475-1
OCEAN_2.0_Applicator-S-100F110F



TE Part # 7-2151475-2
OCEAN_2.0_Applicator-S-100F110F



TE Part # 7-2151475-7
OCEAN_2.0_SPARE_PART_KIT-100F110F



TE Part # 794061-1
03P .140 MNL CAP BLK HT

Also in the Series | Commercial MATE-N-LOK

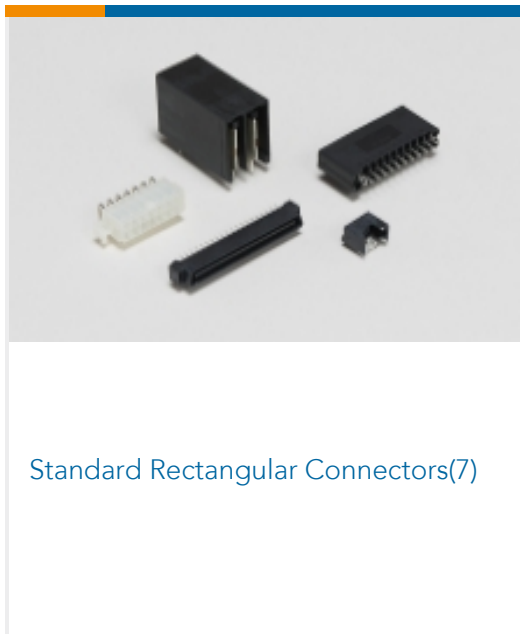
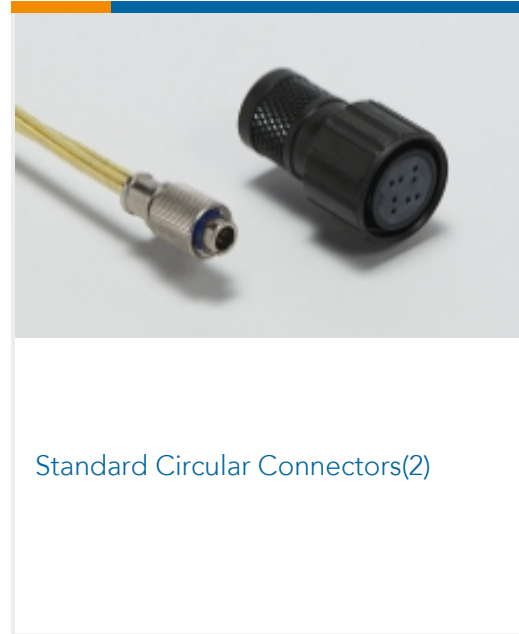
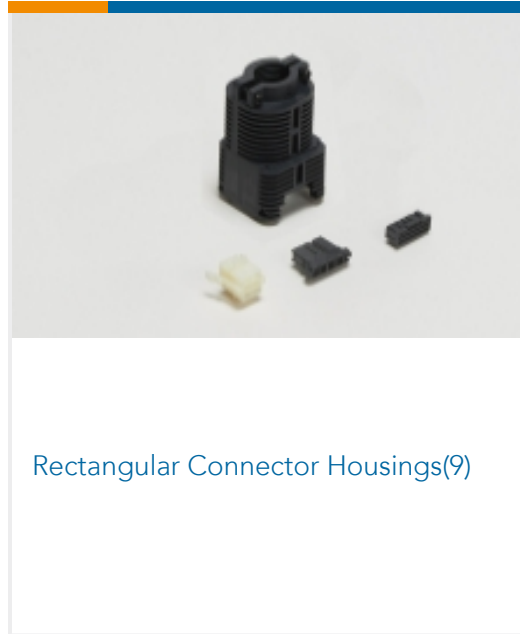
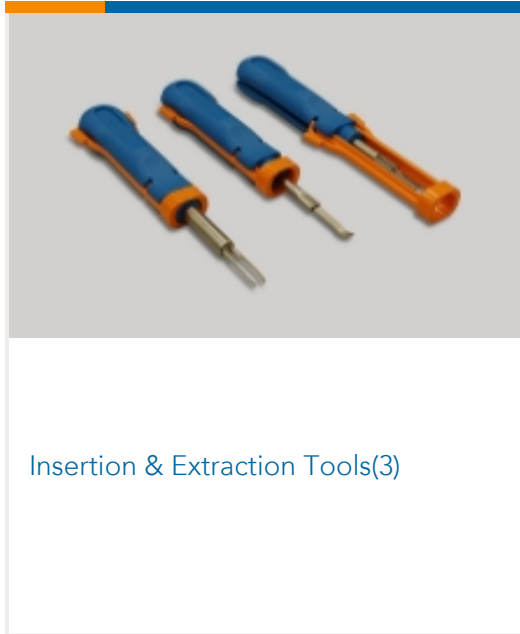
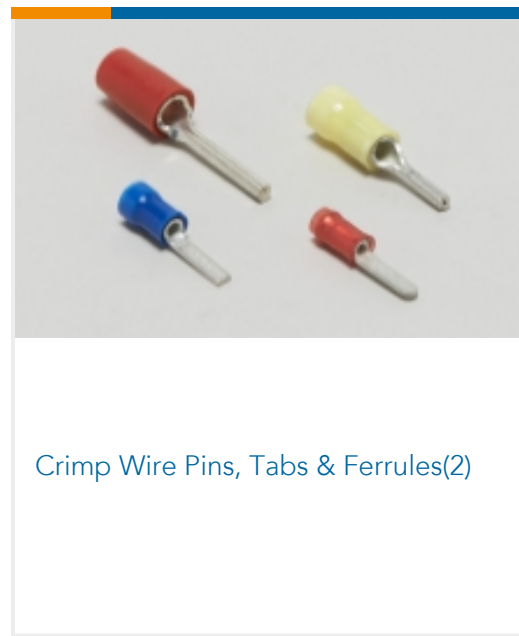
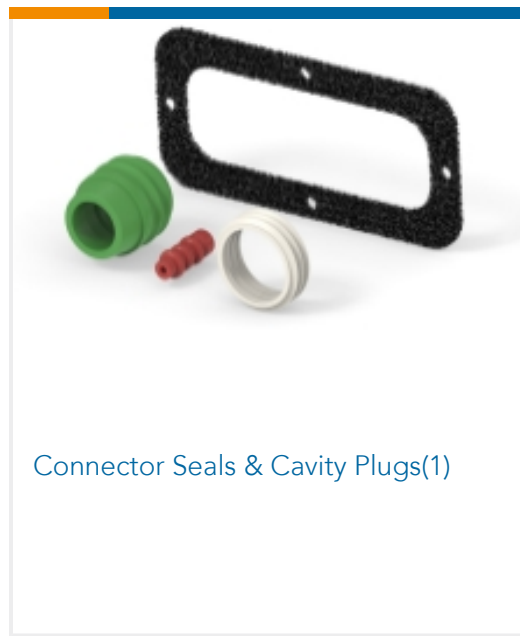
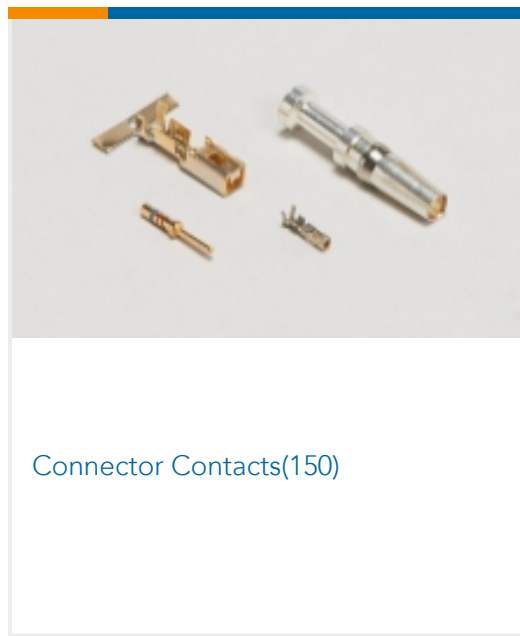

Customers Also Bought



Documents



Product Drawings

MNL STIFT 3,5 MM

English

CAD Files

3D PDF

English

Customer View Model

[ENG_CVM_926988-2_A1.2d_dxf.zip](#)

English

Customer View Model

[ENG_CVM_926988-2_A1.3d_igs.zip](#)

English

Customer View Model

[ENG_CVM_926988-2_A1.3d_stp.zip](#)

English

By downloading the CAD file I accept and agree to the [Terms and Conditions](#) of use.

Product Specifications

Product Specification

English