

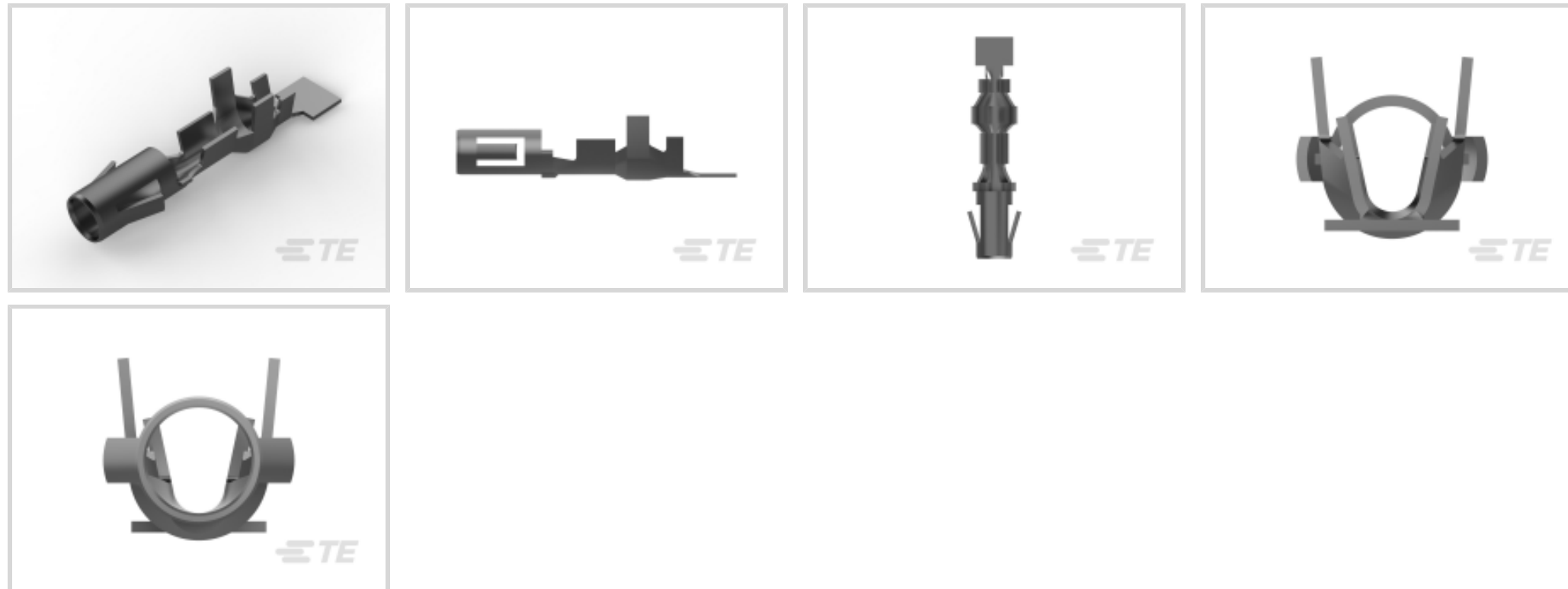

Connectors > Contacts > Connector Contacts



Contact Type: **Socket**

Contact Mating Area Plating Material: **Tin**

Wire Contact Termination Area Plating Material: **Pre-Tin**

Operating Voltage: **250 VAC**

Contact Retention Within Housing: **With**

## Features

### Configuration Features

Compatible With Wire & Cable Type	Discrete Wire
-----------------------------------	---------------

### Electrical Characteristics

Operating Voltage	250 VAC
-------------------	---------

### Contact Features

Contact Diameter	3.56 mm[.14 in]
Contact Type	Socket
Contact Mating Area Plating Material	Tin
Wire Contact Termination Area Plating Material	Pre-Tin
Contact Retention Within Housing	With
Contact Base Material	Phosphor Bronze
Contact Current Rating (Max)	28 A

### Termination Features

Termination Method to Wire & Cable	Crimp
Product Terminates To	Wire & Cable



### Mechanical Attachment

Contact Retention Type Within Housing	Locking Lance
---------------------------------------	---------------

### Dimensions

Compatible Insulation Diameter Range	1.2 – 2.39 mm [.047 – .094 in]
Wire Size	.5 – 1.5 mm <sup>2</sup>

### Usage Conditions

Operating Temperature Range	-55 – 105 °C [-67 – 221 °F]
-----------------------------	-----------------------------

### Operation/Application

Circuit Application	Power
---------------------	-------

### Packaging Features

Packaging Quantity	2500
Packaging Method	Carton

### Product Compliance

[For compliance documentation, visit the product page on TE.com>](#)

EU RoHS Directive 2011/65/EU	Compliant
EU ELV Directive 2000/53/EC	Compliant
China RoHS 2 Directive MIIT Order No 32, 2016	No Restricted Materials Above Threshold
EU REACH Regulation (EC) No. 1907/2006	Current ECHA Candidate List: JUNE 2024 (241) Candidate List Declared Against: JAN 2024 (240) Does not contain REACH SVHC
Halogen Content	Low Halogen - Br, Cl, F, I < 900 ppm per homogenous material. Also BFR/CFR/PVC Free
Solder Process Capability	Not applicable for solder process capability

#### Product Compliance Disclaimer

This information is provided based on reasonable inquiry of our suppliers and represents our current actual knowledge based on the information they provided. This information is subject to change. The part numbers that TE has identified as EU RoHS compliant have a maximum concentration of 0.1% by weight in homogenous materials for lead, hexavalent chromium, mercury, PBB, PBDE, DBP, BBP, DEHP, DIBP, and 0.01% for cadmium, or qualify for an exemption to these limits as defined in the Annexes of Directive 2011/65/EU (RoHS2). Finished electrical and electronic equipment products will be CE marked as required by Directive 2011/65/EU. Components may not be CE marked. Additionally, the part numbers that TE has identified as EU ELV compliant have a maximum concentration of 0.1% by weight in homogenous materials for lead, hexavalent chromium, and mercury, and 0.01% for cadmium, or qualify for an exemption to these limits as defined in the Annexes of Directive 2000/53/EC (ELV). Regarding the REACH Regulation, the information TE provides

on SVHC in articles for this part number is based on the latest European Chemicals Agency (ECHA) 'Guidance on requirements for substances in articles' posted at this URL: <https://echa.europa.eu/guidance-documents/guidance-on-reach>

## Compatible Parts



TE Part # 539764-1  
EXTRACTION TOOL



TE Part # 1-480585-0  
09P .140 MNL PLUG NAT



TE Part # 1-350346-0  
03P .140 MNL PLUG P/M NAT



TE Part # 1-480672-0  
09P .140 MNL PLUG PM NAT



TE Part # 1-480510-0  
04P .140 MNL PLUG NAT



TE Part # 1-350344-0  
02P .140 MNL PLUG NAT



TE Part # 925451-1  
M-N-L SOCKET HSG



TE Part # 1-480672-9  
09P .140 MNL PLUG PM BLK

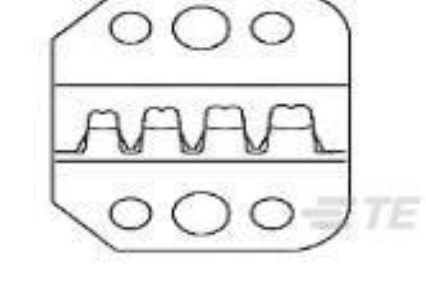

TE Part # 1752938-2  
SDE DIE SET 3.5 MM MNL



TE Part # 2151475-1  
OCEAN\_2.0\_Applicator-S-100F110F-RSM



TE Part # 2151475-2  
OCEAN\_2.0\_Applicator-S-100F110F-RSA



TE Part # 2305570-1  
Strip Terminal Cutter-Side Feed-No Crimp



**KIT**  
TE Part # 7-2151475-7  
OCEAN\_2.0\_SPARE\_PART\_KIT-100F110F



TE Part # 7-2151475-1  
OCEAN\_2.0\_Applicator-S-100F110F



TE Part # 7-2151475-2  
OCEAN\_2.0\_Applicator-S-100F110F

## Also in the Series | Commercial MATE-N-LOK

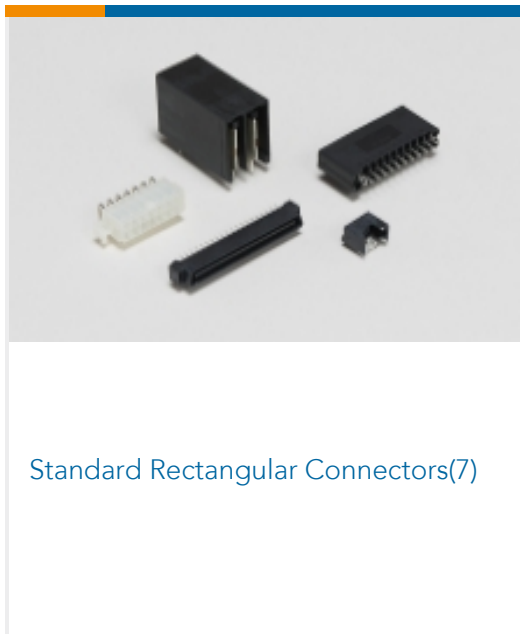
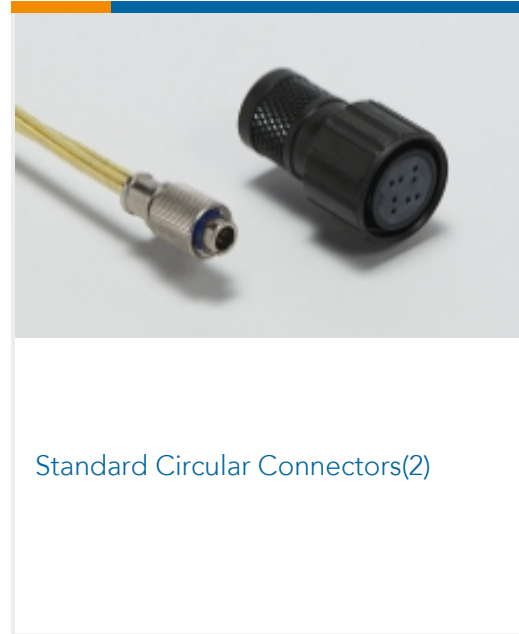
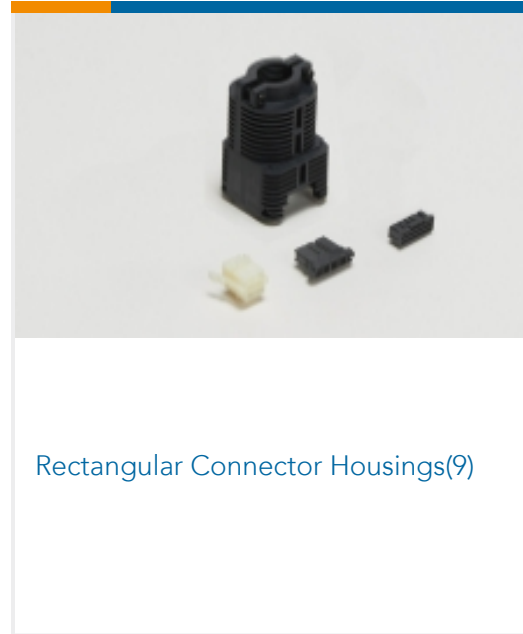
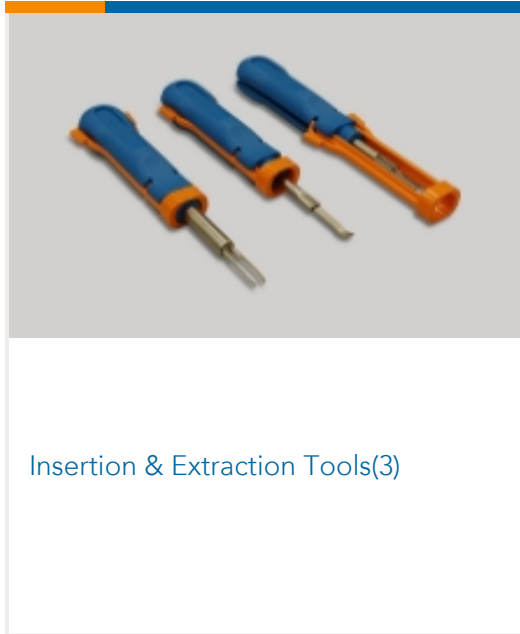
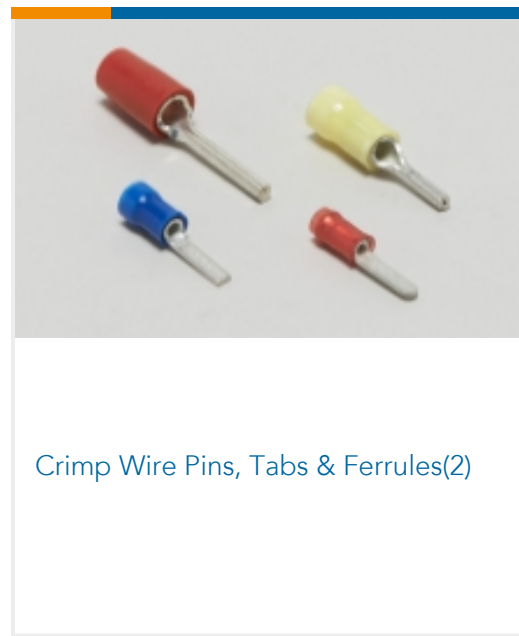
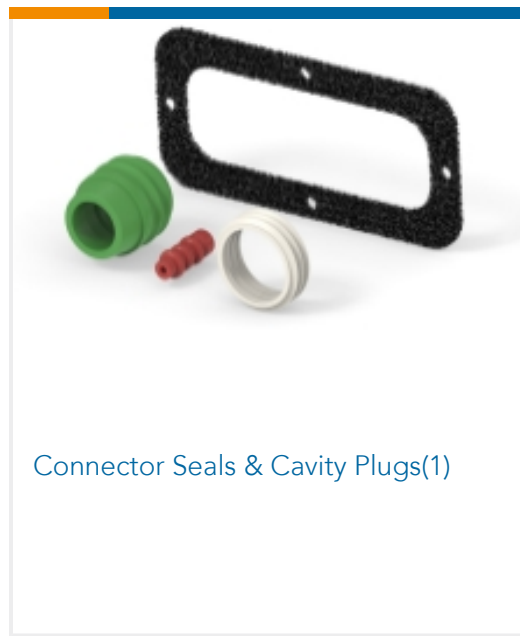
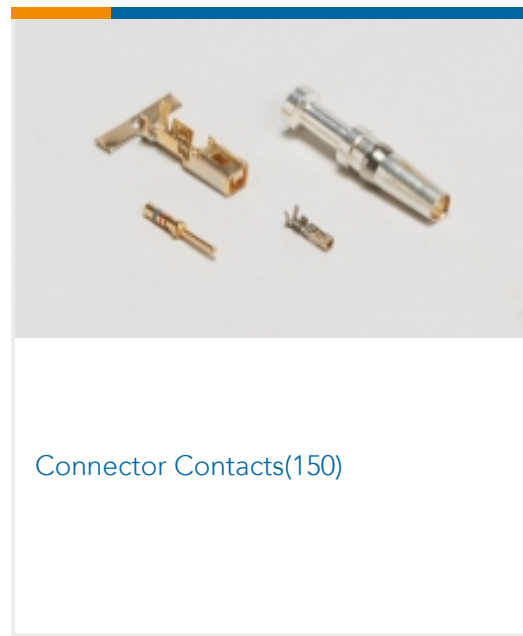

## Customers Also Bought

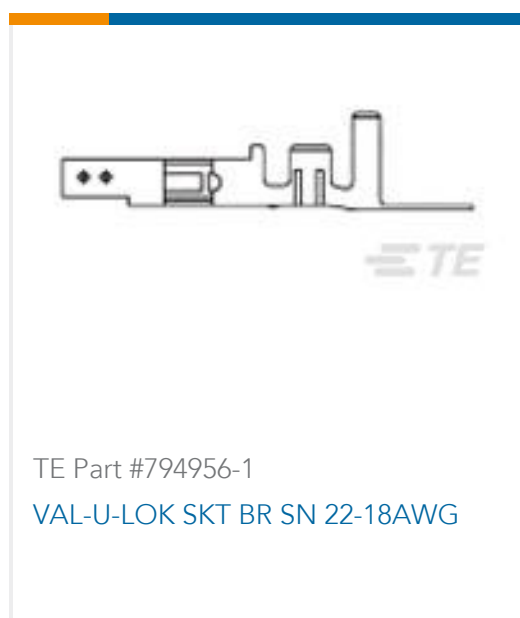
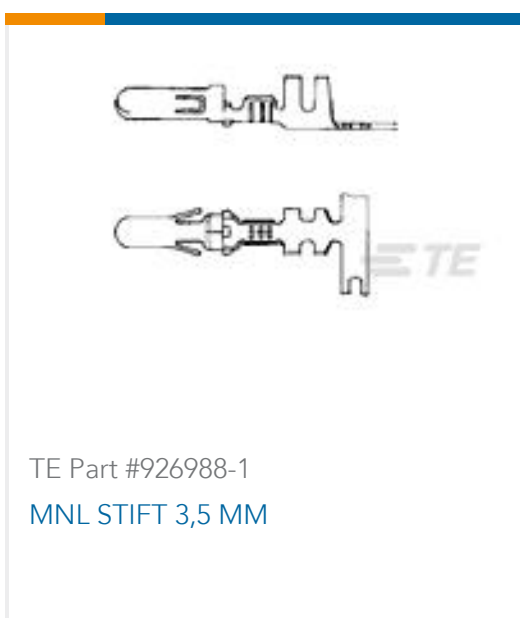
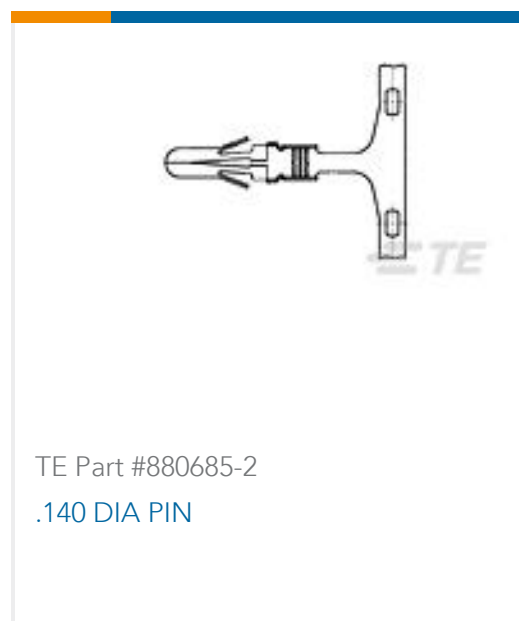



## Documents

### Product Drawings

#### MNL BUCHSE 3,5 MM

English

### CAD Files

#### Customer View Model

[ENG\\_CVM\\_926986-2\\_A.3d\\_igs.zip](#)

English

#### Customer View Model

[ENG\\_CVM\\_926986-2\\_A.3d\\_stp.zip](#)

English

#### Customer View Model

[ENG\\_CVM\\_926986-2\\_A.2d\\_dxf.zip](#)

English

### 3D PDF

English

By downloading the CAD file I accept and agree to the [Terms and Conditions](#) of use.

### Product Specifications

#### Product Specification

English