

926319-1 ✓ ACTIVE

[Positive Lock](#) | [Positive Lock 250](#)

TE Internal #: 926319-1

Crimp Terminal Housings, Receptacle, Receptacle, 2 Position, Flag,  
UL 94V-0, Black, Polyamide, Contact Mating Retention, Positive  
Lock 250

[View on TE.com >](#)



Terminals & Splices > Terminal Housings, Insulation Sleeves & Blocks > Crimp Terminal Housings

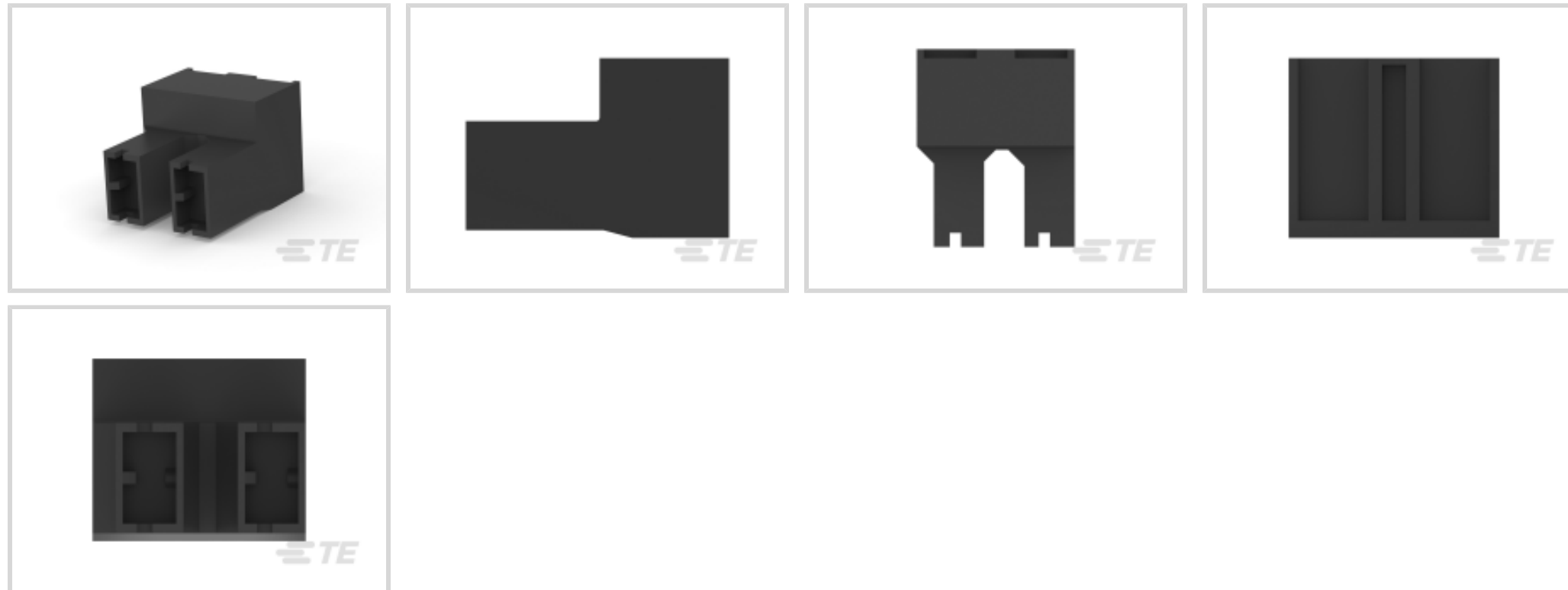

Terminal Type: **Receptacle**

Connector & Housing Type: **Receptacle**

Number of Positions: **2**

Terminal Orientation: **Flag**

UL Flammability Rating: **UL 94V-0**

## Features

### Product Type Features

Sealable	No
Connector System	Wire-to-Board, Wire-to-Wire
Connector & Contact Terminates To	Wire & Cable
Connector & Housing Type	Receptacle

### Configuration Features

Number of Positions	2
---------------------	---

### Body Features

Primary Product Color	Black
-----------------------	-------

### Contact Features

Terminal Type	Receptacle
Terminal Orientation	Flag
Contact Mating Retention	With

### Mechanical Attachment



Mating Alignment Type	Polarization
Mating Alignment	With
Connector Mounting Type	Cable Mount (Free-Hanging)

### Housing Features

Housing Material	Polyamide
Centerline (Pitch)	10 mm[.393 in]

### Usage Conditions

Operating Temperature Range	-40 – 105 °C[-40 – 221 °F]
-----------------------------	----------------------------

### Industry Standards

UL Flammability Rating	UL 94V-0
------------------------	----------

### Packaging Features

Packaging Quantity	2000
Packaging Method	Carton

## Product Compliance

[For compliance documentation, visit the product page on TE.com>](#)

EU RoHS Directive 2011/65/EU	Compliant
EU ELV Directive 2000/53/EC	Compliant
China RoHS 2 Directive MIIT Order No 32, 2016	No Restricted Materials Above Threshold
EU REACH Regulation (EC) No. 1907/2006	Current ECHA Candidate List: JUNE 2024 (241) Candidate List Declared Against: JAN 2024 (240) Does not contain REACH SVHC
Halogen Content	Low Halogen - Br, Cl, F, I < 900 ppm per homogenous material. Also BFR/CFR/PVC Free
Solder Process Capability	Not applicable for solder process capability

#### Product Compliance Disclaimer

This information is provided based on reasonable inquiry of our suppliers and represents our current actual knowledge based on the information they provided. This information is subject to change. The part numbers that TE has identified as EU RoHS compliant have a maximum concentration of 0.1% by weight in homogenous materials for lead, hexavalent chromium, mercury, PBB, PBDE, DBP, BBP, DEHP, DIBP, and 0.01% for cadmium, or qualify for an exemption to these limits as defined in the Annexes of Directive 2011/65/EU (RoHS2). Finished electrical and electronic equipment products will be CE marked as required by Directive 2011/65/EU. Components may not be CE marked. Additionally, the part numbers that TE has identified as EU ELV compliant have a maximum concentration of 0.1% by weight in homogenous materials for lead, hexavalent chromium, and mercury, and 0.01% for cadmium, or qualify for an exemption to these limits as defined in the Annexes of Directive 2000/53/EC (ELV). Regarding the REACH Regulation, the information TE provides on SVHC in articles for this part number is based on the latest European Chemicals Agency (ECHA) 'Guidance on

requirements for substances in articles' posted at this URL: <https://echa.europa.eu/guidance-documents/guidance-on-reach>

## Compatible Parts



TE Part # 1743206-2  
POSITIVE LOCK 250 RECEPTACLE



TE Part # 927389-2  
POSITIVE LOCK 3P HOUSING PA 6.6 WHITE



TE Part # 927076-1  
PL HOUSING 0.6 PA 6.6 + PE-GF13 BLACK



TE Part # 926521-2  
PL 250 REC HSG 2P NYLON BLACK



TE Part # 926522-1  
PL 250 REC HSG 2P NYLON BLACK



TE Part # 1-926522-1  
PL 250 REC HSG 2P NYLON BLACK



TE Part # 185010-2  
HEADLIGHT HOUSING HOUSING



TE Part # 179720-1  
187 HSG. PL MKII REC. 10mm 2P NAT



TE Part # 172864-2  
250 HSG. REC. 6mm 2P BLACK



TE Part # 179720-2  
PL 187 (4.8 MM) HOUSING RECEPTACLE



TE Part # 927389-1  
PL 3P HOUSING PA66 BLACK



TE Part # 927422-1  
POSITIVE LOCK 3P HOUSING PA6.6 BLACK



TE Part # 1-1743206-2  
250 FLAG P-LOCK HSG 2P 12.0 BLK GWT



TE Part # 100100-1  
2 POS POSITIVE LOCK (PL) HOUSING

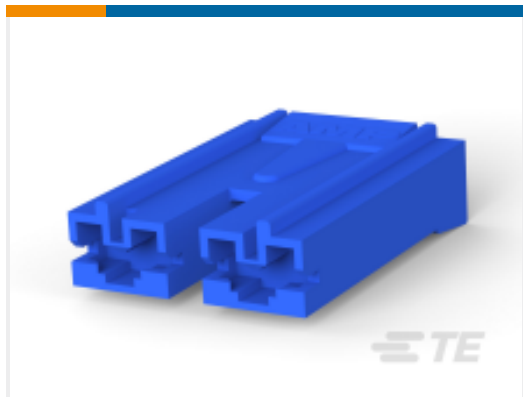

TE Part # 179720-6  
PL 187 (4.8 MM) HOUSING RECEPTACLE

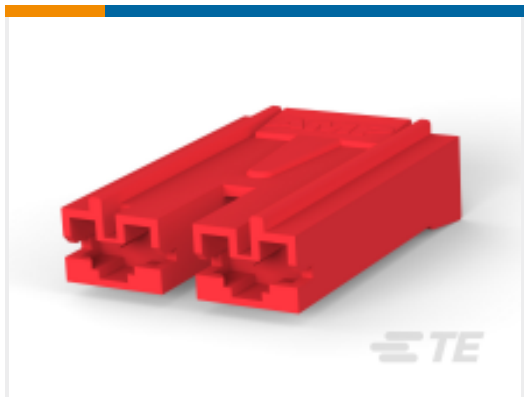

TE Part # 179720-7  
PL 187 (4.8 MM) HOUSING RECEPTACLE



## Also in the Series | Positive Lock 250

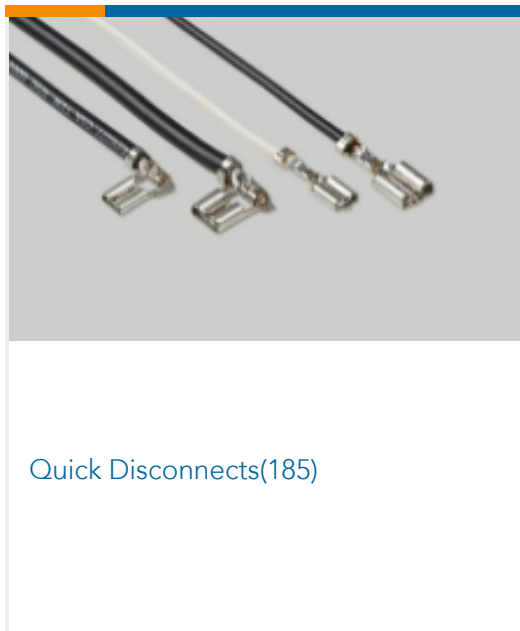
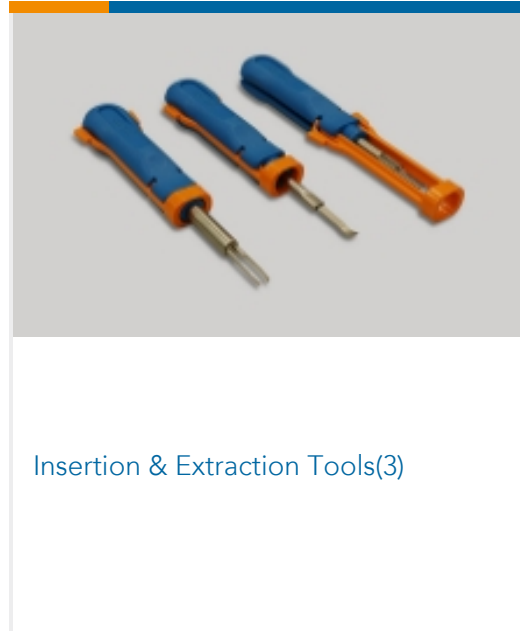
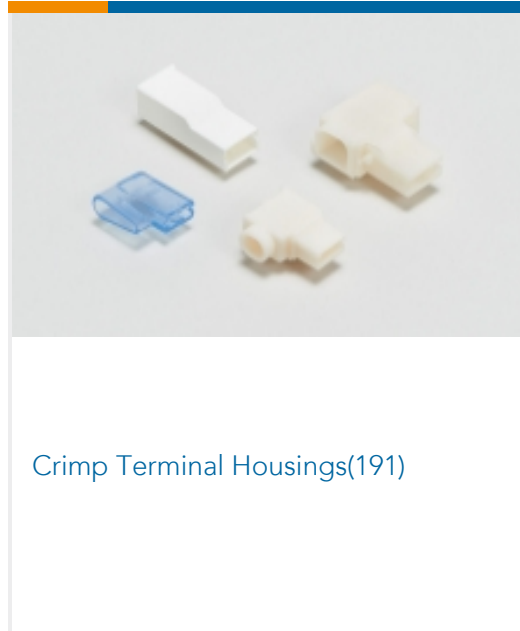
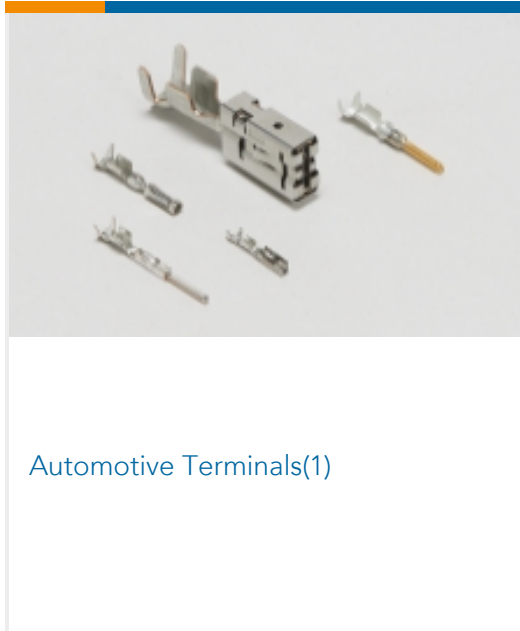

## Customers Also Bought

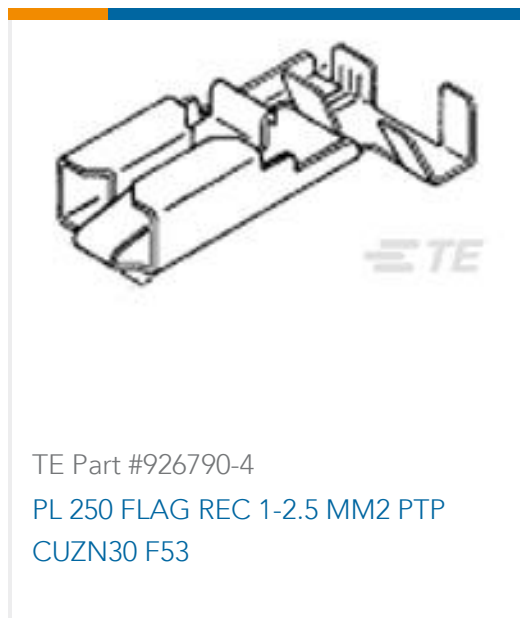



## Documents

### Product Drawings

[PL 250 REC HSG 2P NYLON BLACK](#)

English

### CAD Files

[3D PDF](#)

3D

Customer View Model

[ENG\\_CVM\\_CVM\\_926319-1\\_E.2d\\_dxf.zip](#)

English

Customer View Model

[ENG\\_CVM\\_CVM\\_926319-1\\_E.3d\\_igs.zip](#)

English

Customer View Model

[ENG\\_CVM\\_CVM\\_926319-1\\_E.3d\\_stp.zip](#)

English

By downloading the CAD file I accept and agree to the [Terms and Conditions](#) of use.

### Product Specifications

[Application Specification](#)

English