

**PLEASE CHECK WWW.MOLEX.COM FOR LATEST PART INFORMATION**

**Part Number:** [90170-0034](#)  
**Status:** **Active**  
**Overview:** [QF-50™](#)  
**Description:** 2.54mm Pitch QF-50™, Strain Relief, DIN 41651, Standard Low Profile, 34 Circuits

**Documents:**

[3D Model](#) [Packaging Specification PK-90170-001 \(PDF\)](#)  
[Drawing \(PDF\)](#) [RoHS Certificate of Compliance \(PDF\)](#)  
[Product Specification PS-99020-0015 \(PDF\)](#)

**General**

Product Family	Ribbon Cable / Wire Trap Connectors
Series	<a href="#">90170</a>
Component Type	Strain Relief
Glow-Wire Compliant	No
Overview	<a href="#">QF-50™</a>
Product Name	QF-50™
UPC	800753533226

**Physical**

Circuits (Loaded)	N/A
Circuits (maximum)	34
Color - Resin	Black
Entry Angle	N/A
Lock to Mating Part	Yes
Material - Plating Mating	N/A
Material - Resin	Polyester
Net Weight	0.838/g
Number of Rows	2
PCB Locator	No
PCB Retention	None
Packaging Type	Bag
Pitch - Mating Interface	1.27mm
Polarized to Mating Part	No
Stackable	No
Temperature Range - Operating	-25°C to +85°C
Wire Insulation Diameter	N/A
Wire Size AWG	N/A
Wire/Cable Type	Ribbon Cable

**Electrical**

Current - Maximum per Contact	1A
Voltage - Maximum	250V AC/DC

**Material Info**

**Reference - Drawing Numbers**

Packaging Specification	PK-90170-001
Product Specification	PS-99020-0015
Sales Drawing	SD-90170

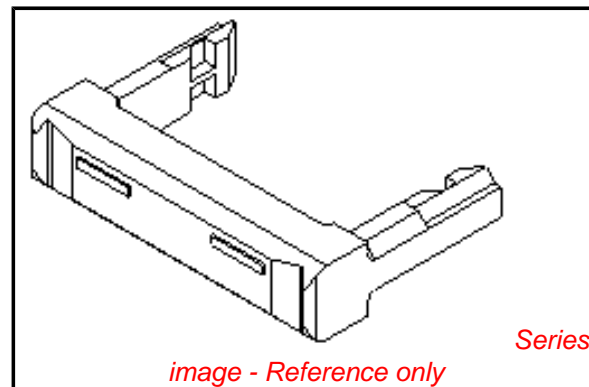

*image - Reference only*

**EU RoHS**

**ELV and RoHS  
Compliant**  
**REACH SVHC  
Contains SVHC: No**  
**Low-Halogen Status  
Not Low-Halogen**

**China RoHS**



**Need more information on product  
environmental compliance?**

Email [productcompliance@molex.com](mailto:productcompliance@molex.com)  
For a multiple part number RoHS Certificate of Compliance, [click here](#)

Please visit the [Contact Us](#) section for any non-product compliance questions.

**Search Parts in this Series**

90170Series

**Use With**

5320 , 90635