



### Main

Range of product	Harmony 9001K Harmony 9001SK
Product or component type	Empty enclosure
Device short name	9001K
Number of cut-out	2 cut-outs
Cable entry	1 entry tapped for 3/4" knockout

### Complementary

Product destination	For Ø 30 mm control and signalling units
Material	Stainless steel
Product weight	1.37 kg

### Environment

Protective treatment	TH
Ambient air temperature for storage	-40...70 °C
Ambient air temperature for operation	-25...70 °C
Overvoltage category	II conforming to IEC 61140
NEMA degree of protection	NEMA 1 NEMA 12 NEMA 3 NEMA 4 NEMA 4X

### Offer Sustainability

Sustainable offer status	Green Premium product
RoHS (date code: YYWW)	Compliant - since 1230 - Schneider Electric declaration of conformity <a href="#">Schneider Electric declaration of conformity</a>
REACH	Reference not containing SVHC above the threshold

Reference not containing SVHC above the threshold

---

Product environmental profile	Available
Product end of life instructions	Need no specific recycling operations

---

Contractual warranty

---

Warranty period	18 months
-----------------	-----------

---

Dimensions

Below drawing shows a 3-hole enclosure. Refer to the product characteristics to get the number of holes

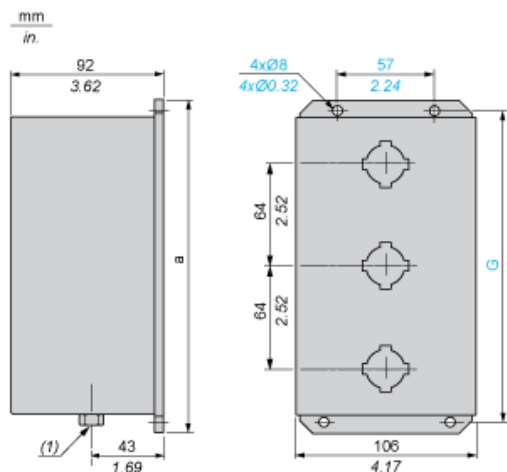

(1) Knockout conduit thread: 3/4".

a		G	
mm	in.	mm	in.
197	7.75	181	7.12