



Main

Range of product	Harmony 9001K
Product or component type	Push-button
Device short name	9001K
Type of operator	Spring return
Operator profile	Red mushroom Ø 35 mm, unmarked

Complementary

Bezel material	Metal
Mounting diameter	30 mm
CAD overall width	46 mm
CAD overall height	45 mm
CAD overall depth	70 mm
Terminals description ISO n°1	(13-14-11-12)OF
Net weight	0.126 kg
Operating position	Any position
Shape of signaling unit head	Round
Head material	Plastic
Operator additional information	Screw-on plastic with set screw
Contacts type and composition	1 C/O
Positive opening	Without
Mechanical durability	5000000 cycles
Connections - terminals	Screw clamp terminals, 1 x 0.22...2 x 1.5 mm ² conforming to EN/IEC 60947-1
Tightening torque	0.8 N.m conforming to EN/IEC 60947-1
Shape of screw head	Cross slotted
Contacts material	Silver alloy contacts
Short-circuit protection	10 A cartridge fuse conforming to EN/IEC 60947-5-1
[I _{th}] conventional free air thermal current	10 A
[U _i] rated insulation voltage	250 V (pollution degree 3) conforming to EN/IEC 60947-1
[U _{imp}] rated impulse withstand voltage	2.5 kV conforming to EN/IEC 60947-1
[I _e] rated operational current	3 A at 240 V, AC-15, A600-Q600 conforming to NEMA 0.55 A at 125 V, DC-13, A600-Q600 conforming to NEMA
[I _{cm}] rated short-circuit making capacity	12 KA at 600 V AC-15, 7200 VA 15 KA at 480 V AC-15, 7200 VA 30 KA at 240 V AC-15, 7200 VA 60 KA at 120 V AC-15, 7200 VA 0.1 KA at 600 V DC-13 0.27 KA at 250 V DC-13 0.55 kA at 125 V DC-13
Rated breaking capacity	3 KA at 240 V AC-15, 720 VA 6 KA at 120 V AC-15, 720 VA 1.2 KA at 600 V AC-15, 720 VA 1.5 KA at 480 V AC-15, 720 VA 0.1 KA at 600 V DC-13 0.27 KA at 250 V DC-13 0.55 kA at 125 V DC-13
Device presentation	Complete product

Cap/operator or lens colour	Red
Operator profile	Mushroom Ø 35 mm
Type of operator	Spring return
Size	30 mm





Environment

Protective treatment	TC
Ambient air temperature for storage	-40...70 °C
Ambient air temperature for operation	-25...70 °C
Overvoltage category	Class II conforming to IEC 61140
IP degree of protection	IP66 conforming to IEC 60529
NEMA degree of protection	NEMA 1 NEMA 12 NEMA 13 NEMA 2 NEMA 3 NEMA 3R NEMA 4 NEMA 6
Standards	EN/IEC 60947-5-1 EN/IEC 60947-1 EN/IEC 60947-5-4 JIS C 4520 JIS C 852 UL 508 CSA C22.2 No 14
Product certifications	NEMA UL 508
Vibration resistance	7 gn (f= 2...500 Hz) conforming to IEC 60068-2-6
Shock resistance	50 gn conforming to IEC 60068-2-27

Packing Units

Unit Type of Package 1	PCE
Number of Units in Package 1	1
Package 1 Height	5.5 cm
Package 1 Width	9.3 cm
Package 1 Length	4.6 cm
Package 1 Weight	154.0 g
Unit Type of Package 2	S01
Number of Units in Package 2	24
Package 2 Height	15.0 cm
Package 2 Width	15.0 cm
Package 2 Length	40.0 cm
Package 2 Weight	3.796 kg

Offer Sustainability

Sustainable offer status	Green Premium product
REACH Regulation	 REACH Declaration
EU RoHS Directive	Pro-active compliance (Product out of EU RoHS legal scope)  EU RoHS Declaration
Mercury free	Yes
China RoHS Regulation	 China RoHS Declaration
RoHS exemption information	 Yes
Environmental Disclosure	 Product Environmental Profile
WEEE	The product must be disposed on European Union markets following specific waste collection and never end up in rubbish bins

Contractual warranty

Warranty	18 months
----------	-----------

Dimensions

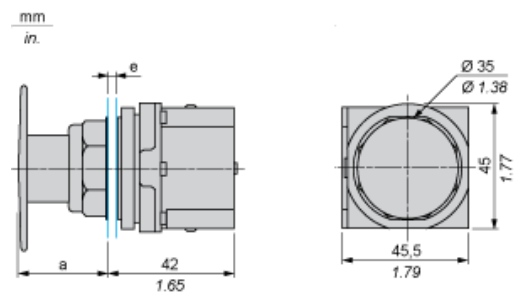

- e panel thickness: 1 to 6 mm / 0.04 to 0.24 in.
- a 28 mm / 1.10 in.

Contact Block Mounting Position

Top and Rear views

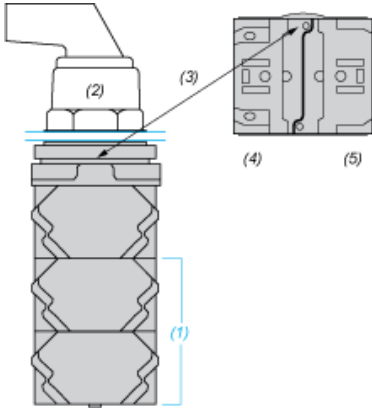

- (1) It is possible to mount up to 3 levels of contacts blocks (maximum of 6 contacts blocks)
- (2) Operator
- (3) Locating notch
- (4) Side 1
- (5) Side 2

Panel Cut-Out

Clearance

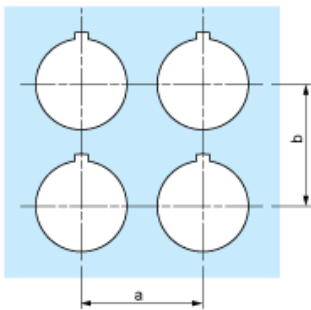

Legend plate	a min.		b min.	
	mm	in.	mm	in.
9001KN2••	57.2	2.25	44.5	1.75
9001KN3••	57.2	2.25	50.8	2.00

Individual Cut-outs Details

2 alternatives

