

Data Sheet | Item Number: 890-112

Plug; with strain relief housing; 2-pole; 1,50 mm²; black

<https://www.wago.com/890-112>



Color: ■ black

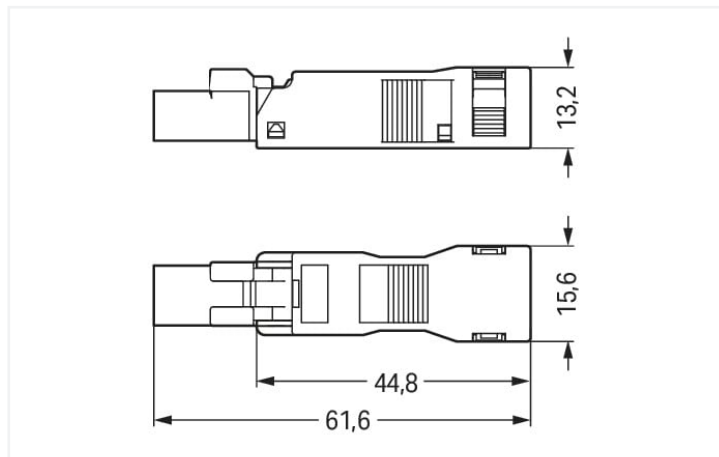

Dimensions in mm

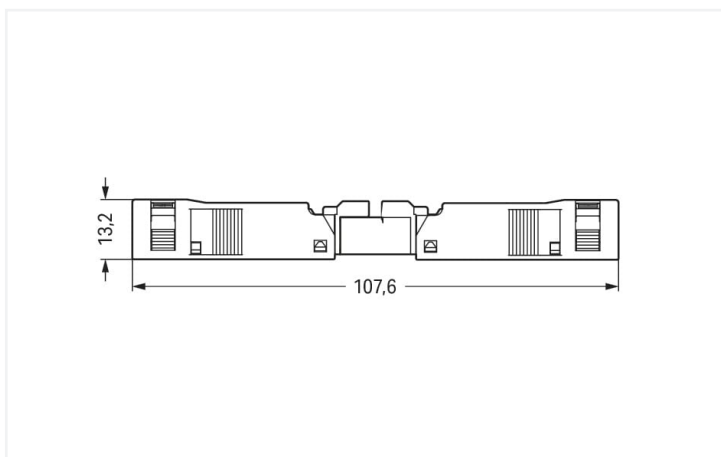

Dimensions in mm

Overall length when mated

Male connector/plug *WINSTA*® MINI rated current 16 A

For power and signal transmission: The *WINSTA*® MINI male connector/plug with protection type IP40. WAGO pluggable installation connectors are used when specifications repeat or are planned on a specific grid, for example for installing grid lighting or flush-mount lighting. The coding options reduce installation errors, allowing fast, maintenance-free wiring of all components. The pluggable installation connector is protected against ingress by solid granular objects with a diameter below 1 mm in accordance with protection type IP40. Standard mains applications for almost any domain of use can be implemented with *WINSTA*® MINI pluggable installation connectors with A coding. *WINSTA*® MINI follows the trend towards miniaturisation. Our smallest pluggable connection system is primarily suited for lights, for example, since due to LED technology, these offer less and less space for the connection technology. A range up to 32 mm can be used for the strip length.

Lower costs through fast commissioning and elimination of service expenses – solutions from *WINSTA*® MINI

WINSTA® is the pluggable connection system that is perfectly tailored to the strict requirements of electrical installation. It ensures fast, secure and, above all, error-free installation of components and cables. Now you can also lower installation expenses without compromising safety and quality: with marking eliminates the need for servicing and prevents unnecessary downtime.

- protection against mismatching eliminates errors
- compact design for conductors with a cross-section up to 1.5 mm²
- for any mains application
- ready for immediate use
- quick replacement of defective units during ongoing operation

This item includes:



Item No.: 890-212

1

Plug; 2-pole; Cod. A; 1,50 mm²; black

Item No.: 890-502

1

Strain relief housing; 2-pole; with locking clip; for 1 cable; 3.8 ... 8.2 mm; 30 mm; black

Electrical data

Ratings per	IEC/EN 60664-1		
Overvoltage category	III	III	II
Pollution degree	3	2	2
Nominal voltage	250 V	-	-
Rated surge voltage	4 kV	-	-
Rated current	16 A	-	-

Approvals per	UL 1977
Rated voltage	600 V
Rated current	14 A

General information

Note on contact resistance	approx. 1 mΩ of contact resistance approx. 0.25 mΩ contact transition plug/ socket
----------------------------	--

Connection data

Clamping units	2
Total number of potentials	2

Connection 1	
Connection technology	Push-in CAGE CLAMP®
Actuation type	Operating tool Push-in
Nominal cross-section	1.5 mm ² / 16 AWG
Solid conductor	0.25 ... 1.5 mm ² / 22 ... 16 AWG
Solid conductor; push-in termination	0.75 ... 1.5 mm ² / 20 ... 16 AWG
Stranded conductor	0.25 ... 1 mm ² / 22 ... 18 AWG
Fine-stranded conductor	0.25 ... 1.5 mm ² / 22 ... 16 AWG
Fine-stranded conductor; with insulated ferrule	0.25 ... 0.75 mm ² / 22 ... 20 AWG
Fine-stranded conductor; with uninsulated ferrule	0.25 ... 0.75 mm ² / 22 ... 20 AWG
Fine-stranded conductor; with ferrule; push-in termination	0.75 mm ² / 20 AWG
Strip length	9 mm / 0.35 inches
Pole number	2
Connectable sheathed cable diameter	3.8 ... 8.2 mm
Conductor entry direction to mating direction	0°
Strip length (outer insulation)	32 mm

Physical data

Pin spacing	4.4 mm / 0.173 inches
Width	15.6 mm / 0.614 inches
Height	13.2 mm / 0.52 inches
Depth	61.6 mm / 2.425 inches

Mechanical data

Use	General mains applications
Coding	A
Variable coding	No
Marking	N L
Potential marking	N L
Mating force of a plug-in connection	approx. 20 ... 70 N (depending on pole number)
Retention force of a plug-in connection	Locked: > 80 N
Unmating force of a plug-in connection	Unlocked: approx. 20 ... 70 N (depending on pole number)
Number of mating cycles	200, without resistive load
Protection type	IP40

Plug-in connection

Contact type (pluggable connector)	Male connector/plug
Connector (connection type)	for conductor
Mismating protection	Yes
Note on mismating protection	All WINSTA® components are 100% protected against mismating when: a.) plugging different numbers of poles b.) plugging while rotated 180 c.) plugging while laterally staggered d.) plugging one pole
Locking lever	Can be retrofitted
Locking of plug-in connection	Locking lever
Note on locking system	All connectors for mounted installations (snap-in versions for lighting fixtures or devices, all types of PCB and distribution connectors) are factory-equipped with locking levers to ensure plugs and sockets are securely locked. Additional locking levers are only required for flying leads (plug/socket).
Strain relief	Strain relief housing

Material data

Note (material data)	Information on material specifications can be found here
Color	black
Cover color	gray
Material group	I
Insulation material (main housing)	Polyamide (PA66)
Flammability class per UL94	V0
Clamping spring material	Chrome-nickel spring steel (CrNi)
Contact material	Copper or copper alloy; surface-treated
Contact Plating	Tin
Fire load	0.194 MJ
Connector color	black
Strain relief color	black
Weight	5.5 g

Environmental requirements

Processing temperature	-5 ... +40 °C
Continuous operating temperature	-35 ... +85 °C
Note on continuous operating temperature	Insulating parts for temperatures ≤ 105 °C

Commercial data

Product Group	20 (Winsta)
eCl@ss 10.0	27-44-06-05
eCl@ss 9.0	27-44-06-05
ETIM 9.0	EC002560
ETIM 8.0	EC002560
PU (SPU)	50 pcs
Packaging type	Box
Country of origin	DE
GTIN	4045454232894
Customs tariff number	85366990990

Environmental Product Compliance

RoHS Compliance Status	Compliant, No Exemption
------------------------	-------------------------

Approvals / Certificates

General approvals



Approval	Standard	Certificate Name
CCA DEKRA Certification B.V.	EN 61535	71-123231
CCA DEKRA Certification B.V.	IEC 61535	NL-85020
cURus Underwriters Laboratories Inc.	UL 1977	E45171

Declarations of conformity and manufacturer's declarations

Approval	Standard	Certificate Name
EU-Declaration of Confor- mity WAGO GmbH & Co. KG	-	-
UK-Declaration of Confor- mity WAGO GmbH & Co. KG	-	-

Approvals for marine applications



Approval	Standard	Certificate Name
ABS American Bureau of Ship- ping	Steel Vessel Rules	19-HG1869855-PDA
DNV GL Det Norske Veritas, Ger- manischer Lloyd	-	TAE00001Z6
LR Lloyds Register	EN 61535	08/20047 (E2)

Downloads

Environmental Product Compliance

Compliance Search			
Environmental Product Compliance 890-112			↓

Documentation

Bid Text			
890-112	19.02.2019	xml 3.03 KB	↓
890-112	08.06.2015	doc 23.00 KB	↓

CAD/CAE-Data

CAD data	
2D/3D Models 890-112	↓

CAE data	
EPLAN Data Portal 890-112	↓
WSCAD Universe 890-112	↓
ZUKEN Portal 890-112	↓

1 Compatible Products

1.1 System counterpart

1.1.1 Cable assembly



Item No.: 891-8992/105-101
pre-assembled connecting cable; Eca; Socket/open-ended; 2-pole; Cod. A; H05VV-F 2 x 1.0 mm²; 1 m; 1,00 mm²; black

Item No.: 891-8992/005-101
pre-assembled interconnecting cable; Eca; Socket/plug; 2-pole; Cod. A; H05VV-F 2 x 1.0 mm²; 1 m; 1,00 mm²; black

1.1.2 Distribution connector



Item No.: 890-1634
h-distribution connector; 2-pole; Cod. A; 1 input; 2 outputs; outputs on one side; 2 locking levers; black

Item No.: 890-1636
h-distribution connector; 2-pole; Cod. A; 1 input; 2 outputs; outputs on one side; 3 locking levers; for flying leads; black

Item No.: 890-1606
T-distribution connector; 2-pole; Cod. A; 1 input; 2 outputs; 2 locking levers; black

Item No.: 890-1615
T-distribution connector; 2-pole; Cod. A; 1 input; 2 outputs; 3 locking levers; for flying leads; black

1.1.3 Female connector/socket



Item No.: 890-702

Snap-in socket; 2-pole; Cod. A; 1,50 mm²; black



Item No.: 890-802/011-000

Socket for PCBs; angled; 2-pole; Cod. A; black



Item No.: 890-802

Socket for PCBs; straight; 2-pole; Cod. A; black



Item No.: 890-202

Socket; 2-pole; Cod. A; 1,50 mm²; black



Item No.: 890-102

Socket; with strain relief housing; 2-pole; Cod. A; 1,50 mm²; black



Item No.: 890-202/342-000

Socket; with strain relief housing; 2-pole; Cod. A; 1,50 mm²; black

1.2 Required Accessories

1.2.1 Locking system

1.2.1.1 Locking system



Item No.: 890-111

Locking lever; for flying leads; for tool operation; black



Item No.: 890-131

Locking lever; for flying leads; for tool operation; white



Item No.: 890-101

Locking lever; for manual operation; black



Item No.: 890-121

Locking lever; for manual operation; white

1.3 Optional Accessories

1.3.1 Cover

1.3.1.1 Cover



Item No.: 897-2001

Protective cap; Type1; for sockets and plugs; PVC; red

1.3.2 Installation

1.3.2.1 Mounting accessories



Item No.: 890-310

Mounting carrier; 2- to 5-pole; for flying leads; black



Item No.: 890-311

Mounting carrier; 2- to 5-pole; for flying leads; white

1.3.3 Tool

1.3.3.1 Operating tool



Item No.: 890-382

Operating tool; 2-way; green



Item No.: 210-719

Operating tool; Blade: 2.5 x 0.4 mm; with a partially insulated shaft

Installation Notes

Conductor termination

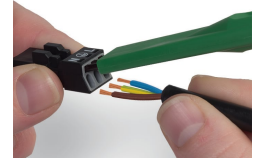
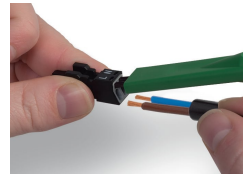
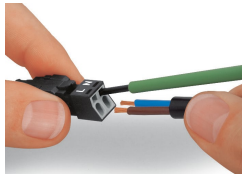

1. Strip length, outer insulation = 30 mm (2-pole), 37 mm (3-pole), 45 mm (4- and 5-pole)
2. Strip length = 9 mm
3. Extended ground conductor = 8 mm

To terminate fine-stranded conductors, open the clamping unit via screwdriver – 2.5 mm blade width – and insert a stripped conductor until it hits the backstop. Terminate solid conductors by simply pushing them in.

To terminate fine-stranded conductors, open clamping units via operating tool (890-382) and insert stripped conductors until they hit backstop. Terminate solid conductors by simply pushing them in.

To terminate fine-stranded conductors, open clamping units via operating tool (890-383) and insert stripped conductors until they hit backstop. Terminate solid conductors by simply pushing them in.

Installation

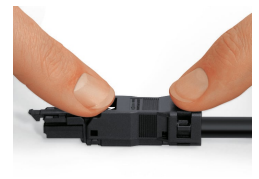
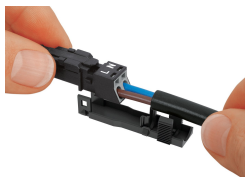

Latch the wired connector into the base of the strain relief housing.

Push down strain relief clamp by hand.

Push down strain relief clamp with 2.5 mm screwdriver alternately on both sides.

Latch the top of the strain relief housing.



The printed marking of the connector is clearly visible in the openings of the strain relief housing.