

MCZ R 36VDC 1CO AU TRAK

Weidmüller Interface GmbH & Co. KG

Klingenbergstraße 26

D-32758 Detmold

Germany

www.weidmueller.com

Product image

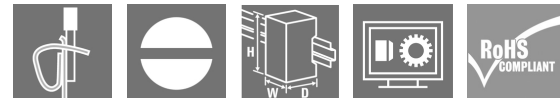

Similar to illustration

High reliability in a terminal block format

MCZ SERIES relay modules are among the smallest on the market. Thanks to the small width of just 6.1 mm, a lot of space can be saved in the panel. All products in the series have three cross-connection terminals and are distinguished by simple wiring with plug-in cross-connections. The tension clamp connection system, proven a million times over, and the integrated reverse polarity protection ensure a high level of safety during installation and operation. Precisely fitting accessories from cross-connectors to markers and end plates make the MCZ SERIES versatile and convenient to use.

- Tension clamp connection
- Integrated cross-connection in input/output.
- Clampable conductor cross-section is 0.5 to 1.5 mm²
- Variants of the MCZ TRAK type are particularly suitable for the transport sector and tested according to DIN EN 50155

General ordering data

Version	MCZ-SERIES TRAK, Relay module, Number of contacts: 1, CO contact AgSnO gold-plated, Rated control voltage: 36 V DC +25 % / -30 %, Continuous current: 6 A, Tension-clamp connection, Test button available: No
Order No.	8790510000
Type	MCZ R 36VDC 1CO AU TRAK
GTIN (EAN)	4032248479528
Qty.	10 pc(s).

MCZ R 36VDC 1CO AU TRAK

Weidmüller Interface GmbH & Co. KG

Klingenbergstraße 26

D-32758 Detmold

Germany

www.weidmueller.com

Technical data

Dimensions and weights

Depth	63.2 mm	Depth (inches)	2.488 inch
Height	91 mm	Height (inches)	3.583 inch
Width	6.1 mm	Width (inches)	0.24 inch
Net weight	27 g		

Temperatures

Storage temperature	-40 °C...85 °C	Operating temperature	-25 °C...70 °C
Humidity	95 % for 30 days, minimal condensation to EN 50155	Note: room temperature (service)	+85 °C for 10 minutes

Control side

Rated control voltage	36 V DC +25 % / -30 %	Rated current DC	8...12 mA
Power rating	200...540 mW	Status indicator	Green LED
Protective circuit	Free-wheeling diode, Varistor, Reverse polarity protection		

Load side

Rated switching voltage	250 V AC	Continuous current	6 A
Max. switching frequency at rated load	0.1 Hz	Max. switching voltage, AC	250 V
Max. switching voltage, DC	250 V	Inrush current	6 A
AC switching capacity (resistive), max.	1500 VA	DC switching capacity (resistive), max.	120 W @ 24 V
Switch-on delay	<6 ms	Switch-off delay	<70 ms
Contact type	1 CO contact (AgSnO gold-plated)	Mechanical service life	10 x 10 ⁶ switching cycles
Min. switching power	1 mA @ 1 V		

General data

Version	for railway applications		
Rail	TS 35		
Test button available	No		
Mechanical switch position indicator	No		
Open sides	right		
Colour	beige		
UL94 flammability rating component	Component	Housing	
	UL94 flammability rating	V-0	

Insulation coordination

Rated voltage	300 V	Pollution severity	2
Surge voltage category	III	Clearance and creepage distances for control side - load side	≥ 5.5 mm
Dielectric strength for control side - load side	4 kV _{eff} / 1 s	Dielectric strength to mounting rail	4 kV _{eff} / 1 Min.
Impulse withstand voltage	4 kV (1.2/50 µs)	Protection degree	IP20

MCZ R 36VDC 1CO AU TRAK

Weidmüller Interface GmbH & Co. KG

Klingenbergstraße 26

D-32758 Detmold

Germany

www.weidmueller.com

Technical data

Connection data

Wire connection method	Tension-clamp connection	Stripping length, rated connection	8 mm
Clamping range, rated connection	1.5 mm ²	Clamping range, min.	0.5 mm ²
Clamping range, max.	1.5 mm ²	Wire connection cross section AWG, min.	AWG 26
Wire connection cross section AWG, max.	AWG 16	Wire cross-section, solid, min.	0.5 mm ²
Wire cross-section, solid, max.	1.5 mm ²	Wire cross-section, solid, min. (AWG)	AWG 26
Wire cross-section, solid, max. (AWG)	AWG 16	Wire connection cross section, finely stranded, min.	0.5 mm ²
Wire connection cross section, finely stranded, max.	1.5 mm ²	Wire cross-section, finely stranded, min. (AWG)	AWG 26
Wire cross-section, finely stranded, max. (AWG)	AWG 16	Wire connection cross-section, finely stranded with wire-end ferrules DIN 46228/4, min.	0.5 mm ²
Wire connection cross-section, finely stranded with wire-end ferrules DIN 46228/4, max.	1.5 mm ²	Conductor cross-section, flexible, AEH (DIN 46228-1), min.	0.5 mm ²
Conductor cross-section, flexible, AEH (DIN 46228-1), max.	1.5 mm ²	Blade size	0.6 x 3.5 mm

Classifications

ETIM 6.0	EC001437	ETIM 7.0	EC001437
ETIM 8.0	EC001437	ETIM 9.0	EC001437
ECLASS 9.0	27-37-16-01	ECLASS 9.1	27-37-16-01
ECLASS 10.0	27-37-16-01	ECLASS 11.0	27-37-16-01
ECLASS 12.0	27-37-16-01	ECLASS 13.0	27-37-16-01

Environmental Product Compliance

REACH SVHC	Lead 7439-92-1
SCIP	35d83707-6a3b-45b5-b9f8-6ba8184c863e

Approvals

Approvals



ROHS	Conform
------	---------

Downloads

Approval/Certificate/Document of Conformity	EU Konformitätserklärung / EU Declaration of Conformity
Engineering Data	CAD data – STEP
Engineering Data	Zuken E3.S
User Documentation	Device description – Beipackzettel / Package Insert – multilingual
Catalogues	Catalogues in PDF-format
Brochures	

MCZ R 36VDC 1CO AU TRAK

Weidmüller Interface GmbH & Co. KG
 Klingenbergstraße 26
 D-32758 Detmold
 Germany

www.weidmueller.com

Drawings

Product image

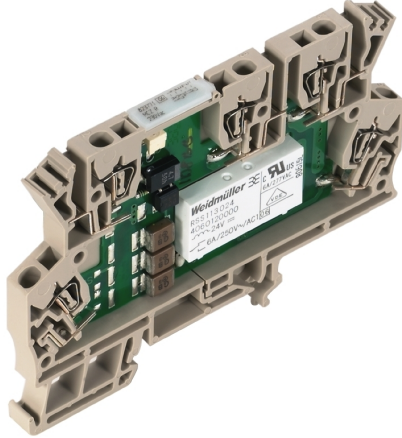

Similar to illustration

Wiring diagram

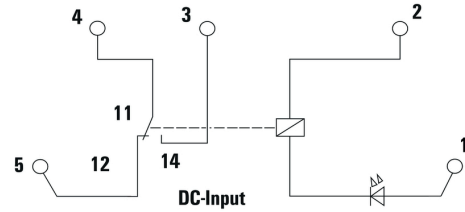

Graph

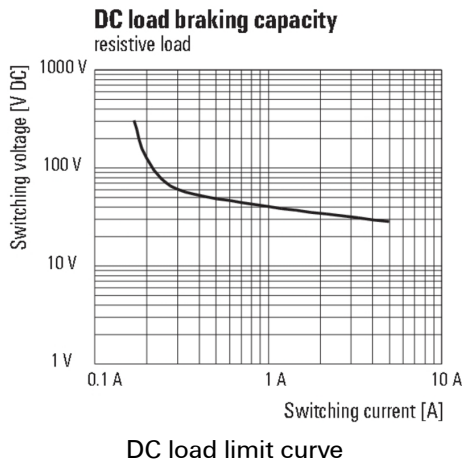

Graph

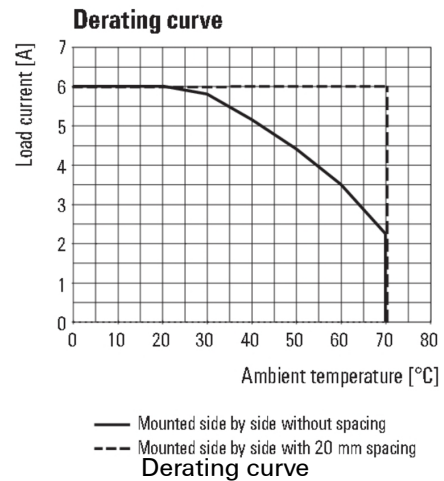

Dimensional drawing

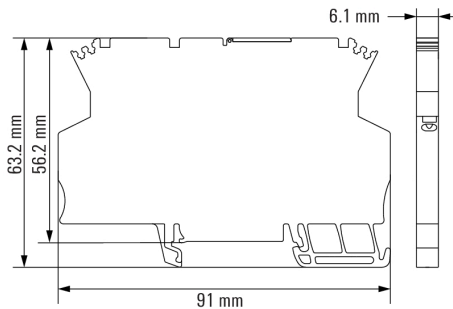

MCZ R 36VDC 1CO AU TRAK

Weidmüller Interface GmbH & Co. KG
 Klingenbergstraße 26
 D-32758 Detmold
 Germany

www.weidmueller.com

Accessories

2.5 mm²

The plug-in cross-connections feature easy handling and quick installation. This saves a great deal of time during installation in comparison with screwed solutions.

General ordering data

Type	ZQV 2.5N/20 SW	Version
Order No.	1909130000	W-Series, Cross-connector, For the terminals, Number of poles: 20
GTIN (EAN)	4032248535910	
Qty.	20 pc(s).	

Slotted screwdriver



VDE insulated screwdriver sets, for working on live parts up to 1000 V AC and 1500 V DC, DIN EN 60900. IEC 900. Each piece is "GS" safety tested. Blade made from fully hardened, high-alloy chromium-vanadium-molybdenum steel, gun-metal finish.

General ordering data

Type	SDIS SLIM 0.6X3.5X100	Version
Order No.	2749610000	Mounting tool, Blade width (B): 3.5 mm, Blade length: 100 mm, Blade thickness (A): 0.6 mm
GTIN (EAN)	4050118896350	
Qty.	1 pc(s).	

MCZ R 36VDC 1CO AU TRAK

Weidmüller Interface GmbH & Co. KG
 Klingenbergstraße 26
 D-32758 Detmold
 Germany

www.weidmueller.com

Accessories

Slotted screwdriver

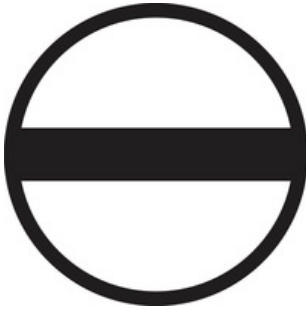

VDE insulated slot-head screwdriver, SDI DIN 7437, ISO 2380/2, drive output acc. to DIN 5264, ISO 2380/1. SoftFinish grip

General ordering data

Type	SDIS 0.6X3.5X100	Version
Order No.	2749810000	Screwdriver, Blade width (B): 3.5 mm, Blade length: 100 mm, Blade thickness (A): 0.6 mm
GTIN (EAN)	4050118897012	
Qty.	1 pc(s).	

Blank



WS markers are the perfect match for the W-series connectors. Thanks to their system compatibility, the WS tags can also be used with the I-series and the Z-series. The large marking surfaces do not only permit long character strings but also multi-line text. WS markers are ideal for labels with long, customised character strings. Thanks to the proven MultiCard format, printing with PrintJet CONNECT oder/or Plotter is possible.

- Can be fitted in strips or individually
- Markers in proven MultiCard format

For custom printing: Please send us a file of our labeling software M-Print PRO or M-Print PRO Online (without installation) for your labeling specifications.

General ordering data

Type	WS 10/6 MC NE WS	Version
Order No.	1828450000	WS, Terminal marker, 10 x 6 mm, Pitch in mm (P): 6.00 Weidmueller,
GTIN (EAN)	4032248350513	Allen-Bradley, white
Qty.	600 pc(s).	

MCZ R 36VDC 1CO AU TRAK

Weidmüller Interface GmbH & Co. KG
 Klingenbergstraße 26
 D-32758 Detmold
 Germany

www.weidmueller.com

Accessories

AP MCZ 1.5 - End plate



Open miniature housing in modular terminal format with five tension clamp connections. A transparent hinged top plate can be used for labelling and provides access to potentiometer and status displays. Plug-in cross-connectors can be used to interconnect the three top connections. A cover plate for closing off the housing is also available.

General ordering data

Type	AP MCZ1.5 1674	Version
Order No.	8389030000	Small housing, OMNIMATE Housing - TERMINALBOX grey-beige, End
GTIN (EAN)	4008190386849	plate, Width: 1.5 mm
Qty.	50 pc(s).	

Slotted screwdriver

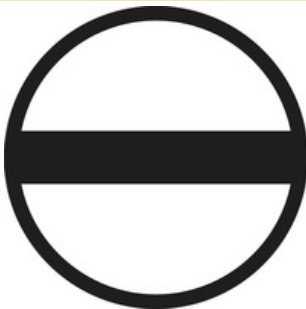

Slotted screwdriver with rounded blade SD DIN 5265, ISO 2380/2, output to DIN 5264, ISO 2380/1. ChromTop tip, SoftFinish grip

General ordering data

Type	SDS 0.6X3.5X100	Version
Order No.	2749340000	Screwdriver, Blade width (B): 3.5 mm, Blade length: 100 mm, Blade
GTIN (EAN)	4050118895568	thickness (A): 0.6 mm
Qty.	1 pc(s).	

MCZ R 36VDC 1CO AU TRAK

Weidmüller Interface GmbH & Co. KG

Klingenbergstraße 26

D-32758 Detmold

Germany

www.weidmueller.com

Accessories

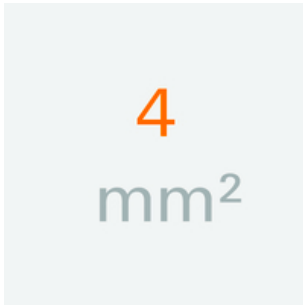
4 mm²

The plug-in cross-connections feature easy handling and quick installation. This saves a great deal of time during installation in comparison with screwed solutions.

General ordering data

Type	ZQV 4N/10	Version
Order No.	1528090000	Cross-connector (terminal), Plugged, Number of poles: 10, Pitch in mm
GTIN (EAN)	4050118332896	(P): 6.10, Insulated: Yes, 32 A, orange
Qty.	20 pc(s).	
Type	ZQV 4N/4 BL	Version
Order No.	1528120000	Cross-connector (terminal), Plugged, Number of poles: 4, Pitch in mm
GTIN (EAN)	4050118332872	(P): 6.10, Insulated: Yes, 32 A, blue
Qty.	60 pc(s).	
Type	ZQV 4N/10 BL	Version
Order No.	1528230000	Cross-connector (terminal), Plugged, Number of poles: 10, Pitch in mm
GTIN (EAN)	4050118333138	(P): 6.10, Insulated: Yes, 32 A, blue
Qty.	20 pc(s).	
Type	ZQV 4N/2 RD	Version
Order No.	2460450000	Cross-connector (terminal), Plugged, Number of poles: 2, Pitch in mm
GTIN (EAN)	4050118476149	(P): 6.10, 32 A, red
Qty.	60 pc(s).	
Type	ZQV 4N/4 RD	Version
Order No.	2460800000	Cross-connector (terminal), Plugged, Number of poles: 4, Pitch in mm
GTIN (EAN)	4050118476224	(P): 6.10, Insulated: Yes, 32 A, red
Qty.	60 pc(s).	
Type	ZQV 4N/2	Version
Order No.	1527930000	Cross-connector (terminal), Plugged, Number of poles: 2, Pitch in mm
GTIN (EAN)	4050118332766	(P): 6.10, Insulated: Yes, 32 A, orange
Qty.	60 pc(s).	
Type	ZQV 4N/3	Version
Order No.	1527940000	Cross-connector (terminal), Plugged, Number of poles: 3, Pitch in mm
GTIN (EAN)	4050118332865	(P): 6.10, Insulated: Yes, 32 A, orange
Qty.	60 pc(s).	
Type	ZQV 4N/2 BL	Version
Order No.	1528040000	Cross-connector (terminal), Plugged, Number of poles: 2, Pitch in mm
GTIN (EAN)	4050118332773	(P): 6.10, Insulated: Yes, 32 A, blue
Qty.	60 pc(s).	
Type	ZQV 4N/4	Version
Order No.	1527970000	Cross-connector (terminal), Plugged, Number of poles: 4, Pitch in mm
GTIN (EAN)	4050118332889	(P): 6.10, Insulated: Yes, 32 A, orange
Qty.	60 pc(s).	
Type	ZQV 4N/3 BL	Version
Order No.	1528080000	Cross-connector (terminal), Plugged, Number of poles: 3, Pitch in mm
GTIN (EAN)	4050118333008	(P): 6.10, Insulated: Yes, 32 A, blue
Qty.	60 pc(s).	

Creation date March 12, 2024 4:06:22 PM CET

Catalogue status 09.03.2024 / We reserve the right to make technical changes.

8

MCZ R 36VDC 1CO AU TRAK

Weidmüller Interface GmbH & Co. KG
 Klingenbergstraße 26
 D-32758 Detmold
 Germany

www.weidmueller.com

Accessories

Type	ZQV 4N/20	Version
Order No.	2883800000	Cross-connector (terminal), Plugged, Number of poles: 20, Pitch in mm
GTIN (EAN)	4064675848769	(P): 6.00, Insulated: Yes, 32 A, orange
Qty.	20 pc(s).	
Type	ZQV 4N/3 RD	Version
Order No.	2460810000	Cross-connector (terminal), Plugged, Number of poles: 3, Pitch in mm
GTIN (EAN)	4050118476231	(P): 6.10, 32 A, red
Qty.	60 pc(s).	
Type	ZQV 4N/10 RD	Version
Order No.	2460740000	Cross-connector (terminal), Plugged, Number of poles: 10, Pitch in mm
GTIN (EAN)	4050118476163	(P): 6.10, 32 A, red
Qty.	20 pc(s).	

4 mm²

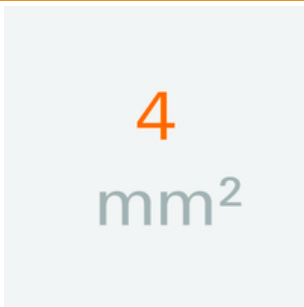

The plug-in cross-connections feature easy handling and quick installation. This saves a great deal of time during installation in comparison with screwed solutions.

General ordering data

Type	ZQV 4N/20 RT	Version
Order No.	1909150000	W-Series, Cross-connector, 32 A
GTIN (EAN)	4032248535934	
Qty.	20 pc(s).	
Type	ZQV 4N/3 SW	Version
Order No.	1794000000	W-Series, Cross-connector, 32 A
GTIN (EAN)	4032248233793	
Qty.	60 pc(s).	
Type	ZQV 4N/20 BL	Version
Order No.	1909100000	W-Series, Cross-connector, 32 A
GTIN (EAN)	4032248535774	
Qty.	20 pc(s).	
Type	ZQV 4N/20 GE	Version
Order No.	1909020000	W-Series, Cross-connector, 32 A
GTIN (EAN)	4032248535644	
Qty.	20 pc(s).	
Type	ZQV 4N/2 SW	Version
Order No.	1793970000	W-Series, Cross-connector, 32 A
GTIN (EAN)	4032248233762	
Qty.	60 pc(s).	
Type	ZQV 4N/10 SW	Version
Order No.	1794060000	W-Series, Cross-connector, 32 A
GTIN (EAN)	4032248234059	
Qty.	20 pc(s).	

Creation date March 12, 2024 4:06:22 PM CET

Data sheet**MCZ R 36VDC 1CO AU TRAK**

Weidmüller Interface GmbH & Co. KG
Klingenbergstraße 26
D-32758 Detmold
Germany

www.weidmueller.com

Accessories

Type	ZQV 4N/4 SW	Version
Order No.	1794030000	W-Series, Cross-connector, 32 A
GTIN (EAN)	4032248233915	
Qty.	60 pc(s).	