

PLEASE CHECK WWW.MOLEX.COM FOR LATEST PART INFORMATION

Part Number: [87782-3005](#)
Status: **Active**
Description: 0.60mm Pitch miniDIMM DDR3 Socket, Vertical, SMT, 0.76µm Gold (Au) over Nickel, 1.5V, with Pick and Place Cover, 244 Circuits, Type A Tray, Lead-Free

Documents:

[3D Model](#) [Application Specification AS-87782-001 \(PDF\)](#)
[Drawing \(PDF\)](#) [RoHS Certificate of Compliance \(PDF\)](#)
[Product Specification PS-87782-027 \(PDF\)](#)

Agency Certification

CSA LR19980
 UL E29179

General

Product Family Memory Module Sockets
 Series [87782](#)
 Comments Latches in Off-White ColorWith Cap
 Component Type Socket
 JEDEC Outline MO-244
 Product Name MiniDIMM
 UPC 883906426224

Physical

Circuits (Loaded) 244
 Color - Resin Black
 Durability (mating cycles max) 25
 Entry Angle Vertical (Top Entry)
 Flammability 94V-0
 Keying to Mating Part Yes
 Material - Metal Copper Alloy
 Material - Plating Mating Gold
 Material - Plating Termination Tin
 Material - Resin High Temperature Thermoplastic
 Net Weight 7.365/g
 PCB Locator Yes
 PCB Retention Yes
 Packaging Type Tray
 Pitch - Mating Interface 0.60mm
 Pitch - Termination Interface 0.60mm
 Plating min - Mating 0.762µm
 Plating min - Termination 2.540µm
 Temperature Range - Operating -55°C to +85°C
 Termination Interface: Style Surface Mount

Electrical

Current - Maximum per Contact 1A
 Voltage - Maximum 30V (RMS)
 Voltage Key 1.5V

Solder Process Data

Duration at Max. Process Temperature (seconds) 5
 Lead-free Process Capability SMC & Wave Capable (TH only)
 Max. Cycles at Max. Process Temperature 2
 Process Temperature max. C 260

Material Info

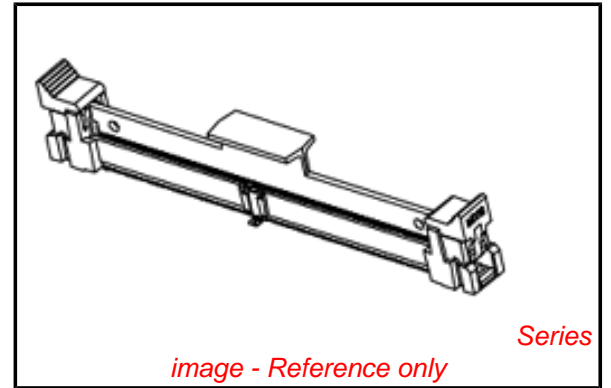

EU RoHS

ELV and RoHS Compliant
REACH SVHC Contains SVHC: No
Low-Halogen Status Not Low-Halogen

China RoHS



Need more information on product environmental compliance?

Email productcompliance@molex.com
 For a multiple part number RoHS Certificate of Compliance, [click here](#)

Please visit the [Contact Us](#) section for any non-product compliance questions.

Search Parts in this Series

[87782Series](#)

Mates With

JEDEC MO-244 Modules

Reference - Drawing Numbers

Application Specification
Electrical Model Document
Product Specification
S-Parameter Model
Sales Drawing

AS-87782-001
EE-87782-001, EE-87782-002, EE-87782-003
PS-87782-027
SP-87782-001
SD-87782-001

This document was generated on 02/04/2013

PLEASE CHECK WWW.MOLEX.COM FOR LATEST PART INFORMATION