

Data sheet | Item number: 859-752

Optocoupler module; Nominal input voltage: 5 VDC; Output voltage range: 0 ... 24 VDC; Limiting continuous current: 0.5 A; Frequency: 10 kHz; gray

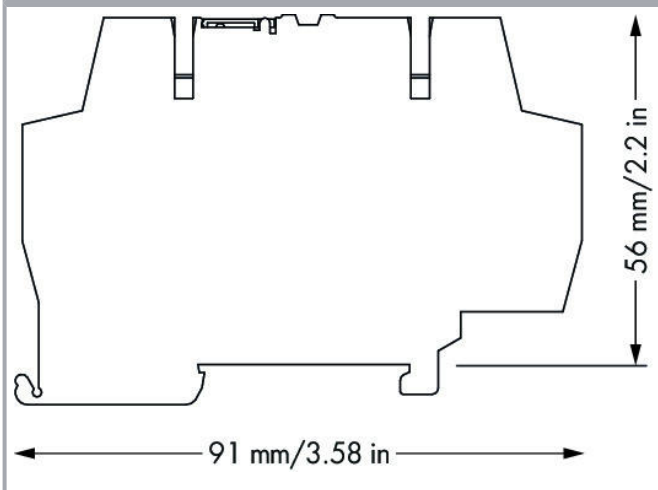

www.wago.com/859-752

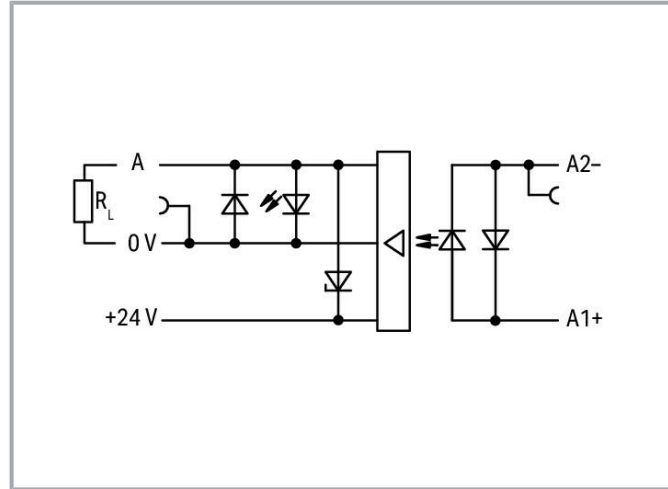
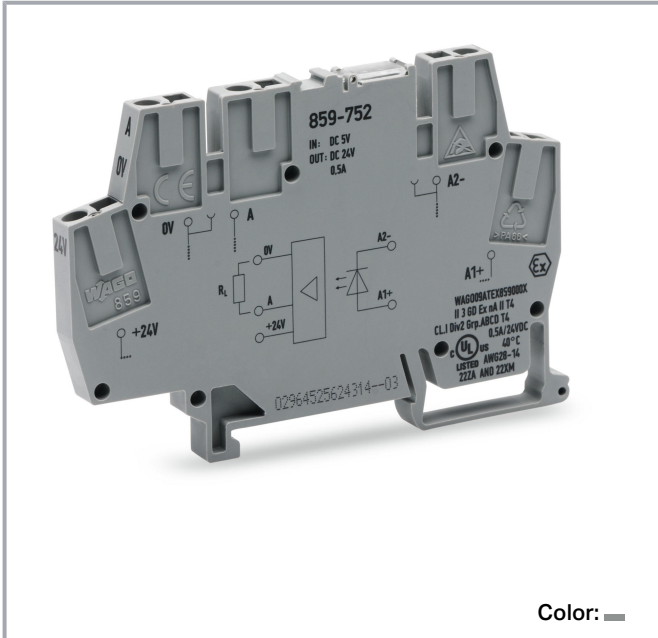

Item description

Note:

Optocouplers and solid state relays are designed for use in signal processing networks, which are not supplied by the low-voltage power supply networks.

Subject to changes. Please also observe the further product documentation!

WAGO Kontakttechnik GmbH & Co. KG
Hansastr. 27
32423 Minden
Phone: +49571 887-0 | Fax: +49571 887-169
Email: info.de@wago.com | Web: www.wago.com

Do you have any questions about our products?
We are always happy to take your call at +49 (571) 887-44222.

Data

Technical data

Control circuit

Nominal input voltage U_N	DC 5 V
Input voltage range (low level)	DC 0 ... 1 V
Input voltage range (high level)	DC 4 ... 6 V
Nominal input current at U_N	10 mA

Load circuit

Circuit type	3-wire connection High-side switching
Limiting continuous current	0.5 A
Nominal output voltage	DC 24 V
Output voltage range	DC 20 ... 30 V
Voltage drop at output (max.)	≤ DC 1.2 V
Leakage current at rated voltage	≤ 10 μA
Output closed-circuit current (without load) (max.)	12.5 mA
Turn-on time	≤ 15 μs
Turn-off time	≤ 30 μs
Switching frequency	≤ 10 kHz

Signaling

Status indicator	Red LED
------------------	---------

Safety and protection

Rated voltage	300 V
Overvoltage category	II
Pollution degree	2
Dielectric strength, control/load circuit (AC, 1 min)	2.5 kVrms
Insulation type (control/load circuit)	Basic insulation
Insulation type (adjacent devices)	Reinforced insulation (safe isolation)

Subject to changes. Please also observe the further product documentation!

Connection data

Connection technology	CAGE CLAMP®
Solid conductor	0.08 ... 2.5 mm ² / 28 ... 14 AWG
Fine-stranded conductor	0.08 ... 2.5 mm ² / 28 ... 14 AWG
Strip length	5 ... 6 mm / 0.2 ... 0.24 inch

Physical data

Width	6 mm / 0.236 inch
Height from upper-edge of DIN-rail	56 mm / 2.205 inch
Depth	91 mm / 3.583 inch

Mechanical data

Mounting type	DIN-35 rail
---------------	-------------

Material data

Color	gray
Fire load	0.313 MJ
Weight	17.8 g

Environmental requirements

Surrounding air temperature (operation at U_N)	-25 ... 40 °C
Surrounding air temperature (storage)	-40 ... 70 °C
Processing temperature	-25 ... +50 °C
Relative humidity	5 ... 95 % (no condensation permissible)
Operating altitude (max.)	2000 m

Standards and specifications

Standards/Specifications	EN 61010-2-201; EN 61000-6-2; EN 61000-6-3; EN 61373; UL 508
--------------------------	--

Commercial data



Product Group	6 (Interface Electronics)
Packaging type	BOX
Country of origin	DE
GTIN	4055143605465

Subject to changes. Please also observe the further product documentation!

Customs tariff number	85365005000
-----------------------	-------------

Approvals / Certificates

Ex-Approvals







Logo	Approval	Additional Approval Text	Certificate name
 Ex nA IIC T4 Gc	CCCEX CQST/CNEx	CNCA-C23-01	2021312304000982
	UL Underwriters Laboratories Inc. (HAZARDOUS LOCATIONS)	ANSI/ISA 12.12.01	E198726

UL-Approvals

Logo	Approval	Additional Approval Text	Certificate name
	UL UL International Netherlands B.V. (ORDINARY LOCATIONS)	UL 508	E175199 Sec.4

Optional accessories

Marking accessories

	Item no.: 2009-145 Mini-WSB Inline; for Smart Printer; 1700 pieces on roll; stretchable 5 - 5.2 mm; plain; snap-on type; white	www.wago.com/2009-145
	Item no.: 210-110 Fiber-tip pen	www.wago.com/210-110
	Item no.: 248-501 Mini-WSB marking card; as card; not stretchable; plain; snap-on type; white	www.wago.com/248-501
	Item no.: 248-502 Mini-WSB marking card; as card; MARKED; 1 ... 10 (10x); not stretchable; Horizontal marking; snap-on type; white	www.wago.com/248-502
	Item no.: 248-503 Mini-WSB marking card; as card; MARKED; 11 ... 20 (10x); not stretchable; Horizontal marking; snap-on type; white	www.wago.com/248-503
	Item no.: 248-504 Mini-WSB marking card; as card; MARKED; 21 ... 30 (10x); not stretchable; Horizontal marking; snap-on type; white	www.wago.com/248-504
	Item no.: 248-506 Mini-WSB marking card; as card; MARKED; 41 ... 50 (10x); not stretchable; Horizontal marking; snap-on	www.wago.com/248-506

Subject to changes. Please also observe the further product documentation!

type; white

tools

**Item no.: 210-720**

Operating tool; Blade: 3.5 x 0.5 mm; with a partially insulated shaft; multicoloured

www.wago.com/210-720

Jumper

**Item no.: 859-402**

Jumper; for jumper slot; 2-way; insulated; light gray

www.wago.com/859-402**Item no.: 859-402/000-005**

Jumper; for jumper slot; 2-way; insulated; red

www.wago.com/859-402/000-005**Item no.: 859-402/000-006**

Jumper; for jumper slot; 2-way; insulated; blue

www.wago.com/859-402/000-006**Item no.: 859-402/000-029**

Jumper; for jumper slot; 2-way; insulated; yellow

www.wago.com/859-402/000-029**Item no.: 859-403**

Jumper; for jumper slot; 3-way; insulated; light gray

www.wago.com/859-403**Item no.: 859-403/000-005**

Jumper; for jumper slot; 3-way; insulated; red

www.wago.com/859-403/000-005**Item no.: 859-403/000-006**

Jumper; for jumper slot; 3-way; insulated; blue

www.wago.com/859-403/000-006**Item no.: 859-403/000-029**

Jumper; for jumper slot; 3-way; insulated; yellow

www.wago.com/859-403/000-029**Item no.: 859-404**

Jumper; for jumper slot; 4-way; insulated; light gray

www.wago.com/859-404**Item no.: 859-404/000-005**

Jumper; for jumper slot; 4-way; insulated; red

www.wago.com/859-404/000-005**Item no.: 859-404/000-006**

Jumper; for jumper slot; 4-way; insulated; blue

www.wago.com/859-404/000-006**Item no.: 859-404/000-029**

Jumper; for jumper slot; 4-way; insulated; yellow

www.wago.com/859-404/000-029**Item no.: 859-405**

Jumper; for jumper slot; 5-way; insulated; light gray

www.wago.com/859-405

Subject to changes. Please also observe the further product documentation!

WAGO Kontakttechnik GmbH & Co. KG

Hansastr. 27















32423 Minden

Phone: +49571 887-0 | Fax: +49571 887-169

Email: info.de@wago.com | Web: www.wago.com

Do you have any questions about our products?





We are always happy to take your call at +49 (571) 887-44222.

	Item no.: 859-405/000-005 Jumper; for jumper slot; 5-way; insulated; red	www.wago.com/859-405/000-005
	Item no.: 859-405/000-006 Jumper; for jumper slot; 5-way; insulated; blue	www.wago.com/859-405/000-006
	Item no.: 859-405/000-029 Jumper; for jumper slot; 5-way; insulated; yellow	www.wago.com/859-405/000-029
	Item no.: 859-406 Jumper; for jumper slot; 6-way; insulated; light gray	www.wago.com/859-406
	Item no.: 859-406/000-005 Jumper; for jumper slot; 6-way; insulated; red	www.wago.com/859-406/000-005
	Item no.: 859-406/000-006 Jumper; for jumper slot; 6-way; insulated; blue	www.wago.com/859-406/000-006
	Item no.: 859-406/000-029 Jumper; for jumper slot; 6-way; insulated; signal yellow	www.wago.com/859-406/000-029
	Item no.: 859-407 Jumper; for jumper slot; 7-way; insulated; light gray	www.wago.com/859-407
	Item no.: 859-407/000-005 Jumper; for jumper slot; 7-way; insulated; red	www.wago.com/859-407/000-005
	Item no.: 859-407/000-006 Jumper; for jumper slot; 7-way; insulated; blue	www.wago.com/859-407/000-006
	Item no.: 859-407/000-029 Jumper; for jumper slot; 7-way; insulated; yellow	www.wago.com/859-407/000-029
	Item no.: 859-408 Jumper; for jumper slot; 8-way; insulated; light gray	www.wago.com/859-408
	Item no.: 859-408/000-005 Jumper; for jumper slot; 8-way; insulated; red	www.wago.com/859-408/000-005
	Item no.: 859-408/000-006 Jumper; for jumper slot; 8-way; insulated; blue	www.wago.com/859-408/000-006

Subject to changes. Please also observe the further product documentation!

	Item no.: 859-408/000-029 Jumper; for jumper slot; 8-way; insulated; yellow	www.wago.com/859-408/000-029
	Item no.: 859-409 Jumper; for jumper slot; 9-way; insulated; light gray	www.wago.com/859-409
	Item no.: 859-409/000-005 Jumper; for jumper slot; 9-way; insulated; red	www.wago.com/859-409/000-005
	Item no.: 859-409/000-006 Jumper; for jumper slot; 9-way; insulated; blue	www.wago.com/859-409/000-006
	Item no.: 859-409/000-029 Jumper; for jumper slot; 9-way; insulated; yellow	www.wago.com/859-409/000-029
	Item no.: 859-410 Jumper; for jumper slot; 10-way; insulated; light gray	www.wago.com/859-410
	Item no.: 859-410/000-005 Jumper; for jumper slot; 10-way; insulated; red	www.wago.com/859-410/000-005
	Item no.: 859-410/000-006 Jumper; for jumper slot; 10-way; insulated; blue	www.wago.com/859-410/000-006
	Item no.: 859-410/000-029 Jumper; for jumper slot; 10-way; insulated; yellow	www.wago.com/859-410/000-029

ferrule

	Item no.: 216-221 Ferrule; Sleeve for 0.5 mm ² / 20 AWG; insulated; electro-tin plated; white	www.wago.com/216-221
	Item no.: 216-222 Ferrule; Sleeve for 0.75 mm ² / 18 AWG; insulated; electro-tin plated; gray	www.wago.com/216-222
	Item no.: 216-223 Ferrule; Sleeve for 1 mm ² / AWG 18; insulated; electro-tin plated; red	www.wago.com/216-223
	Item no.: 216-224 Ferrule; Sleeve for 1.5 mm ² / AWG 16; insulated; electro-tin plated; black	www.wago.com/216-224
	Item no.: 216-321 Ferrule; Sleeve for 0.25 mm ² / AWG 24; insulated; electro-tin plated; yellow	www.wago.com/216-321
	Item no.: 216-322 Ferrule; Sleeve for 0.34 mm ² / 22 AWG; insulated; electro-tin plated; green	www.wago.com/216-322

check

Subject to changes. Please also observe the further product documentation!



	Item no.: 859-500 Test pin; 1 mm Ø; with solder connection for test wire	www.wago.com/859-500
---	--	--

End plate

	Item no.: 859-525 End and intermediate plate; 1 mm thick; gray	www.wago.com/859-525
---	--	--

Downloads

Documentation

Bid Text

859-752 X81 - Datei	Feb 19, 2019	xml 3.9 kB	Download
859-752 docx - Datei	Feb 20, 2019	docx 15.8 kB	Download

Instruction Leaflet

Relay modules, Optocoupler modules	V 1.2.0 Aug 30, 2019	pdf 2.2 MB	Download
------------------------------------	-------------------------	---------------	----------

Additional Information

Disposal; Electrical and electronic equipment, Packaging	V 1.0.0	pdf 265.8 kB	Download
--	---------	-----------------	----------

CAD/CAE-Data

CAE data

EPLAN Data Portal 859-752	URL	Download
WSCAD Universe 859-752	URL	Download
ZUKEN Portal 859-752	URL	Download

CAD data

2D/3D Models 859-752	URL	Download
----------------------	-----	----------

Subject to changes. Please also observe the further product documentation!

WAGO Kontakttechnik GmbH & Co. KG
 Hansastr. 27
 32423 Minden
 Phone: +49571 887-0 | Fax: +49571 887-169
 Email: info.de@wago.com | Web: www.wago.com

Do you have any questions about our products?
 We are always happy to take your call at +49 (571) 887-44222.

Environmental Product Compliance

Compliance Search

Environmental Product Compliance 859-752

[URL](#)

[Download](#)

Optocoupler module; Nominal input voltage: 5 VDC; Output voltage range: 0 ... 24 VDC; Limiting continuous current: 0.5 A; Frequency: 10 kHz; gray

Installation Notes

Conductor termination

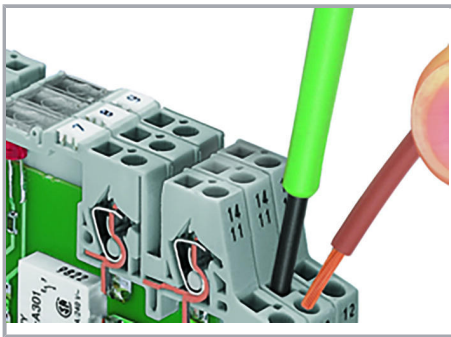

Conductor termination

Commoning

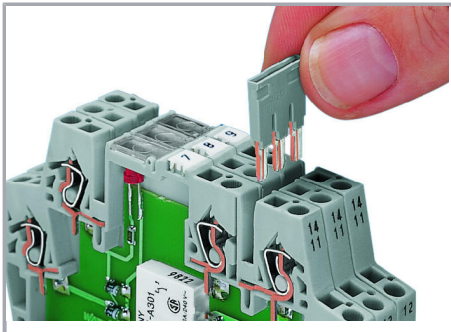

Easy commoning using adjacent jumpers

Marking

Subject to changes. Please also observe the further product documentation!



Marking via Mini-WSB Quick Marking System

Subject to changes. Please also observe the further product documentation!