

PLEASE CHECK WWW.MOLEX.COM FOR LATEST PART INFORMATION

Part Number: [0855025011](#)
Status: **Active**
Overview: [modular_plugs_jacks](#)
Description: Modular Jack, Right Angle, Low Profile, SMT, 6/6, Pin-in-Hole- Reflow, Gold (Au)

Documents:

[3D Model](#) [Application Specification AS-85513-001 \(PDF\)](#)
[Drawing \(PDF\)](#) [RoHS Certificate of Compliance \(PDF\)](#)
[Product Specification PS-85502-001 \(PDF\)](#)

Agency Certification

UL E107635

General

Product Family	Modular Jacks/Plugs
Series	85502
Comments	Pin and Paste
Component Type	PCB Jack
Magnetic	No
Overview	modular_plugs_jacks
Performance Category	3
Power over Ethernet (PoE)	N/A
Product Name	RJ12

Physical	
Color - Resin	Black
Durability (mating cycles max)	500
Flammability	94V-0
Inverted / Top Latch	No
Lightpipes/LEDs	None
Material - Metal	Copper Alloy
Material - Plating Mating	Gold
Material - Plating Termination	Tin
Material - Resin	High Temperature Thermoplastic
Orientation	Right Angle (Side Entry)
PCB Locator	Yes
PCB Retention	Yes
PCB Thickness - Recommended	1.57mm
Packaging Type	Embossed Tape on Reel
Pitch - Mating Interface	1.02mm
Pitch - Termination Interface	1.27mm
Ports	1
Positions / Loaded Contacts	6/6
Surface Mount Compatible (SMC)	Yes
Temperature Range - Operating	-40°C to +80°C
Termination Interface: Style	Surface Mount
Waterproof / Dustproof	No
Wire/Cable Type	N/A

Electrical

Current - Maximum per Contact	1.5A
Shielded	No
Voltage - Maximum	125V AC (RMS)

Solder Process Data

Duration at Max. Process Temperature (seconds)	45
Lead-free Process Capability	Reflow Capable (SMT only)

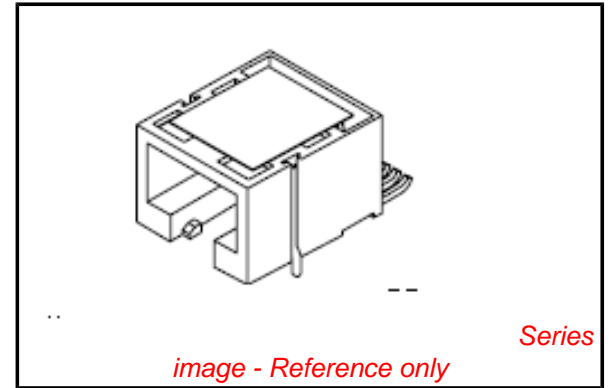

EU RoHS

**ELV and RoHS
Compliant**
**REACH SVHC
Contains SVHC: No**
**Low-Halogen Status
Low-Halogen**

China RoHS



**Need more information on product
environmental compliance?**

Email productcompliance@molex.com
For a multiple part number RoHS Certificate of Compliance, [click here](#)

Please visit the [Contact Us](#) section for any non-product compliance questions.

Search Parts in this Series

[85502Series](#)

Mates With

FCC 68 Plugs

Max. Cycles at Max. Process Temperature	3
Process Temperature max. C	260

Material Info

Reference - Drawing Numbers

Application Specification	AS-85513-001
Product Specification	PS-85502-001
Sales Drawing	SD-85502-103

This document was generated on 01/30/2012

PLEASE CHECK WWW.MOLEX.COM FOR LATEST PART INFORMATION