

Product Data Sheet 8452/2HP

ebmpapst

The engineer's choice



8452/2HP

INDEX

1	General	3
2	Mechanics	3
2.1	General.....	3
2.2	Connections.....	3
3	Operating Data	5
3.1	Electrical Interface - Input.....	5
3.2	Electrical Operating Data	6
3.3	Electrical Interface - Output.....	7
3.4	Electrical Features.....	8
3.5	Aerodynamics.....	9
3.6	Sound Data.....	10
4	Environment	10
4.1	General.....	10
4.2	Climatic Requirements	10
4.3	EMC.....	10
5	Safety	12
5.1	Electrical Safety.....	12
5.2	Approval Tests	12
6	Reliability	12
6.1	General.....	12

1 General

Fan type	Fan	
Rotating direction looking at rotor	Counterclockwise	
Airflow direction	Air outlet over struts	
Bearing system	Ball bearing	
Mounting position - shaft	Any	

2 Mechanics**2.1 General**

Width	80,0 mm	
Height	80,0 mm	
Depth	25,0 mm	
Mass	0,110 kg	
Housing material	Plastic	
Impeller material	Plastic	
Max. torque when mounted across both mounting flanges Screw size	Wire outlet corner: 30 Ncm Remaining corners: 50 Ncm ISO 4762 - M4 degreased, without an additional brace and without washer	

2.2 Connections

Electrical connection	Wires	
Lead wire length	L = 310 mm	
Tolerance	+ - 10,0 mm	

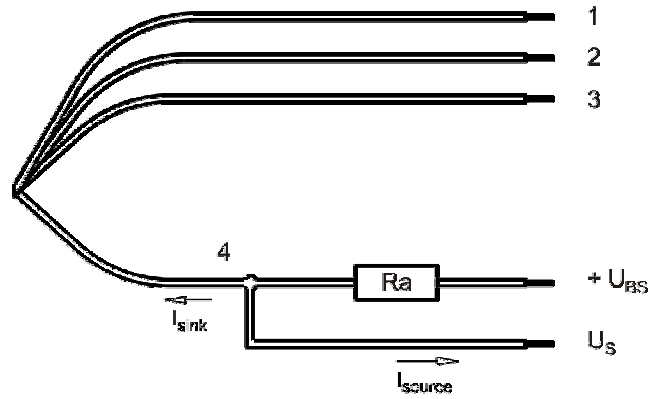

Wire	Color	Operation	Wire size	Insulation diameter
1	red	+ UB	AWG 24	1,55 mm
2	blue	- GND	AWG 24	1,55 mm
3	white	Tacho	AWG 24	1,55 mm
4	violet	PWM	AWG 24	1,55 mm

The auxiliaries shown on the schematic diagram (which are required for the intended use) are not part of our delivery.

3 Operating Data

3.1 Electrical Interface - Input

Control input	PWM
---------------	-----

Features

Input type	Open collector	
PWM - Frequency		21 kHz - 28 kHz typical: 25 kHz
Max. voltage for logic "Low"		0,8 V
Max. voltage for logic "High"	Open circuit voltage	5,25 V
Maximum source current	short circuit current	5 mA
4 wire startup condition	PWM duty cycle	> 25 %
4 wire operation condition after startup	PWM duty cycle	20 % - 100 %
Shutdown condition	PWM duty cycle	< 1 %
Typical time until warm restart	After shutdown by PWM	1,2 s

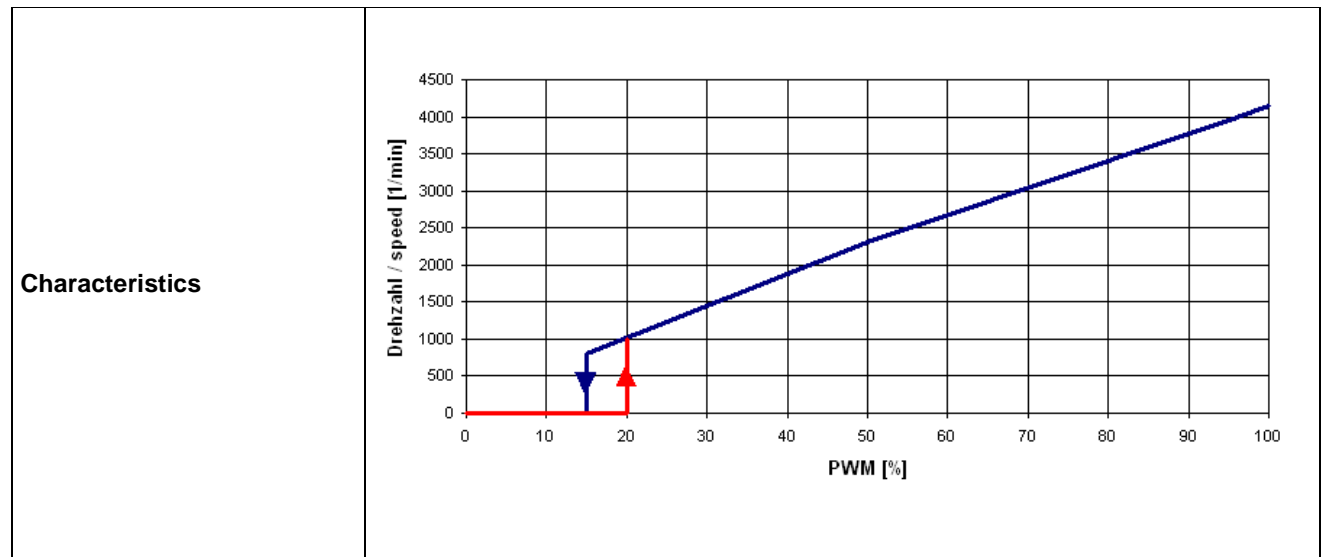

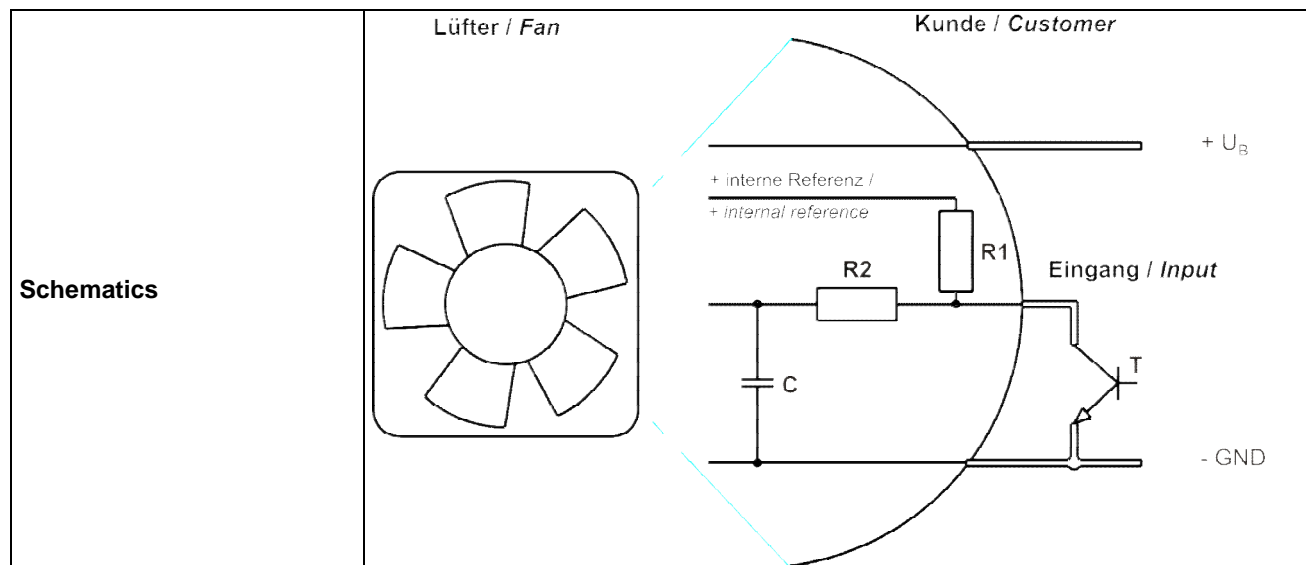

3.2 Electrical Operating Data

Measurement conditions: Normal air density = 1,2 kg/m³; Temperature 23°C +/- 3°C; Motor axis horizontal; warm-up time before measuring 5 minutes (unless otherwise specified). In the intake and outlet area should not be any solid obstruction within 0,5 m.

$\Delta p = 0$: corresp. to free air flow (see chapter aerodynamics)
 I: corresp. to arithm. mean current value

Name	Condition
PWM 0001	PWM: 100 %; f: 25 kHz

Features	Condition	Symbol	Values		
Voltage range		U	10,8 V		13,2 V
Nominal voltage		U_N		12,0 V	
Power consumption	$\Delta p = 0$	P	2,1 W	2,6 W	3,2 W
Tolerance	PWM 0010		+/- 17,5 %	+/- 12,5 %	+/- 15,0 %
Current consumption	$\Delta p = 0$	I	195 mA	220 mA	245 mA
Tolerance	PWM 0010		+/- 17,5 %	+/- 12,5 %	+/- 15,0 %
Speed	$\Delta p = 0$	n	3.650 1/min	4.000 1/min	4.250 1/min
Tolerance	PWM 0010		+/- 12,5 %	+/- 7,5 %	+/- 10,0 %
Starting current consumption				650 mA	

3.3 Electrical Interface - Output

Tacho type	/2 (open collector)
------------	---------------------

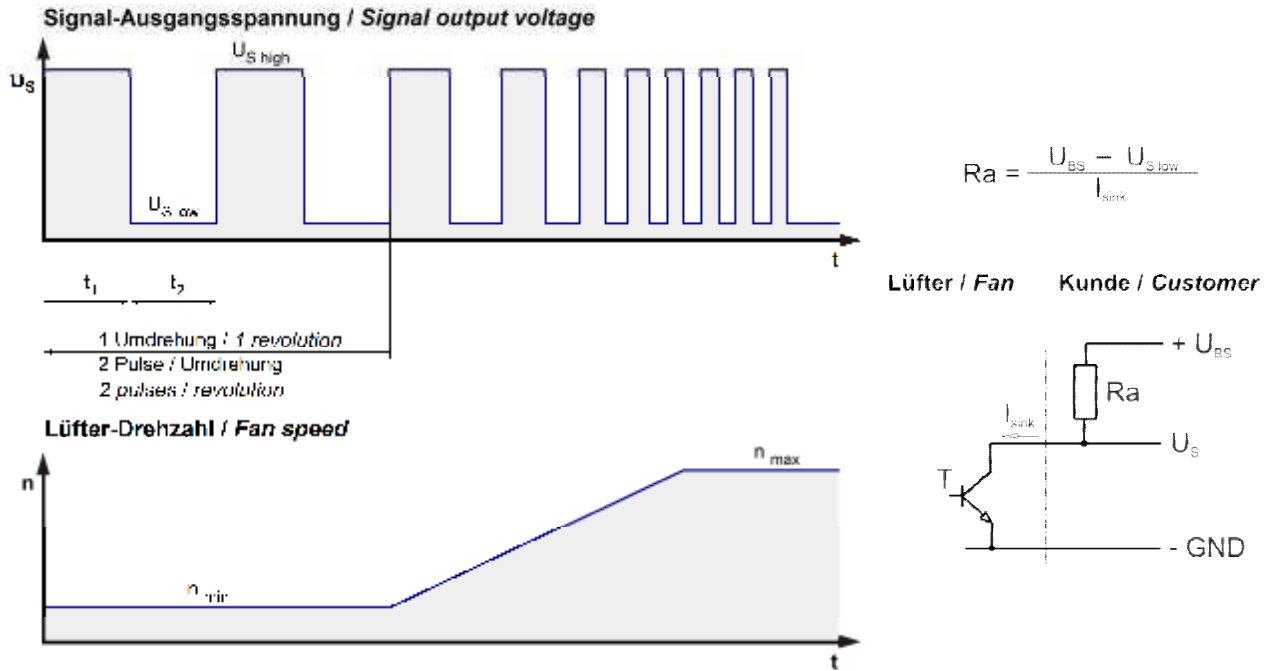

Features	Note	Values
Tacho operating voltage	U_{BS}	≤ 28 V
Tacho signal Low	$U_{S,low}$	$I_{sink}: 2$ mA $\leq 0,4$ V
Tacho signal High	$U_{S,high}$	$I_{source}: 0$ mA 28 V
Maximum sink current	I_{sink}	≤ 4 mA
External resistor	External resistor R_a from U_{BS} to U_S required. All voltages measured to GND.	
Tacho frequency	$(2 \times n) / 60$	120 Hz
Tacho isolated from motor	No	
Slew rate		$\Rightarrow 0,5$ V/us

n = revolutions per minute (1/min)

3.4 Electrical Features

Electronic function	None	
Reversed polarity protection	Rectifying diode	
Max. residual current at U_N	$I_F \leq 10 \text{ mA}$	
Locked rotor protection	Auto restart	
Locked rotor current at U_N	I_{block} approx. 650 mA	
Clock signal at locked rotor	t_3 / t_4 typical: 0,46 s / 2,76 s	

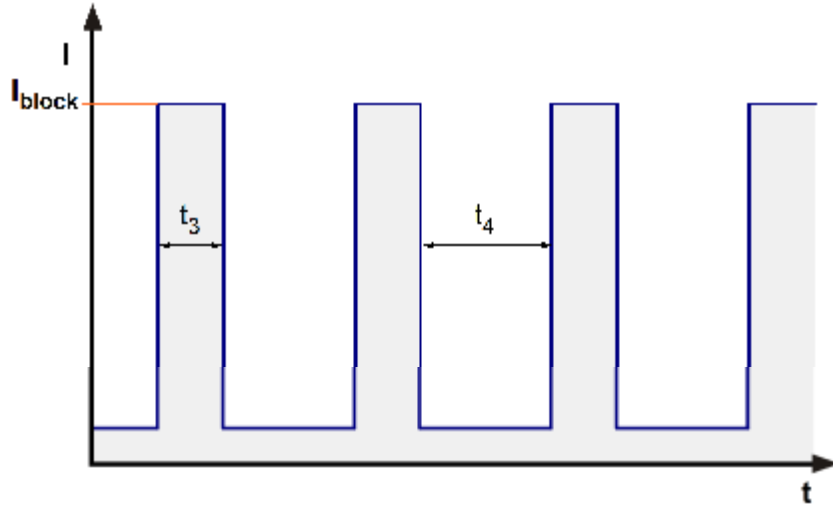

3.5 Aerodynamics

Measurement conditions: Measured with a double chamber intake rig acc. to DIN EN ISO 5801.
 Normal air density = 1,2 kg/m³; Temperature 23°C +/- 3°C;
 In the intake and outlet area should not be any solid obstruction within 0,5 m. Motor shaft horizontal.
 The information is only valid under the specified test conditions and may be changed by the installation conditions. If there are deviations from the standard test conditions, the characteristic values must be checked under the installed conditions.

a.) Operation condition:

4.000 1/min at free air flow	PWM 100 %; f: 25 kHz		
------------------------------	----------------------	--	--

Max. free-air flow ($\Delta p = 0 / \dot{V} = \text{max.}$)	75,0 m ³ /h	
Max. static pressure ($\Delta p = \text{max.} / \dot{V} = 0$)	60 Pa	

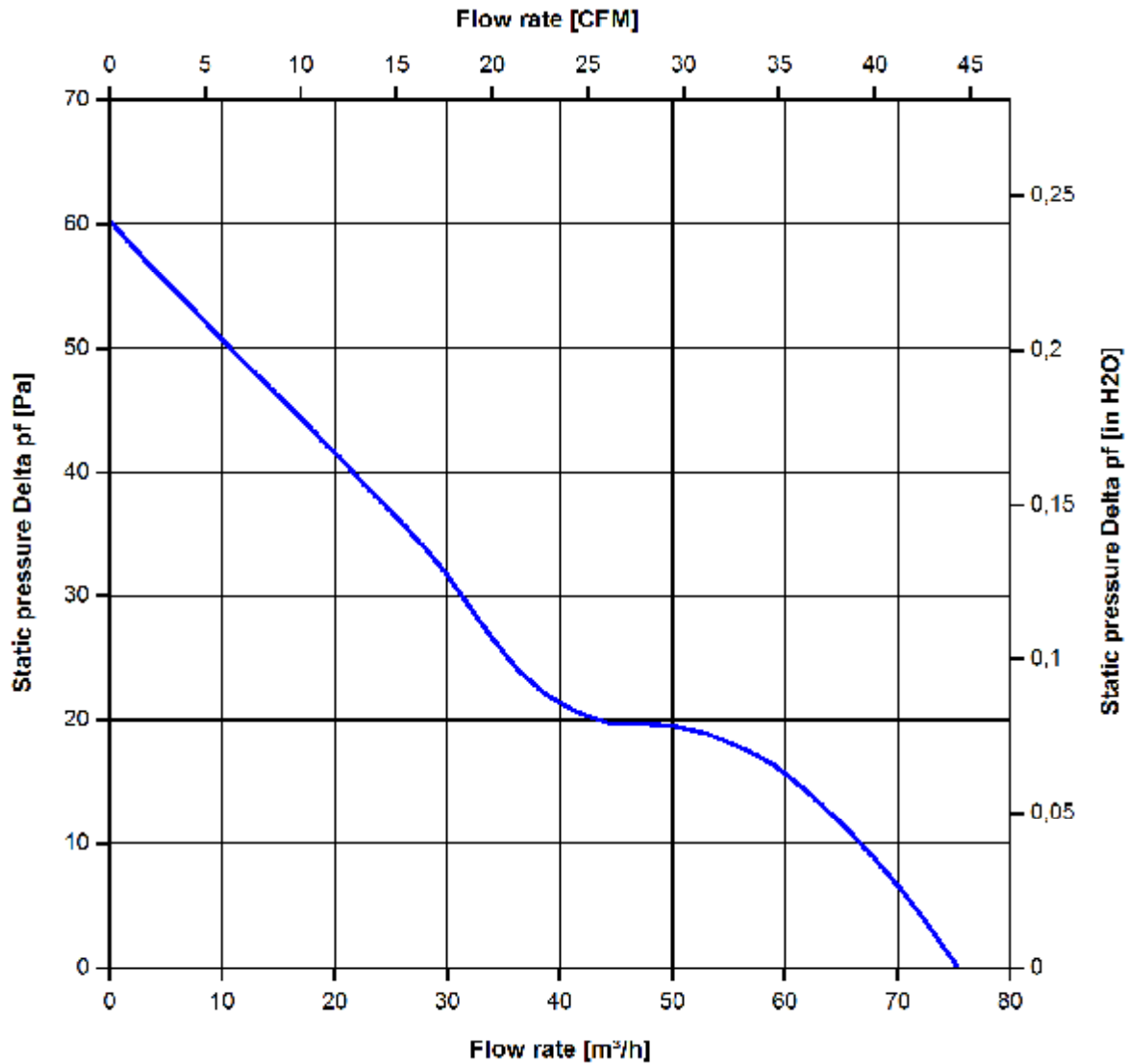

3.6 Sound Data

Measurement conditions: Sound pressure level: 1 meter distance between microphone and the air intake.
 Sound power level: Acc. to DIN 45635 part 38 (ISO 10302)
 Measured in a semianchoic chamber with a background noise level of $L_p(A) < 5 \text{ dB(A)}$
 For further measurement conditions see chapter aerodynamics.

a.) Operation condition:

4.000 1/min at free air flow	PWM 100 %; f: 25 kHz		
------------------------------	----------------------	--	--

Optimal operating point	52,0 m ³ /h @ 19 Pa	
Sound power level at the optimal operating point	5,3 bel(A)	
Sound pressure level at free air flow, measured in rubber bands	38,0 dB(A)	

4 Environment

4.1 General

Min. permitted ambient temperature TU min.	-20 °C	
Max. permitted ambient temperature TU max.	70 °C	
Min. permitted storage temperature TL min.	-40 °C	
Max. permitted storage temperature TL max.	80 °C	

4.2 Climatic Requirements

Humidity requirements	humid heat, constant; according to DIN EN 60068-2-78, 14 days	
Water exposure	None	
Dust requirements	None	
Salt fog requirements	None	

Permitted application area:

The product is intended for use in sheltered rooms with controlled temperature and controlled humidity. Directly exposure to water must be avoided.

Pollution degree 1 (according DIN EN 60664-1)

There is either no pollution or it occurs only dry, non-conductive pollution. The pollution has no negative impact.

Please require severity levels and specification parameters from the responsible development departments.

4.3 EMC

Kind	Conducted Emission; Voltage; 150 kHz-30 MHz
According	DIN EN 55022:2007-04
Check accuracy / Limit	Class B
Result	Below limit Class B

Accordinging	DIN EN 55022:2007-04
Check accuracy / Limit	Class B
Result	Below limit Class B

Kind	Electrostatic Discharge Immunity Test
Accordinging	DIN EN 61000-4-2:2001-12
Check accuracy / Limit	Contact Discharge +/- 4 kV; Air Discharge +/- 8 kV
Result	A: The monitored function operates as designed during and after exposure to a disturbance.

Kind	Electromagnetic Field Immunity Test
Accordinging	DIN EN 61000-4-3:2006-12
Check accuracy / Limit	10 V/m; 80 - 1000 MHz; AM; m = 0,8; f = 1 kHz; 1%; t = 3 s
Result	A: The monitored function operates as designed during and after exposure to a disturbance.

Kind	Electrical Fast Transient / Burst Immunity Test
Accordinging	DIN EN 61000-4-4:2005-07
Check accuracy / Limit	+/- 2 kV on Power Lines; Coupling: POS, NEG, {PE}, ALL, 5 kHz and 100 kHz; 1 min
Result	A: The monitored function operates as designed during and after exposure to a disturbance.

Kind	Immunity to Conducted Disturbances, Induced by RF-Fields
Accordinging	DIN EN 61000-4-6:2001-12
Check accuracy / Limit	10 Vrms; 150 kHz - 80 MHz; m = 0,8; f = 1 kHz; 1%; t = 3 s
Result	A: The monitored function operates as designed during and after exposure to a disturbance.

5 Safety

5.1 Electrical Safety

Dielectric strength DIN EN 60950 (VDE 0805) and DIN EN 60335 (VDE 0700) A.) Type test Measuring conditions: After 48h of storage at 95% R.H. and 25°C. No arcing or breakdown is allowed! All connections together to ground. B.) Routine test Measuring conditions: At indoor climate. No arcing or breakdown is allowed! All connections together to ground.	500 VAC / 1 Min. 850 VDC / 1 Sec.	
Isolation resistance Measuring conditions: After 48h of storage at 95% R.H. and 25°C measured with U=500 VDC for 1 min.	RI > 10 MOhm	
Clearance / creepage distance	1,0 mm / 1,2 mm	
Protection class	III	

5.2 Approval Tests

CE	EC Declaration of Conformity	Yes
EAC	Eurasian Conformity	Yes
UL	Underwriters Laboratories	Yes / UL audited by CSA according to UL507, Electric Fans
VDE	Association for Electrical, Electronic and Information Technologies	Yes / Approval acc. to EN 60950 (VDE 0805) - Information technology equipment
CSA	Canadian Standards Association	Yes / C22.2 No. 113 Fans and Ventilators
CCC	China Compulsory Certification	Not applicable

6 Reliability

6.1 General

Life expectancy L10 at TU = 40 °C	70.000 h	
Life expectancy L10 at TU max.	35.000 h	
Life expectancy L10 acc. to IPC 9591 at TU = 40 °C	117.500 h	

Copying of this document, and giving it others and the use or communication of the contents thereof, are prohibited without express authority. Offenders are liable to the payment of damages. All rights are reserved in the event of the grant of a patent or the registration of a utility model or design.

Abdruckrecht des IKTW 740 10006 beschränkt.
Refer to protection notice DIN ISO 10014 I

nur, wenn in Stückliste enthalten
only when contained in bill of material

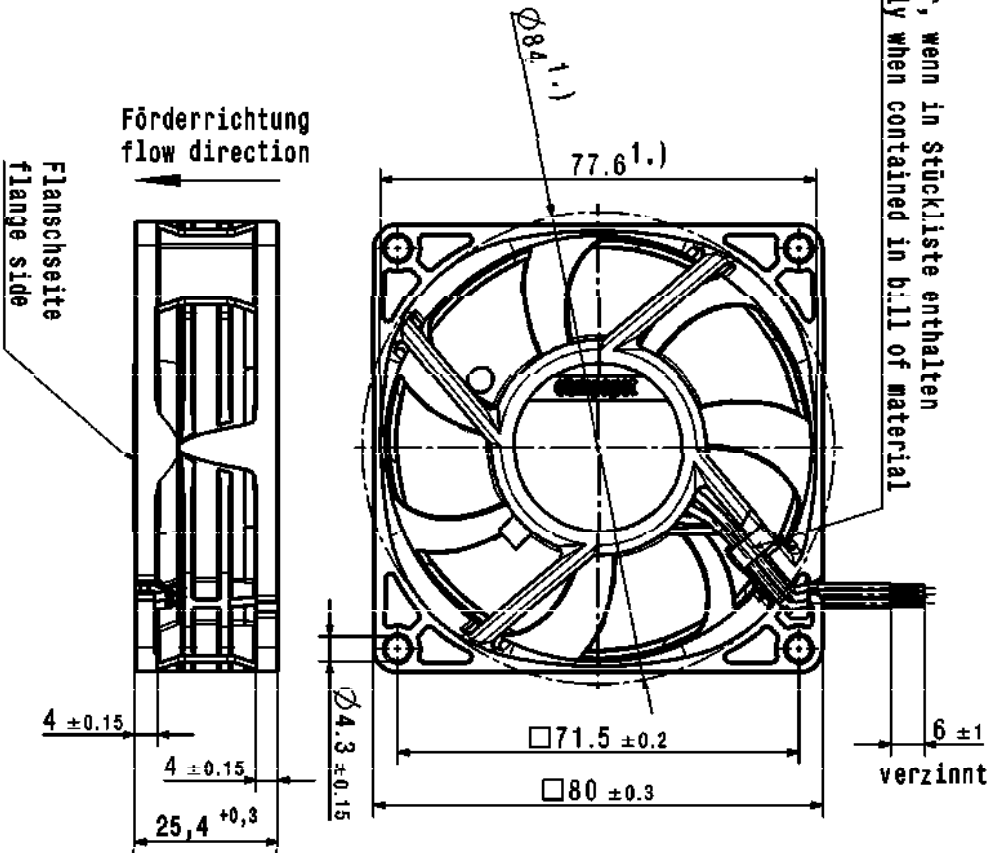

1.) Maße für Montagewand

1.) dimension for worktop mounting
Laenge und Anzahl der Litzen siehe Produktspezifikation.
length and number of the wires, look at the product specification.
Kein Axialspiel bei Kugellager durch Federausgleich.
No axial clearance of ball bearings conditional on a pre-load spring.

Bau-Stufen/Steps 		Mod.-Nr./ Design No.		GÜTE-SYSTEM-NUMMER/ QUALITY-SYSTEM NUMBER		GÜTE-NUMMER/ QUALITY NUMBER	
Vorkategorie / Pre-categorization		Name		Artikel / Article		Volumen / Volume (m ³):	
Allgemeine Anmerkungen / Gen. Remarks:		Lager / Bearing Ø / Dia. Material		Material / Material (Type of Recycled)		Gewicht / Weight (g):	
elmprest		übertrag. St. Oberpin. Seite 4 00 90		Bau- / Baujahr / Year / Year		Preis / Price	
elmprest		übertrag. St. Oberpin. Seite 4 00 90		Bau- / Baujahr / Year / Year		Preis / Price	