

Product Data Sheet **8315100126**
VWLG150KKLSS
AF172-00126 48V P/2U
7.800

ebmpapst

engineering a better life



AF172-00126 48V P/2U 7.800

INDEX

1 General 3

2 Mechanics 3

2.1 General 3

2.2 Connections 3

3 Operating Data 5

3.1 Electrical Interface - Input 5

3.2 Electrical Operating Data 6

3.3 Electrical Interface - Output 7

3.4 Electrical Features 8

3.5 Data According ErP Directive 8

3.6 Aerodynamics 9

3.7 Sound Data 10

4 Environment 10

4.1 General 10

4.2 Climatic Requirements 10

4.3 EMC 10

5 Safety 12

5.1 Electrical Safety 12

5.2 Approval Tests 12

6 Reliability 12

6.1 General 12

1 General

Fan type	Axial	
Rotating direction looking at rotor	Counterclockwise	
Airflow direction	Air outlet over struts	
Bearing system	Ball bearing	
Mounting position - shaft	Any	

2 Mechanics**2.1 General**

Width	150,0 mm	
Depth	51,0 mm	
Diameter	172,0 mm	
Mass	0,95 kg	
Housing material	Metal	
Impeller material	Plastic	
Max. torque when mounted across both mounting flanges	Wire outlet corner: 190 Ncm Remaining corners: 190 Ncm	
Screw size	ISO 4762 - M4 degreased, without an additional brace and without washer	

2.2 Connections

Electrical connection	Wires	
Lead wire length	L = 365 mm	
Tolerance	+ - 10,0 mm	
Tube length	S = 10 mm	
Tolerance	+ - 10 mm	

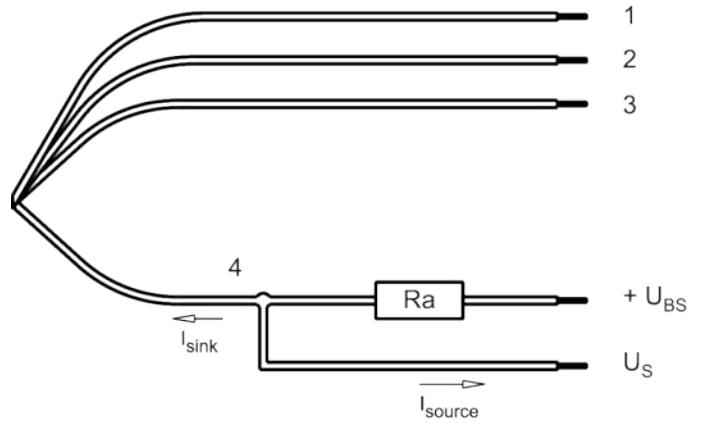

Wire	Color	Operation	Wire size	Insulation diameter
1	red	+ UB	AWG 22	1,7 mm
2	blue	- GND	AWG 22	1,7 mm
3	violet	PWM	AWG 22	1,7 mm
4	white	Tacho	AWG 22	1,7 mm

The auxiliaries shown on the schematic diagram (which are required for the intended use) are not part of our delivery.

3 Operating Data

3.1 Electrical Interface - Input

Control input	PWM
---------------	-----

Features

Inpute type	Open collector	
PWM - Frequency		typical: 2 kHz

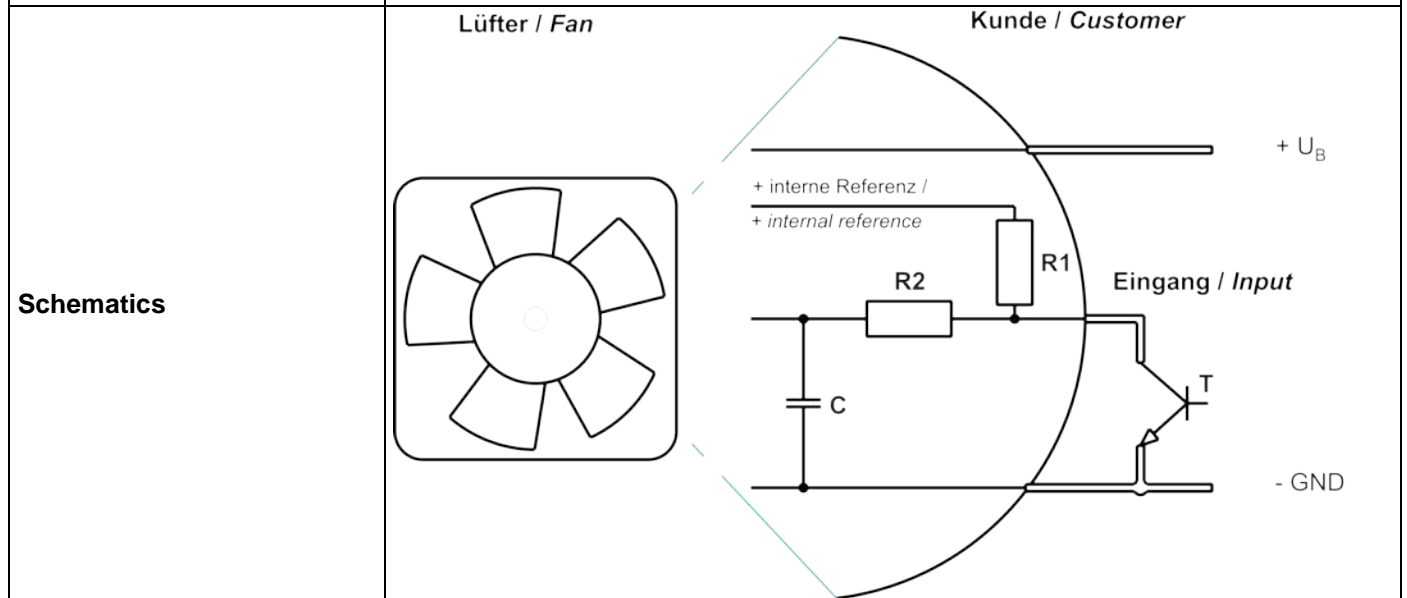
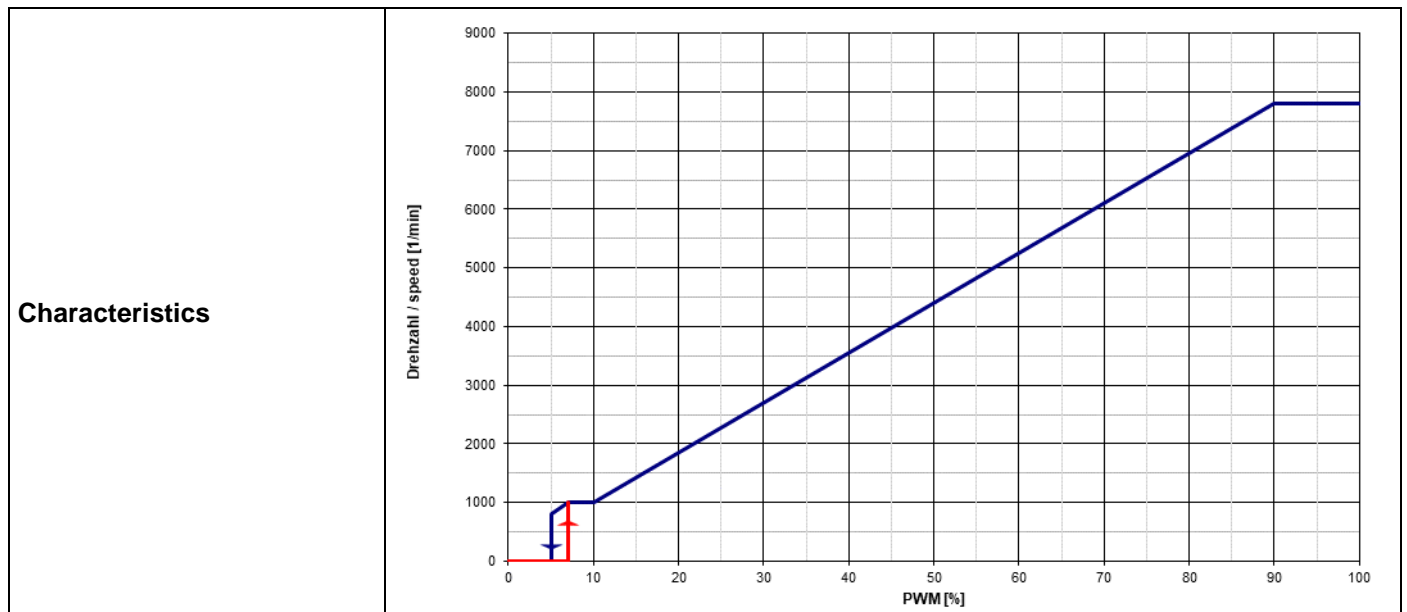

PWM input transistor requirements:
 $U_{CEmax.} \Rightarrow 12\text{ V}$; $I_{Sink\ max.} > 5\text{ mA}$; $U_{CEsat.} < 0,15\text{ V}$

Speed control:

By Puls width modulation (PWM) 0 ... 100%
 Open collector in relation to signal-ground

f = 2kHz +-20%

Information to the curve:

0% - <=7% PWM: 0 1/min (Fan off)
 7% PWM: 1.000 1/min (Start-up, coming from 0% PWM)
 7% - 10 % PWM: 1.000 1/min (corresp. to min fan speed)
 10% - 90% PWM: Linear increasing curve
 90% - 100% PWM: 7.800 1/min (corresp. to max fan speed)
 5% PWM: 800 1/min or 0 1/min (Fan turns off, coming from 100% PWM)

3.2 Electrical Operating Data

Measurement conditions: Normal air density = 1,2 kg/m³; Temperature 23°C +/- 3°C; Motor axis horizontal; warm-up time before measuring 5 minutes (unless otherwise specified). In the intake and outlet area should not be any solid obstruction within 0,5 m.

$\Delta p = 0$: corresp. to free air flow (see chapter aerodynamics)
 I: corresp. to arithm. mean current value

Name	Condition
PWM 0001	PWM: 100 %;

Features	Condition	Symbol	Values		
Voltage range		U	36 V		72 V
Nominal voltage		U _N		48 V	
Power consumption	$\Delta p = 0$	P	64 W	80 W	84 W
Tolerance	PWM 0010		+/- 15 %	+/- 15 %	+/- 15 %
Current consumption	$\Delta p = 0$	I	1.777 mA	1.666 mA	1.150 mA
Tolerance	PWM 0010		+/- 15 %	+/- 15 %	+/- 15 %
Speed	$\Delta p = 0$	n	7.300 1/min	7.800 1/min	7.800 1/min
Tolerance	PWM 0010		+/- 10 %	+/- 10 %	+/- 10 %

3.3 Electrical Interface - Output

Tacho type	/2 (open collector)
------------	---------------------

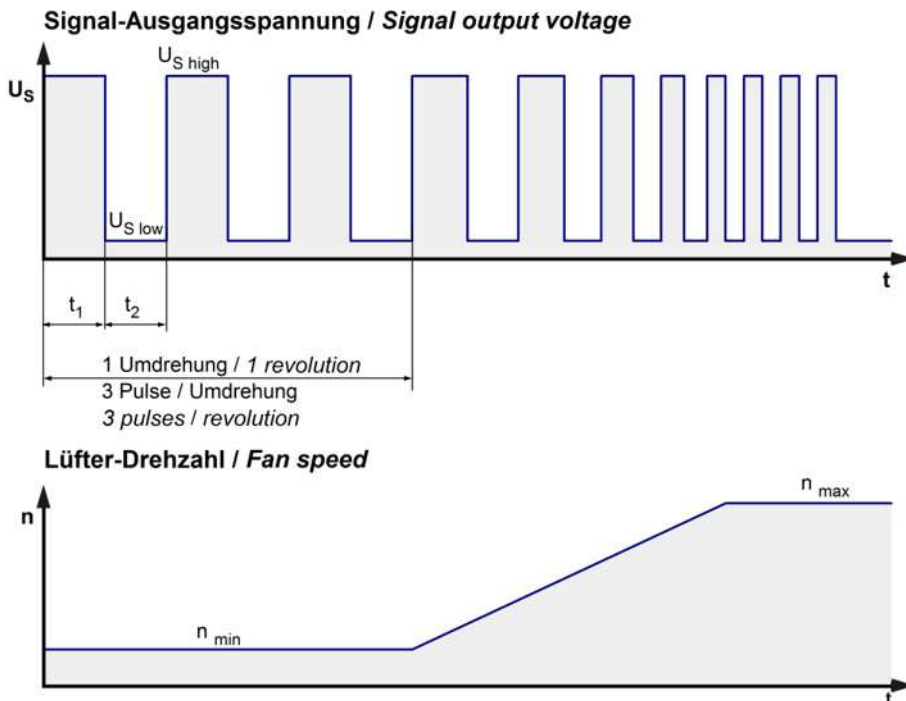

$$R_a = \frac{U_{BS} - U_{S\ low}}{I_{sink}}$$

Lüfter / Fan Kunde / Customer

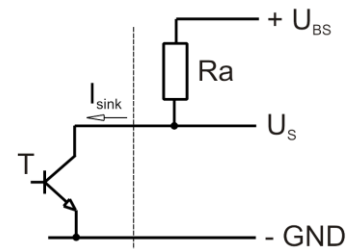

Features	Note	Values
Tacho operating voltage	U_{BS}	$\leq 60\ V$
Tacho signal Low	$U_{S\ low}$	$\leq 0,4\ V$
Tacho signal High	$U_{S\ high}$	
Maximum sink current	I_{sink}	$\leq 20\ mA$
External resistor	External resistor R_a from U_{BS} to U_S required. All voltages measured to GND.	
Tacho frequency	$(3 \times n) / 60$	
Tacho isolated from motor	No	
Slew rate		$\Rightarrow 0,5\ V/\mu s$

n = revolutions per minute (1/min)

3.4 Electrical Features

Electronic function	Speed-Controlled	
Reversed polarity protection	Rectifying diode	
Max. residual current at U_N	$I_F \leq 5$	
Locked rotor protection	Auto restart	
Locked rotor current at U_N	I_{block}	
Clock signal at locked rotor Extended Downtime	t_3 / t_4 typical: 5 s / 10 s t_5 : 30 s after 5 start-up tests	
Internal fuse	Littelfuse NANO2 > Very Fast-Acting > 451/453 Series 6,3A / 125V (Art.No.: 045106.3MRL)	
Voltage control *)	Fan turns on at $U_B > 34$ V or < 74 V Fan turns off at $U_B < 32$ V or > 76 V	

*) This fan has an undervoltage and overvoltage control circuit integrated which turns the motor off if the voltage is out of range.

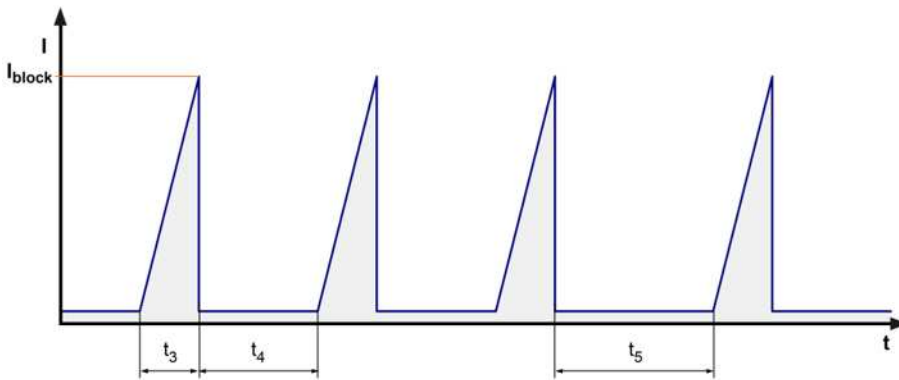

3.5 Data According ErP Directive

Installation / Efficiency category	A / static
Speed control	integrated
Specific ratio	1,00522
Target overall efficiency 2015	28,1 %
Overall efficiency	48,3 %
Efficiency grade	40
Power input	130 W
Speed	7.700 1/min

All values measured in optimum energy efficiency point.

Productiondatecode is printed on the fan label.

3.6 Aerodynamics

Measurement conditions: Measured with a double chamber intake rig acc. to DIN EN ISO 5801. Normal air density = 1,2 kg/m³; Temperature 23°C +/- 3°C; In the intake and outlet area should not be any solid obstruction within 0,5 m. Motor shaft horizontal.

The information is only valid under the specified test conditions and may be changed by the installation conditions. If there are deviations from the standard test conditions, the characteristic values must be checked under the installed conditions. Power consumption of the fan motor when operating at normal voltage is shown. Depending on the operating conditions of the application, the power input may be higher.

a.) Operation condition:

7.800 1/min at free air flow	PWM 100 %;		
------------------------------	------------	--	--

Max. free-air flow ($\Delta p = 0 / \dot{V} = \text{max.}$)	610 m ³ /h	
Max. static pressure ($\Delta p = \text{max.} / \dot{V} = 0$)	825 Pa	

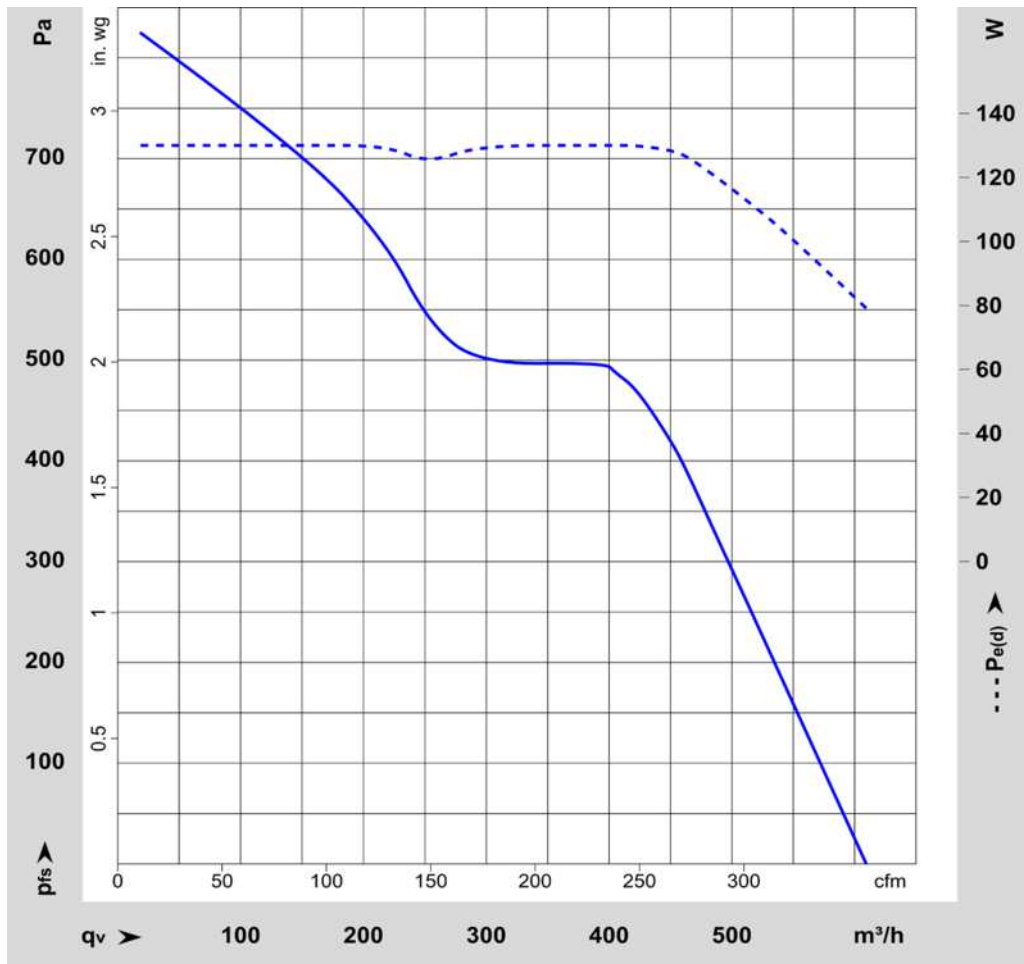

3.7 Sound Data

Measurement conditions: Sound pressure level: 1 meter distance between microphone and the air intake.
 Sound power level: According to ISO 13347-3.
 Measured in a semianechoic chamber with a background noise level of Lp(A) < 5 dB(A)
 For further measurement conditions see chapter aerodynamics.

a.) Operation condition:

7.800 1/min at free air flow	PWM 100 %;		
------------------------------	------------	--	--

Optimal operating point	490 m3/h @ 320 Pa		
Sound power level at the optimal operating point	8 bel(A)		
Sound pressure level at free air flow, measured in rubber bands	69 dB(A)		

4 Environment

4.1 General

Min. permitted ambient temperature TU min.	-20 °C		
Max. permitted ambient temperature TU max.	70 °C		
Min. permitted storage temperature TL min.	-40 °C		
Max. permitted storage temperature TL max.	80 °C		

4.2 Climatic Requirements

Humidity requirements	humid temperature, cyclic; according to DIN EN 60068-2-38, 10 cycle and condensation water check; according to DIN EN ISO 6270-2, 14 days		
Water exposure	Splash water check IPX4; according to DIN EN 60529 VDE 0470, not certified		
Dust requirements	Dust check IP5X; according to DIN EN 60529 VDE 0470, not certified		
Salt fog requirements	None		

Permitted application area:

The product is for the use in partial sheltered rooms or open, roofed areas. Direct exposure to water is allowed provided that this does not prevent the normal operation. Saline ambient conditions must be avoided.

Pollution degree 3 (according DIN EN 60664-1)

It occurs conductive pollution or dry non-conductive pollution which becomes conductive due to condensation.

Please require severity levels and specification parameters from the responsible development departments.

4.3 EMC

Kind	Radiated Emission; 30 MHz - 1000 MHz
Accordinging	DIN EN 55032:2016-02
Ceck accuracy / Limit	Class B
Result	Below limit Class B

Kind	Radiated Emission; 30 MHz - 1000 MHz
Accordinging	DIN EN 55032:2016-02
Ceck accuracy / Limit	Class B
Result	Below limit Class B

Kind	Electrostatic Discharge Immunity Test
Accordinging	DIN EN 61000-4-2:2001-12
Ceck accuracy / Limit	Contact Discharge +/- 4 kV; Air Discharge +/- 8 kV
Result	A: The monitored function operates as designed during and after exposure to a disturbance.

Kind	Electromagnetic Field Immunity Test
Accordinging	DIN EN 61000-4-3:2006-12
Ceck accuracy / Limit	10 V/m; 80 - 1000 MHz; AM; m = 0,8; f = 1 kHz; 1%; t = 3 s
Result	A: The monitored function operates as designed during and after exposure to a disturbance.

Kind	Electrical Fast Transient / Burst Immunity Test
Accordinging	DIN EN 61000-4-4:2005-07
Ceck accuracy / Limit	+/- 2 kV on Power Lines; Coupling: POS, NEG, {PE}, ALL, 5 kHz and 100 kHz; 1 min
Result	A: The monitored function operates as designed during and after exposure to a disturbance.

Kind	Immunity to Conducted Disturbances, Induced by RF-Fields
Accordinging	DIN EN 61000-4-6:2001-12
Ceck accuracy / Limit	10 Vrms; 150 kHz - 80 MHz; AM; m = 0,8; f = 1 kHz; 1%; t = 3 s
Result	A: The monitored function operates as designed during and after exposure to a disturbance.

5 Safety**5.1 Electrical Safety**

Dielectric strength DIN EN 62368 and DIN EN 60335 A.) Type test Measuring conditions: After 48h of storage at 95% R.H. and 25°C. No arcing or breakdown is allowed! All connections together to ground. B.) Routine test Measuring conditions: At indoor climate. No arcing or breakdown is allowed! All connections together to ground.	500 VAC / 1 Min. 850 VDC / 1 Sec.	
Isolation resistance Measuring conditions: After 48h of storage at 95% R.H. and 25°C measured with U=500 VDC for 1 min.	RI > 10 MOhm	
Clearance / creepage distance	1,0 mm / 1,5 mm	
Protection class	I	

5.2 Approval Tests

CE	EC Declaration of Conformity	Yes
EAC	Eurasian Conformity	Yes
UL	Underwriters Laboratories	Yes / UL507, Electric Fans E38324
VDE	Association for Electrical, Electronic and Information Technologies	Yes / Approval acc. to EN 62368 - Audio/video, information and communication technology equipment
CSA	Canadian Standards Association	Yes / CSA audited by UL according to C22.2 No. 113 Fans and Ventilators
CCC	China Compulsory Certification	Yes / GB 12350 Safety Requirements for small Power Motors

6 Reliability**6.1 General**

Life expectancy L10 at TU = 40 °C	70.000 h	
Life expectancy L10 at TU = 60 °C	35.000 h	
Life expectancy L10 acc. to IPC 9591 at TU = 40 °C	117.500 h	

The reproduction, distribution and utilization of this document as well as the communication of its contents to others without express authorization is prohibited. Offenders will be held liable for the payment of damages. All rights reserved in the event of the grant of a patent, utility model or design. Refer to protection notice ISO 102181. Note: In case of multilingual information in this document and in the applicable documents referred to in this document, only the English version shall be authoritative and legally binding in the event of contradictions in content.

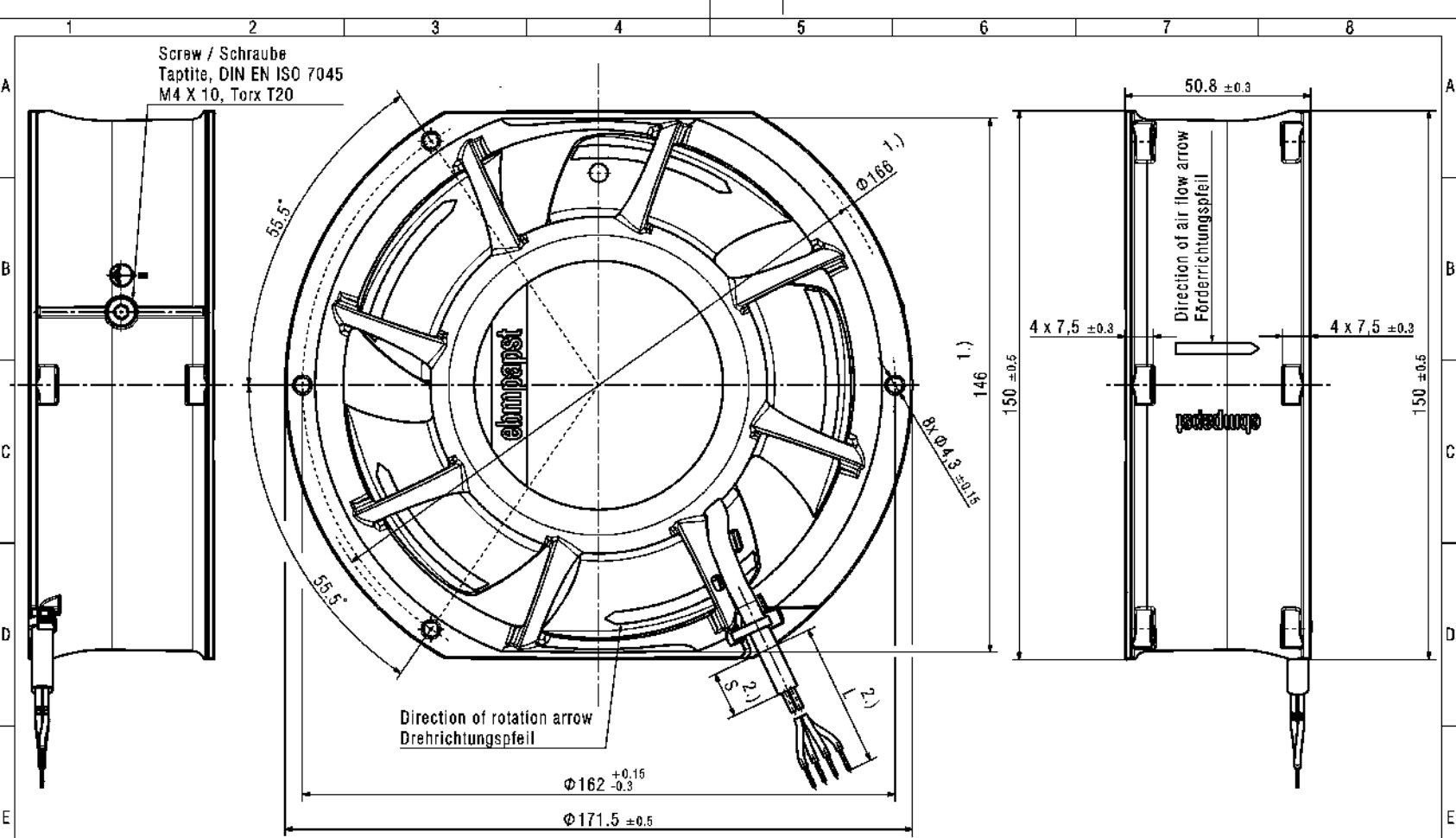

- 1.) Measures of mounting cut out
- 2.) Length and number of wires/tube see product specification
- Ball bearing without clearance by a pre-load spring

- 1.) Maße aus Montageausschnitt
- 2.) Anzahl und Länge der Litzen/Schlauch siehe Produktspezifikation
- Axialspiel der Kugellager mit Feder spielfrei verspannt

Title				Article		Date / Version	
Part number: A				Design name		Design date	
Customer no.				Production name		Production date	
ebmpapst ebm-papst St. Georgen GmbH & Co. KG				Factory		Drawing code	
				Scale		Material	
1. Revision: 01 2. Revision: 02				3. Revision: 03 4. Revision: 04		5. Revision: 05 6. Revision: 06	