

Data Sheet | Item Number: 831-3624

THT male header; 1.0 x 1.2 mm solder pin; angled; 100% protected against mismatching; Pin spacing 7.62 mm; 4-pole; light gray

<https://www.wago.com/831-3624>

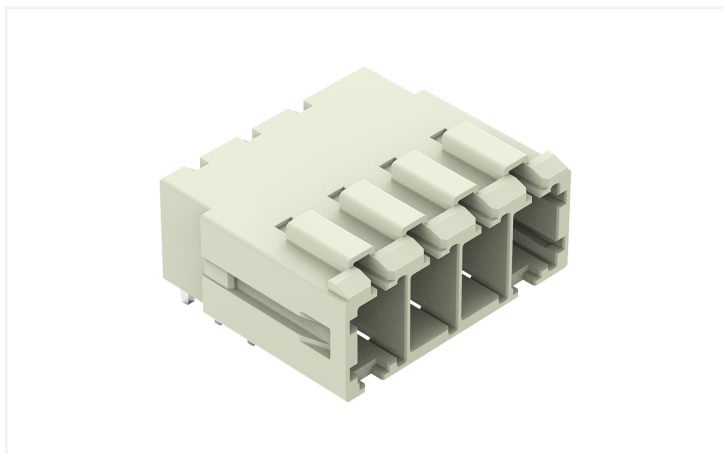

Color: ■ light gray

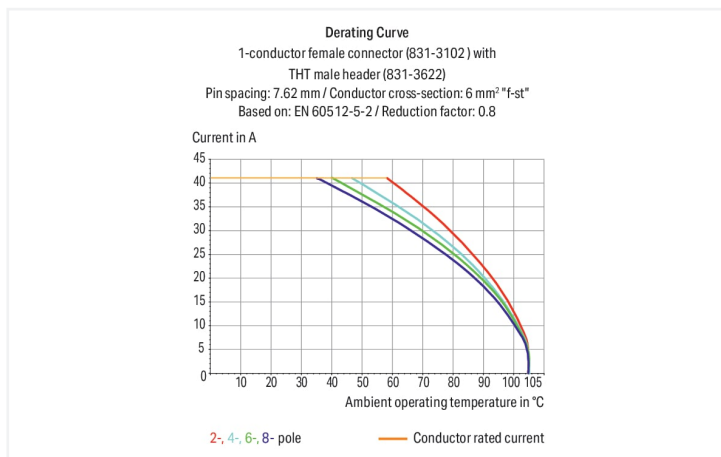
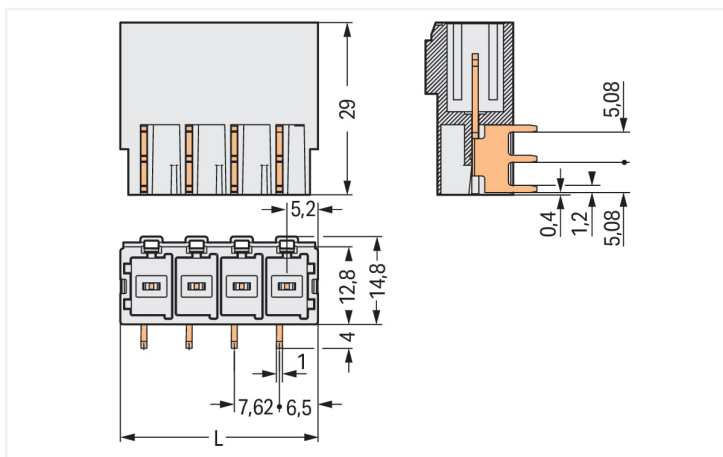
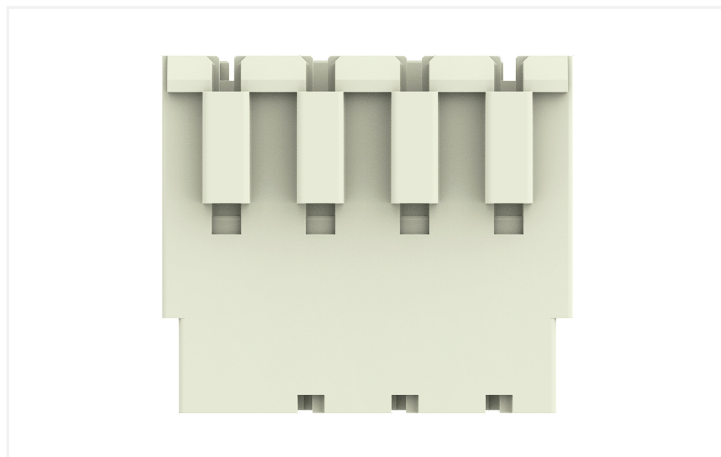
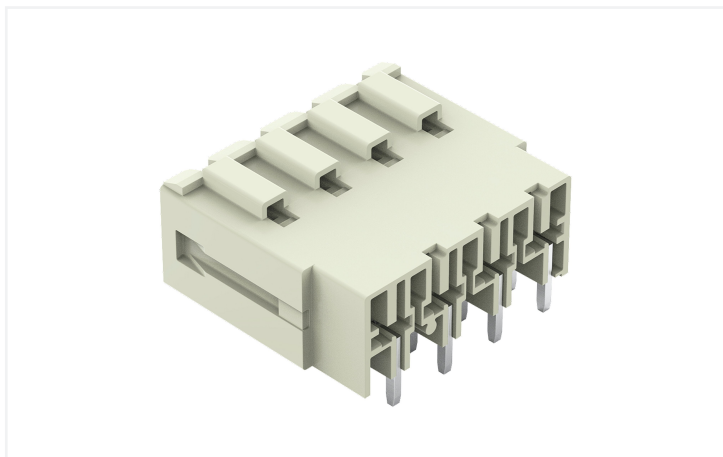

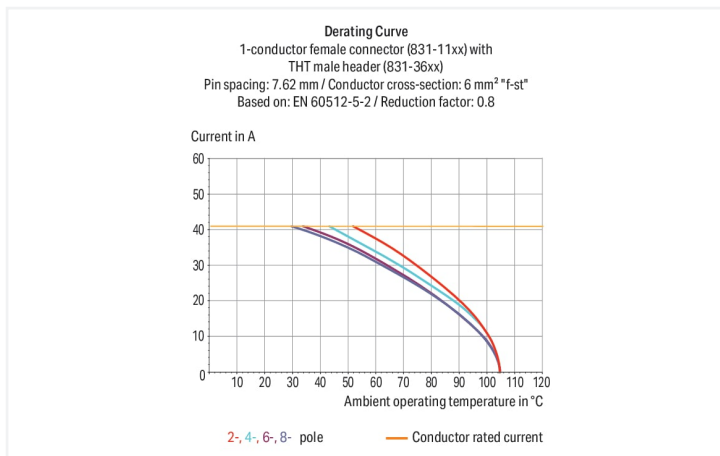

- Male headers may be mounted horizontally or vertically via straight or angled solder pins
- Three solder pins per pole provide high electrical and mechanical stability
- 100 % protected against mismatching
- Coding via coding fingers

Notes

Safety Information

The MCS – *MULTI CONNECTION SYSTEM* includes connectors without breaking capacity in accordance with DIN EN 61984. When used as intended, these connectors must not be connected/disconnected when live or under load. When used as intended, these connectors must not be connected/disconnected when live or under load. The circuit design should ensure header pins, which can be touched, are not live when unmated.

Variants:

Other pole numbers
Protection against PCB mounting errors
Other versions (or variants) can be requested from WAGO Sales or configured at <https://configurator.wago.com/>.

Electrical data

Ratings per		IEC/EN 60664-1			Approvals per		UL 1059		
Overvoltage category		III	III	II	Use group	B	C	D	
Pollution degree		3	2	2	Rated voltage	-	300 V	600 V	
Nominal voltage		500 V	630 V	1000 V	Rated current	-	42 A	5 A	
Rated surge voltage		6 kV	6 kV	6 kV					
Rated current		41 A	41 A	41 A					

Approvals per		CSA		
Use group		B	C	D
Rated voltage		-	300 V	600 V
Rated current		-	41 A	5 A

Connection data

Total number of potentials	4	Connection 1		
Number of connection types	1	Pole number	4	
Number of levels	1			

Physical data

Pin spacing	7.62 mm / 0.3 inches
Width	33.36 mm / 1.313 inches
Height	18.8 mm / 0.74 inches
Height from the surface	14.8 mm / 0.583 inches
Depth	29 mm / 1.142 inches
Solder pin length	4 mm
Solder pin dimensions	1 x 1.2 mm
Drilled hole diameter with tolerance	1.7 ^(+0.1) mm

Mechanical data

Variable coding	Yes
Anti-rotation protection	Yes

Plug-in connection

Contact type (pluggable connector)	Male connector/plug
Connector (connection type)	for PCB
Mismating protection	Yes
Mating direction to the PCB	0°

PCB contact

PCB contact	THT
Solder pin arrangement	over the entire male connector (in-line)
Number of solder pins per potential	3

Material data

Note (material data)	Information on material specifications can be found here
Color	light gray
Material group	I
Insulation material (main housing)	Polyamide (PA66)
Flammability class per UL94	V0
Contact material	Electrolytic copper (E _{CU})
Contact Plating	Tin
Fire load	0.174 MJ
Weight	10.4 g

Environmental requirements

Limit temperature range	-60 ... +105 °C	Environmental Testing (Environmental Conditions)	
Processing temperature	-35 ... +60 °C	Test specification	DIN EN 50155 (VDE 0115-200):2022-06
		Railway applications – Rolling stock – Electronic equipment	
		Test procedure	DIN EN 61373 (VDE 0115-0106):2011-04
		Railway applications – Rolling stock equipment – Shock and vibration tests	
		Spectrum/Installation location	Service life test, Category 1, Class A/B
		Function test with noise-like vibration	Test passed according to Section 8 of the standard
		Frequency	f ₁ = 5 Hz to f ₂ = 150 Hz f ₁ = 5 Hz to f ₂ = 150 Hz
		Acceleration	0.101g (highest test level used for all axes) 0.572g (highest test level used for all axes) 5g (highest test level used for all axes)
		Test duration per axis	10 min. 5 h
		Test directions	X, Y and Z axes X, Y and Z axes X, Y and Z axes
		Monitoring for contact faults/interruptions	Passed
		Voltage drop measurement before and after each axis	Passed
		Simulated service life test through increased levels of noise-like vibration	Test passed according to Section 9 of the standard
		Extended test scope: Monitoring for contact faults/interruptions	Passed Passed
		Extended test scope: Voltage drop measurement before and after each axis	Passed Passed
		Shock test	Test passed according to Section 10 of the standard
		Shock form	Half sine
		Shock duration	30 ms
		Number of shocks per axis	3 pos. und 3 neg.
		Vibration and shock stress for rolling stock equipment	Passed

Commercial data

Product Group	3 (Multi Conn. System)
eCl@ss 10.0	27-44-04-02
eCl@ss 9.0	27-44-04-02
ETIM 9.0	EC002637
ETIM 8.0	EC002637
PU (SPU)	24 pcs
Packaging type	Box
Country of origin	PL
GTIN	4045454002190
Customs tariff number	85366930000

Environmental Product Compliance

RoHS Compliance Status	Compliant, No Exemption
------------------------	-------------------------

Approvals / Certificates

General approvals



Approval	Standard	Certificate Name
CB DEKRA Certification B.V.	IEC 61984	NL-61360/M1
CSA DEKRA Certification B.V.	C22.2	1466354
KEMA/KEUR DEKRA Certification B.V.	EN 61984	71-116057
UR Underwriters Laboratories Inc.	UL 1059	E45172

Declarations of conformity and manufacturer's declarations



Approval	Standard	Certificate Name
Railway WAGO GmbH & Co. KG	-	Railway Ready

Approvals for marine applications



Approval	Standard	Certificate Name
LR Lloyds Register	IEC 61984	96/20035 (E5)

Downloads

Environmental Product Compliance

Compliance Search

Environmental Product
Compliance 831-3624



Documentation

Additional Information			
Technical Section	03.04.2019	pdf 2027.26 KB	↓

CAD/CAE-Data

CAD data	
2D/3D Models 831-3624	↓

CAE data	
EPLAN Data Portal 831-3624	↓
ZUKEN Portal 831-3624	↓















PCB Design

Symbol and Footprint via SamacSys 831-3624	↓
Symbol and Footprint via Ultra Librarian 831-3624	↓

1 Compatible Products

1.1 System counterpart

1.1.1 Female connector/socket

 Item No.: 831-1104 1-conductor female connector; lever; Push-in CAGE CLAMP®; 10 mm²; Pin spacing 7.62 mm; 4-pole; 100% protected against mismatching; 10,00 mm²; light gray	 Item No.: 831-1104/000-004 1-conductor female connector; lever; Push-in CAGE CLAMP®; 10 mm²; Pin spacing 7.62 mm; 4-pole; 100% protected against mismatching; black	 Item No.: 831-1104/320-000 1-conductor female connector; lever; Push-in CAGE CLAMP®; 10 mm²; Pin spacing 7.62 mm; 4-pole; 100% protected against mismatching; Centered locking levers; 10,00 mm²; light gray	 Item No.: 831-1104/322-000 1-conductor female connector; lever; Push-in CAGE CLAMP®; 10 mm²; Pin spacing 7.62 mm; 4-pole; 100% protected against mismatching; Centered locking levers; 10,00 mm²; light gray
 Item No.: 831-1104/037-000 1-conductor female connector; lever; Push-in CAGE CLAMP®; 10 mm²; Pin spacing 7.62 mm; 4-pole; 100% protected against mismatching; Lateral locking levers; 10,00 mm²; light gray	 Item No.: 831-1104/038-000 1-conductor female connector; lever; Push-in CAGE CLAMP®; 10 mm²; Pin spacing 7.62 mm; 4-pole; 100% protected against mismatching; Lateral locking levers; 10,00 mm²; light gray	 Item No.: 831-1105/322-004 1-conductor female connector; lever; Push-in CAGE CLAMP®; 10 mm²; Pin spacing 7.62 mm; 5-pole; 100% protected against mismatching; Centered locking levers; black	 Item No.: 831-3104 1-conductor female connector; Push-in CAGE CLAMP®; 10 mm²; Pin spacing 7.62 mm; 4-pole; 100% protected against mismatching; 10,00 mm²; light gray
 Item No.: 831-3104/000-9037 1-conductor female connector; Push-in CAGE CLAMP®; 10 mm²; Pin spacing 7.62 mm; 4-pole; 100% protected against mismatching; direct marking; 10,00 mm²; light gray	 Item No.: 831-3104/135-000 1-conductor female connector; Push-in CAGE CLAMP®; 10 mm²; Pin spacing 7.62 mm; 4-pole; 100% protected against mismatching; Gripping plate; 10,00 mm²; light gray	 Item No.: 831-3104/037-000 1-conductor female connector; Push-in CAGE CLAMP®; 10 mm²; Pin spacing 7.62 mm; 4-pole; 100% protected against mismatching; Lateral locking levers; 10,00 mm²; light gray	 Item No.: 831-3104/037-9037 1-conductor female connector; Push-in CAGE CLAMP®; 10 mm²; Pin spacing 7.62 mm; 4-pole; 100% protected against mismatching; Lateral locking levers; direct marking; 10,00 mm²; light gray
 Item No.: 831-3524 THT female header; angled; Pin spacing 7.62 mm; 4-pole; 100% protected against mismatching; 1.0 x 1.2 mm solder pin; light gray	 Item No.: 831-3504 THT female header; straight; Pin spacing 7.62 mm; 4-pole; 100% protected against mismatching; 1.0 x 1.2 mm solder pin; light gray		

1.2 Optional Accessories

1.2.1 Coding

1.2.1.1 Coding



Item No.: 831-500

Coding pin carrier with six coding pins;
orange

Installation Notes

Coding

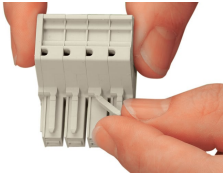

Break or cut off coding pin from female connector.

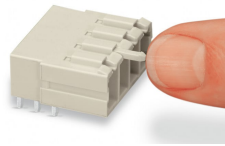

Insert coding pin into male header (break first) until it engages.

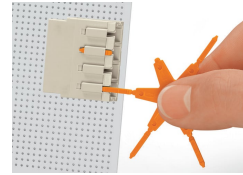

Coding a THT male header by inserting a coding pin.