

8-328975-1 ✓ ACTIVE



PIDG

TE Internal #: 8-328975-1

Closed Ring Tongue Terminal, 22 – 16 AWG, M12 Stud Size, 13.08 mm [.515 in] Stud Diameter, Closed Barrel, Straight, Tin, Partially Insulated, PIDG

[View on TE.com >](#)

Terminals & Splices > Ring Terminals > PIDG Ring Tongue Terminals



Ring Terminal Product Type: Closed Ring Tongue Terminal

Wire Size: 509 – 3260 CMA

Stud Size: M12

[All PIDG Ring Tongue Terminals \(411\)](#)

Features

Product Type Features

Terminal Features	Sheared
Ring Terminal Product Type	Closed Ring Tongue Terminal
Stud Size	M12
Sealable	No
Wire Insulation Support Retention Type	Insulation Support

Configuration Features

Number of Holes	1
-----------------	---

Body Features

Product Weight	1.503 g
----------------	---------

Contact Features

Barrel Type	Closed
Terminal Orientation	Straight
Terminal Plating Material	Tin

Mechanical Attachment



Wire Insulation Support	With
-------------------------	------

Dimensions

Wire Size	509 – 3260 CMA
Stud Diameter	13.08 mm [.515 in]
Tongue Thickness	.79 mm [.031 in]
Product Length	32.84 mm [1.293 in]
Compatible Insulation Diameter (Max)	3.18 mm [.125 in]
Compatible Insulation Diameter Range	2.03 – 3.18 mm [.08 – .125 in]

Usage Conditions

Insulation Option	Partially Insulated
Operating Temperature Range	105 °C [221 °F]

Operation/Application

Compatible With Wire Base Material	Copper
Compatible With Wire Plating Material	Tin

Industry Standards

Government Qualified Terminal	No
-------------------------------	----

Packaging Features

Packaging Quantity	100
Packaging Method	Loose Piece

Product Compliance

[For compliance documentation, visit the product page on TE.com>](#)

EU RoHS Directive 2011/65/EU	Compliant
EU ELV Directive 2000/53/EC	Compliant
China RoHS 2 Directive MIIT Order No 32, 2016	No Restricted Materials Above Threshold
EU REACH Regulation (EC) No. 1907/2006	Current ECHA Candidate List: JUNE 2024 (241) Candidate List Declared Against: JAN 2024 (240) Does not contain REACH SVHC
Halogen Content	Low Halogen - Br, Cl, F, I < 900 ppm per homogenous material. Also BFR/CFR/PVC Free
Solder Process Capability	Not applicable for solder process capability

Product Compliance Disclaimer

This information is provided based on reasonable inquiry of our suppliers and represents our current actual knowledge based on the information they provided. This information is subject to change. The part numbers that TE has identified as EU RoHS compliant have a maximum concentration of 0.1% by weight in homogenous materials for lead, hexavalent chromium, mercury, PBB, PBDE, DBP, BBP, DEHP, DIBP, and 0.01% for cadmium, or qualify for an exemption to these limits as defined in the Annexes of Directive 2011/65/EU (RoHS2). Finished electrical and electronic equipment products will be CE marked as required by Directive 2011/65/EU. Components may not be CE marked. Additionally, the part numbers that TE has identified as EU ELV compliant have a maximum concentration of 0.1% by weight in homogenous materials for lead, hexavalent chromium, and mercury, and 0.01% for cadmium, or qualify for an exemption to these limits as defined in the Annexes of Directive 2000/53/EC (ELV). Regarding the REACH Regulation, the information TE provides on SVHC in articles for this part number is based on the latest European Chemicals Agency (ECHA) 'Guidance on requirements for substances in articles' posted at this URL: <https://echa.europa.eu/guidance-documents/guidance-on-reach>

Compatible Parts



TE Part # 58423-1
DIE, RBY IS9252



TE Part # 47386
DAHT PG PIDG 26-16 ASSY



TE Part # 58433-3
PRO CR ASSY, RBY IS9252



TE Part # 169404
CERTI-LOK DIE



TE Part # 1SET191001R0000
CRIMP-HT

Also in the Series | PIDG



Compression Connectors(17)



Crimp Wire Pins, Tabs & Ferrules(41)



Hand Crimping Tools(2)



Knife Disconnects(11)

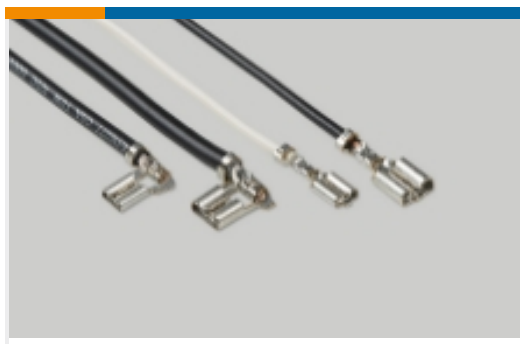

Quick Disconnects(32)



Ring Terminals(589)

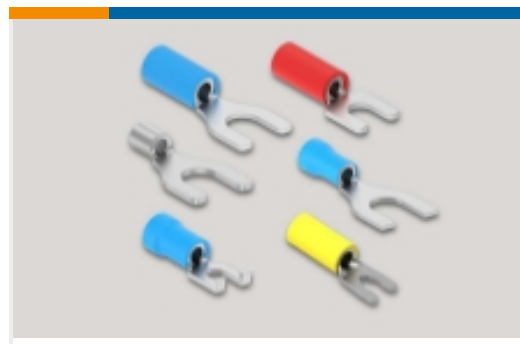

Spade Terminals(228)



Special Purpose Terminals(1)



Splices(40)

Customers Also Bought



TE Part #3-1564412-1
Heavy Duty Sealed Connector Series Housings



TE Part #T4042014041-000
M8.MLE.PNLFRONT.4POS.STR.PCB



TE Part #T4132412051-000
M12,FRONT MOUNT,MALE,B,5P, SOLDER WIRE



TE Part #3-640427-8
08P MTA156 CONN ASSY 20AWG YEL

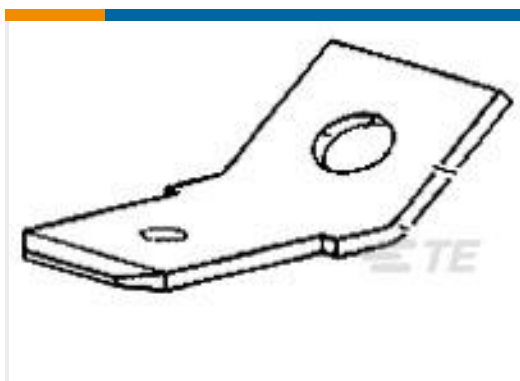

TE Part #61499-1
250 FASTON TAB TPBR

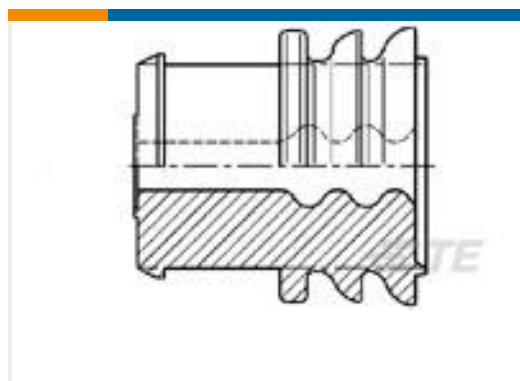

TE Part #100132-1
CAVITY PLUG



TE Part #927835-1
TIMER, RECEPTACLE AND TAB

Documents

Product Drawings

[PIDG R 22-16 COMM 22-18MIL 1/2](#)

English

CAD Files

[3D PDF](#)

[3D](#)

[Customer View Model](#)

[ENG_CVM_CVM_8-328975-1_N.2d_dxf.zip](#)



English

Customer View Model

[ENG_CVM_CVM_8-328975-1_N.3d_igs.zip](#)

English

Customer View Model

[ENG_CVM_CVM_8-328975-1_N.3d_stp.zip](#)

English

By downloading the CAD file I accept and agree to the [Terms and Conditions](#) of use.

[Agency Approvals](#)

[UL Report](#)

English