



FASTON | FASTON 250

TE Internal #: 8-321235-1

Splices, Butt Splice, 22 – 10 AWG Wire Size, .33 – 6 mm² Wire Size, Splice Capacity 1, Brass, Length 2.625 in [66.68 mm], Loose Piece, FASTON 250

[View on TE.com >](#)

Terminals & Splices > Splices



Splice Type: **Butt Splice**

Wire Size: **.33 – 6 mm²**

Sealable: **No**

Splice Capacity: **1**

Features

Product Type Features

Splice Accessory Type	Splice
Splice Type	Butt Splice
Sealable	No

Configuration Features

Splice Capacity	1
-----------------	---

Body Features

Insulation Material	Vinyl
Product Weight	2.993 g

Contact Features

Contact Base Material	Brass
-----------------------	-------

Housing Features

Housing Material	PVC
------------------	-----

Dimensions

Wire Size	.33 – 6 mm ²
-----------	-------------------------



Terminal Material Thickness	.81 mm[.032 in]
-----------------------------	-----------------

Product Length	66.68 mm[2.625 in]
----------------	--------------------

Usage Conditions

Insulation Option	Fully Insulated
-------------------	-----------------

Operating Temperature Range	0 – 105 °C[0 – 221 °F]
-----------------------------	------------------------

Industry Standards

Compatible With Agency/Standards Products	CSA, RU (UL Component Program)
---	--------------------------------

Government Qualified Splice	No
-----------------------------	----

Packaging Features

Packaging Quantity	100
--------------------	-----

Packaging Method	Loose Piece
------------------	-------------

Product Compliance

[For compliance documentation, visit the product page on TE.com>](#)

EU RoHS Directive 2011/65/EU	Compliant
------------------------------	-----------

EU ELV Directive 2000/53/EC	Compliant
-----------------------------	-----------

China RoHS 2 Directive MIIT Order No 32, 2016	No Restricted Materials Above Threshold
---	---

EU REACH Regulation (EC) No. 1907/2006	Current ECHA Candidate List: JUNE 2024 (241) Candidate List Declared Against: JAN 2024 (240) Does not contain REACH SVHC
--	--

Halogen Content	Not Low Halogen - contains Br or Cl > 900 ppm.
-----------------	--

Solder Process Capability	Not applicable for solder process capability
---------------------------	--

Product Compliance Disclaimer

This information is provided based on reasonable inquiry of our suppliers and represents our current actual knowledge based on the information they provided. This information is subject to change. The part numbers that TE has identified as EU RoHS compliant have a maximum concentration of 0.1% by weight in homogenous materials for lead, hexavalent chromium, mercury, PBB, PBDE, DBP, BBP, DEHP, DIBP, and 0.01% for cadmium, or qualify for an exemption to these limits as defined in the Annexes of Directive 2011/65/EU (RoHS2). Finished electrical and electronic equipment products will be CE marked as required by Directive 2011/65/EU. Components may not be CE marked. Additionally, the part numbers that TE has identified as EU ELV compliant have a maximum concentration of 0.1% by weight in homogenous materials for lead, hexavalent chromium, and mercury, and 0.01% for cadmium, or qualify for an exemption to these limits as defined in the Annexes of Directive 2000/53/EC (ELV). Regarding the REACH Regulation, the information TE provides on SVHC in articles for this part number is based on the latest European Chemicals Agency (ECHA) 'Guidance on requirements for substances in articles' posted at this URL: <https://echa.europa.eu/guidance-documents/guidance-on-reach>



Compatible Parts



TE Part # 1-321235-1
RECEIPT, FASTON SPLICE 22-10



TE Part # 63609-2
250 FASTON REC 22-18 AWG TPBR

TE Part # 1SET161005R0000

Also in the Series | FASTON 250



Compression Connectors(4)

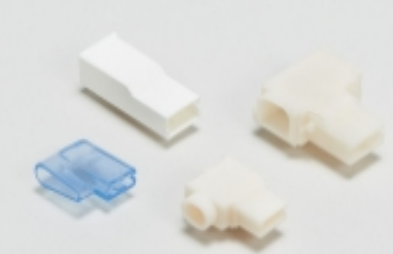

Crimp Terminal Housings(133)



Insertion & Extraction Tools(6)



Magnet Wire Terminals(1)



PCB Terminals(134)



Quick Disconnects(428)



Splices(4)

Customers Also Bought



TE Part #35149
PIDG Ring Tongue Terminals



TE Part #1922530001
Splice Sealing End Cap(ES-Cap)



TE Part #EM7085-000
THA-PDKG-17



TE Part #5205817-1
KIT SCREWLOCK FEMALE

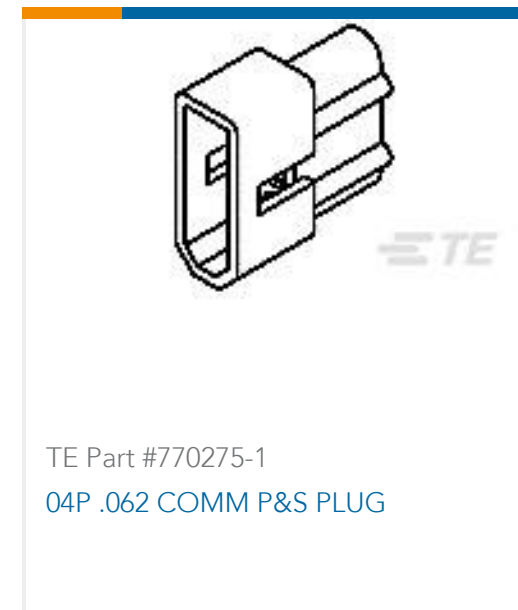
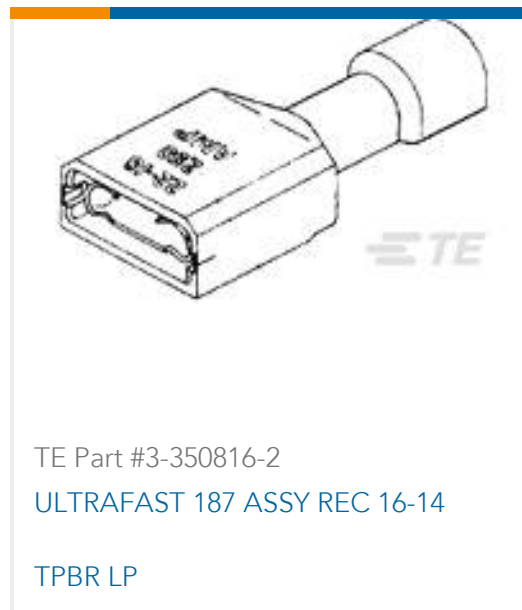

Documents

Product Drawings

[RECEPT, FASTON SPLICE 22-10](#)

English

CAD Files

[3D PDF](#)

English

Customer View Model

[ENG_CVM_8-321235-1_U3.3d_igs.zip](#)

English

Customer View Model

[ENG_CVM_8-321235-1_U3.3d_stp.zip](#)

English

Customer View Model

[ENG_CVM_8-321235-1_U3.2d_dxf.zip](#)

English

[3D PDF](#)

3D

Customer View Model

[ENG_CVM_CVM_8-321235-1_T.2d_dxf.zip](#)

English

Customer View Model

[ENG_CVM_CVM_8-321235-1_T.3d_igs.zip](#)

English

Customer View Model

[ENG_CVM_CVM_8-321235-1_T.3d_stp.zip](#)

English

By downloading the CAD file I accept and agree to the [Terms and Conditions](#) of use.

Agency Approvals

[Agency Approval Document](#)

English