

PLEASE CHECK WWW.MOLEX.COM FOR LATEST PART INFORMATION

Part Number: **0780470873**
Status: **Active**
Overview: Pico-SPOX Wire-to-Board Connector System
Description: Pico-SPOX Wire-to-Board Header, 1.50mm Pitch, Surface Mount, Vertical, Tin (Sn) Plating, with Cap, Liquid Crystal Polymer, 8 Circuits, Beige, Tape and Reel

Documents:

3D Model	Product Specification PS-78047-001-001 (PDF)
3D Model (PDF)	Packaging Specification 780479200-200 (PDF)
Drawing (PDF)	RoHS Certificate of Compliance (PDF)

General

Product Family	PCB Headers
Series	78047
Application	Signal, Wire-to-Board
Overview	<u>Pico-SPOX Wire-to-Board Connector System</u>
Product Name	Pico-SPOX
UPC	883906180522

Physical

Breakaway	No
Circuits (Loaded)	8
Circuits (maximum)	8
Color - Resin	Beige
Durability (mating cycles max)	10
First Mate / Last Break	No
Glow-Wire Capable	No
Guide to Mating Part	No
Keying to Mating Part	None
Lock to Mating Part	Yes
Material - Metal	Brass
Material - Plating Mating	Tin
Material - Plating Termination	Tin
Material - Resin	Liquid Crystal Polymer
Net Weight	432.920/mg
Number of Rows	1
Orientation	Vertical
PCB Locator	No
PCB Retention	None
Packaging Type	Embossed Tape on Reel
Pitch - Mating Interface	1.50mm
Plating min - Mating	2.540µm
Plating min - Termination	2.540µm
Polarized to Mating Part	Yes
Polarized to PCB	No
Robotic Placement	Pick and Place Cap
Shrouded	Fully
Stackable	No
Temperature Range - Operating	-55° to +105°C
Termination Interface: Style	Surface Mount

Electrical

Current - Maximum per Contact	2.5A
Voltage - Maximum	250V AC

Material Info

Reference - Drawing Numbers

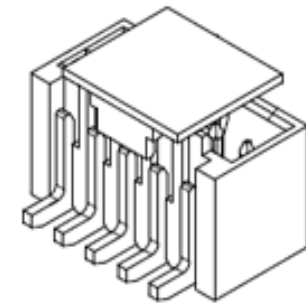

Series image - Reference only

EU ELV

Not Relevant

EU RoHS

Compliant

REACH SVHC

Not Contained Per -
D(2020)4578-DC (25
June 2020)

Halogen-Free

Status

Not Low-Halogen

For more information, please visit [Contact US](#)

China ROHS

ELV

RoHS Phthalates

China RoHS

Green Image

Not Relevant

Not Contained

Search Parts in this Series

[78047 Series](#)

Mates With

Pico-SPOX Wire-to-Board Housing [87439](#)

Packaging Specification
Product Specification
Sales Drawing

780479200-200
PS-78047-001-001
SD-78047-001

This document was generated on 10/07/2020

PLEASE CHECK WWW.MOLEX.COM FOR LATEST PART INFORMATION