

Data Sheet | Item Number: 770-115

Plug; with strain relief housing; 5-pole; Cod. A; 4,00 mm²; black

<https://www.wago.com/770-115>



Color: ■ black

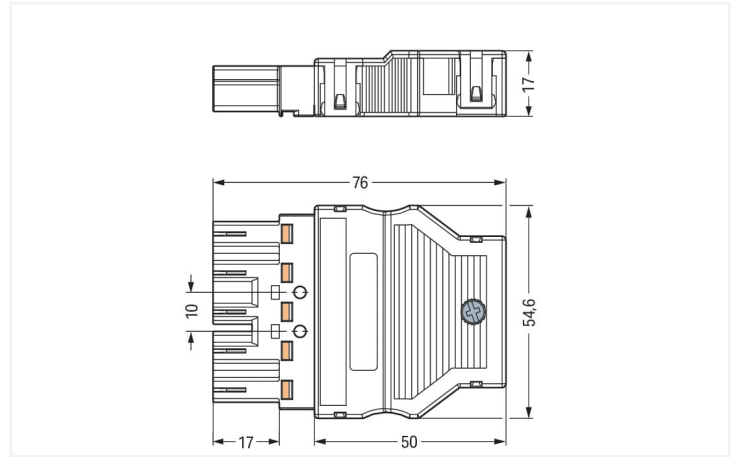

Dimensions in mm

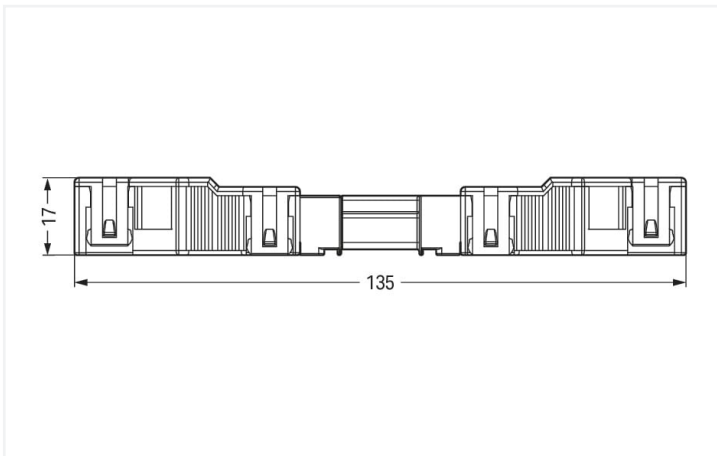

Dimensions in mm

Overall length when mated

Male connector/plug WINSTA® MIDI with strain relief

Use effective pluggable connections instead of laborious screw connections: With the WINSTA® MIDI male connector/plug with protection against mismatching. WAGO pluggable installation connectors are used when criteria repeat or are planned on a defined grid, for example for installing grid lighting or flush-mount lighting. The color coding and mechanical coding of the pluggable installation connector ensure error-free installation of the individual components – including protection against mismatching. The pluggable installation connector is protected against ingress by solid objects in accordance with protection type IP20 (When mated and secured with a strain relief housing: IP2xC (These compact connectors are not designed for use in open, easily accessible areas!)). The WINSTA® MIDI pluggable installation connector with A coding in black or white is usually used for general mains applications in power distribution. This pluggable installation connector is used for electrical currents up to 25 A. Thus the product is ideally suitable for high power loads. The WINSTA® MIDI product line achieves maximum flexibility for the installation. Through its Push-in CAGE CLAMP® spring pressure connection technology, it guarantees error-free, time-saving installation and offers flexibility for meeting various installation requirements. The strip length is 55 mm.

Push-in CAGE CLAMP® spring pressure connection technology – pluggable installation instead of laborious screw connections!

The WINSTA® Pluggable Connection System is perfectly tailored to the strict requirements of building installation. It makes electrical installation pluggable, and thus more efficient, even more reliable, and error-free. Using this pre-assembled system decreases time spent on assembly and installation errors at the construction site. Enjoy the benefits of the pluggable version of our maintenance-free spring pressure connection technology tool! Plan your installation with with marking from WAGO.

- protection against mismatching eliminates errors
- pre-assembled versions
- with A coding for use in many general mains applications
- custom-engineered solutions
- convenient installation and commissioning

This item includes:



Item No.: 770-505

1

Item No.: 770-215

1

Strain relief housing; 5-pole; for 2 cables;
9.0 ... 13.0 mm; 55 mm; blackPlug; 5-pole; Cod. A; 4,00 mm²; black

Electrical data

Ratings per	IEC/EN 60664-1			Approvals per	UL 1977
Overtoltage category	III	III	II	Rated voltage	600 V
Pollution degree	3	2	2	Rated current	23 A
Nominal voltage	400 V	-	-		
Rated surge voltage	6 kV	-	-		
Rated current	25 A	-	-		

General information

Note on contact resistance	approx. 1 mΩ of contact resistance approx. 0.25 mΩ contact transition plug/ socket
----------------------------	--

Connection data

Clamping units	10	Connection 1	
Total number of potentials	5	Connection technology	Push-in CAGE CLAMP®
PE function	Preceding PE contact	Actuation type	Operating tool Push-in
		Nominal cross-section	4 mm ² / 12 AWG
		Solid conductor	0.5 ... 4 mm ² / 20 ... 12 AWG
		Solid conductor; push-in termination	1.5 ... 4 mm ² / 16 ... 12 AWG
		Stranded conductor	0.5 ... 2.5 mm ² / 20 ... 14 AWG
		Fine-stranded conductor	0.5 ... 4 mm ² / 20 ... 12 AWG
		Fine-stranded conductor; with insulated ferrule	0.25 ... 1.5 mm ² / 20 ... 16 AWG
		Fine-stranded conductor; with uninsulated ferrule	0.25 ... 2.5 mm ² / 20 ... 14 AWG
		Fine-stranded conductor; with ferrule; push-in termination	1.5 mm ² / 16 AWG
		Strip length	9 mm / 0.35 inches
		Pole number	5
		Connectable sheathed cable diameter	9 ... 13 mm
		Conductor entry direction to mating direction	0°
		Strip length (outer insulation)	55 mm

Physical data

Pin spacing	10 mm / 0.394 inches
Width	54.6 mm / 2.15 inches
Height	17 mm / 0.669 inches
Depth	76 mm / 2.992 inches

Mechanical data

Use	General mains applications
Coding	A
Variable coding	Yes
Marking	L3 L2 L1 N
Potential marking	L3 L2 L1 N
Mating force of a plug-in connection	approx. 20 ... 70 N (depending on pole number)
Retention force of a plug-in connection	Locked: > 80 N
Unmating force of a plug-in connection	Unlocked: approx. 20 ... 70 N (depending on pole number)
Number of mating cycles	200, without resistive load
Protection type	IP20; When mated and secured with a strain relief housing: IP2xC (These compact connectors are not designed for use in open, easily accessible areas!)

Plug-in connection

Contact type (pluggable connector)	Male connector/plug
Connector (connection type)	for conductor
Mismating protection	Yes
Note on mismating protection	All WINSTA® components are 100% protected against mismating when: a.) plugging different numbers of poles b.) plugging while rotated 180 c.) plugging while laterally staggered d.) plugging one pole
Locking lever	Can be retrofitted
Locking of plug-in connection	Locking lever
Note on locking system	All connectors for mounted installations (snap-in versions for lighting fixtures or devices, all types of PCB and distribution connectors) are factory-equipped with locking levers to ensure plugs and sockets are securely locked. Additional locking levers are only required for flying leads (plug/socket).
Strain relief	Strain relief housing

Material data

Note (material data)	Information on material specifications can be found here
Color	black
Cover color	gray
Material group	I
Insulation material (main housing)	Polyamide (PA66)
Flammability class per UL94	V0
Clamping spring material	Chrome-nickel spring steel (CrNi)
Contact material	Copper or copper alloy; surface-treated
Contact Plating	Tin
Fire load	0.814 MJ
Connector color	black
Strain relief color	black
Weight	29.7 g

Environmental requirements

Processing temperature	-5 ... +40 °C
Continuous operating temperature	-35 ... +85 °C
Note on continuous operating temperature	Insulating parts for temperatures ≤ 105 °C

Commercial data	
Product Group	20 (Winsta)
eCl@ss 10.0	27-44-06-05
eCl@ss 9.0	27-44-06-05
ETIM 9.0	EC002560
ETIM 8.0	EC002560
PU (SPU)	25 pcs
Packaging type	Box
Country of origin	DE
GTIN	4044918254441
Customs tariff number	85366990990

Environmental Product Compliance	
RoHS Compliance Status	Compliant, No Exemption

Approvals / Certificates

General approvals			Declarations of conformity and manufacturer's declarations								
			<table border="1"> <thead> <tr> <th>Approval</th> <th>Standard</th> <th>Certificate Name</th> </tr> </thead> <tbody> <tr> <td>EU-Declaration of Conformity WAGO GmbH & Co. KG</td> <td>-</td> <td>-</td> </tr> </tbody> </table>			Approval	Standard	Certificate Name	EU-Declaration of Conformity WAGO GmbH & Co. KG	-	-
Approval	Standard	Certificate Name									
EU-Declaration of Conformity WAGO GmbH & Co. KG	-	-									
Approval	Standard	Certificate Name									
CCA DEKRA Certification B.V.	EN 61535	71-123228									
CCA DEKRA Certification B.V.	IEC 61535	NL -84761									
cURus Underwriters Laboratories Inc.	UL 1977	E45171									
cURus Underwriters Laboratories Inc.	UL 1059	E 45172									
VDE VDE Prüf- und Zertifizierungsinstitut	EN 61984	40002889									
VDE VDE Prüf- und Zertifizierungsinstitut	EN 61535	40029808									

Approvals for marine applications		
Approval	Standard	Certificate Name
ABS American Bureau of Shipping	-	19-HG1868589-PDA
DNV GL Det Norske Veritas, Germanischer Lloyd	-	TAE00001Z6
LR Lloyds Register	IEC 61984	LR22429487TA

Downloads

Environmental Product Compliance

Compliance Search

Environmental Product Compliance 770-115



Documentation

Bid Text

770-115	19.02.2019	xml 3.01 KB	
770-115	08.06.2015	doc 23.50 KB	
ausschreiben.de 770-115			

CAD/CAE-Data

CAD data

2D/3D Models 770-115



CAE data

EPLAN Data Portal
770-115



WSCAD Universe
770-115



ZUKEN Portal 770-115



1 Compatible Products

1.1 System counterpart

1.1.1 Cable assembly



Item No.: 771-9995/106-101

pre-assembled connecting cable; Eca; Socket/open-ended; 5-pole; Cod. A; H05VV-F 5G 1.5 mm²; 1 m; 1,50 mm²; black

Item No.: 771-9995/006-101

pre-assembled interconnecting cable; Eca; Socket/plug; 5-pole; Cod. A; H05VV-F 5G 1.5 mm²; 1 m; 1,50 mm²; black

1.1.2 Distribution box



Item No.: 899-681/147-000

Distribution box; 400 V + DALI; 2 inputs; 5 outputs; Cod. A, I; MINI, MIDI; white



Item No.: 899-631/187-000

Distribution box; Three-phase current (400 V); 1 input; 5 outputs; Cod. A; MIDI; black



Item No.: 899-631/346-000

Distribution box; Three-phase to single-phase current (400 V/230 V); 1 input; 4 outputs; Cod. A; MIDI; black



Item No.: 899-631/100-000

Distribution box; Three-phase to single-phase current (400 V/230 V); 1 input; 7 outputs; Cod. A; MIDI; black

1.1.3 Distribution connector



Item No.: 770-609

3-way distribution connector; 5-pole; Cod. A; 1 input; 3 outputs; black



Item No.: 770-659

3-way distribution connector; 5-pole; Cod. A; 1 input; 3 outputs; white



Item No.: 770-621

T-distribution connector; 5-pole; Cod. A; 1 input; 2 outputs; 2 locking levers; black



Item No.: 770-622

T-distribution connector; 5-pole; Cod. A; 1 input; 2 outputs; 3 locking levers; for flying leads; black



Item No.: 770-611

Three-phase to single-phase distribution connector; with phase selection; 5-pole/3-pole; Cod. A; 1 input; 2 outputs; with cable connection on the input side; black



Item No.: 770-640

Three-phase to single-phase distribution connector; with phase selection; 5-pole/3-pole; Cod. A; 1 input; 5 outputs; black

1.1.4 Female connector/socket



Item No.: 770-705

Snap-in socket; 5-pole; Cod. A; 4,00 mm²; black



Item No.: 770-705/009-000

Snap-in socket; with protruding mating face; 5-pole; Cod. A; 4,00 mm²; black



Item No.: 770-805/011-000

Socket for PCBs; angled; 5-pole; Cod. A; black



Item No.: 770-805

Socket for PCBs; straight; 5-pole; Cod. A; black



Item No.: 770-205

Socket; 5-pole; Cod. A; 4,00 mm²; black



Item No.: 770-405

Socket; 5-pole; Cod. A; 4,00 mm²; black



Item No.: 770-105

Socket; with strain relief housing; 5-pole; Cod. A; 4,00 mm²; black



Item No.: 770-305

Socket; with strain relief housing; 5-pole; Cod. A; 4,00 mm²; black

1.1.5 Tap-off module



Item No.: 772-262

Tap-off module; for flat cable; 5 x 2.5 mm² + 2 x 1.5 mm²; 5-pole; Cod. A; with cable connection on the output side; black

1.2 Required Accessories

1.2.1 Locking system

1.2.1.1 Locking system



Item No.: 770-101

Locking lever; for flying leads; for manual operation; black



Item No.: 770-121

Locking lever; for flying leads; for manual operation; white



Item No.: 770-111

Locking lever; for flying leads; for tool operation; black



Item No.: 770-131

Locking lever; for flying leads; for tool operation; white

1.3 Optional Accessories

1.3.1 Coding

1.3.1.1 Coding



[Item No.: 770-401](#)

Coding pin; for plugs; Plastic; gray

1.3.2 Cover

1.3.2.1 Cover



[Item No.: 770-360](#)

Lockout cap; for plugs; 5-pole; separable; yellow



[Item No.: 897-2005](#)

Protective cap; Type4; for sockets and plugs; PVC; red

1.3.3 Marking

1.3.3.1 Marker



[Item No.: 770-450/000-006](#)

Marker card; Plastic; blue



[Item No.: 770-450/000-001](#)

Marker card; Plastic; green



[Item No.: 770-450/000-012](#)

Marker card; Plastic; orange



[Item No.: 770-450/000-005](#)

Marker card; Plastic; red



[Item No.: 770-450](#)

Marker card; Plastic; white



[Item No.: 770-450/000-002](#)

Marker card; Plastic; yellow

1.3.4 Tool

1.3.4.1 Operating tool



[Item No.: 210-719](#)

Operating tool; Blade: 2.5 x 0.4 mm; with a partially insulated shaft

1.3.4.2 Wiring aid



[Item No.: 770-100](#)

Wiring aid; 2- to 5-pole; Plastic; orange

Installation Notes

Conductor termination



1. Strip length, outer insulation = 35 mm (2-pole), 55 mm (3- to 5-pole)
2. Strip length = 9 mm
3. Extended ground conductor = 8 mm

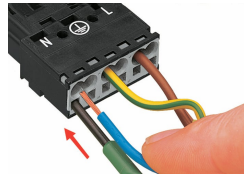

To terminate fine-stranded conductors, open the clamping unit via screwdriver (2.5 mm blade width) and insert a stripped conductor until it hits the backstop.



Insert the stripped solid conductor until it hits the backstop.

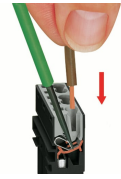

To terminate fine-stranded conductors, open the clamping unit via screwdriver (2.5 mm blade width) and insert a stripped conductor until it hits the backstop.

Conductor removal

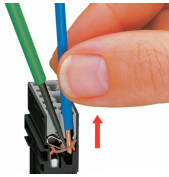

To remove the conductor, actuate the clamp via screwdriver (2.5 mm blade width) and pull out the conductor.

Installation

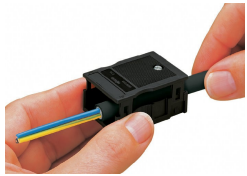

We recommend pulling the pre-latched strain relief housing over the cable prior to termination. However, the strain relief can be mounted at a later time as well.

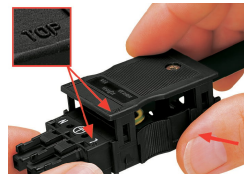

Latch the strain relief housing onto the plug/socket. Note the "TOP" inscription.

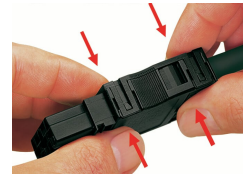

Prepare strain relief housing by snapping together upper and bottom part.



Tighten strain relief screw with screwdriver (2.5 mm blade width).