

Product description **Contacts: 8, M12 cordset A-coded male to male**  
**2m shielded Ethernet TPE Black**  
 Area **M12-A Series 763**  
 Order number **77 3529 3529 64708-0200**

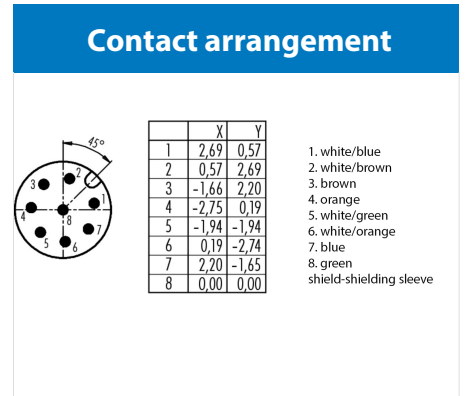
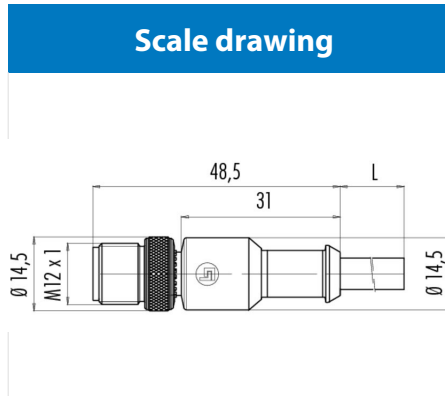

## Technical data

### General values

Connector design cable connector  
 Connector locking system bolted  
 Termination moulded on cable  
 Wire gauge (mm) 0,25 mm<sup>2</sup>  
 Wire gauge (AWG) (24)  
 Upper limit temperature 90 °C  
 Lower limit temperature -25 °C

### Cable data

Sheath material TPE  
 Single-lead insulation HDPE  
 Single-lead structure 7 x 32  
 Cable diameter 6  
 Conductor resistance <79Ω/Km  
 Temperature range, moving cable, °C from -40  
 Temperature range, moving cable, °C to 80  
 Temperature range, fixed cable, °C from -40  
 Temperature range, fixed cable, °C to 80  
 Bending radius, fixed cable min. 10 x D  
 Bending radius, moving cable min. 20 x D  
 Approval 1 UL listed

### Electrical values

Rated current (40 °C) 2 A  
 Rated voltage 30 V  
 Rated impulse voltage 800 V  
 Pollution degree 3  
 Overvoltage category II  
 Insulating material group II  
 Volume resistivity ≤ 3 mΩ  
 Insulation resistance ≥ 10<sup>10</sup>Ω  
 EMC compliance not shielded  
 Degree of protection IP68  
 Mechanical operation > 100 Mating cycles

### Material

Contact material CuZn (brass)  
 Contact plating Au (gold)  
 Contact body material PUR  
 Housing material PUR

Product description	<b>Contacts: 8, M12 cordset A-coded male to male 2m shielded Ethernet TPE Black</b>
Area	
Order number	<b>M12-A Series 763 77 3529 3529 64708-0200</b>

## Security notices

The connectors are designed for use in plant, control system and electrical equipment. The end user is responsible for checking whether the connectors are suitable for use in other applications.

Connectors with degree of protection IP 67 and IP 68 are not suitable for use under water. When used outdoors, the connectors must be separately protected against corrosion. For further information about IP degrees of protection refer to 'Technical support' in the Download Centre.

To lock the cable connector to the equipment connector, the threaded ring is tightened until it is 'finger-tight' (approx. 50 cNm).