

Product description **Contacts: 8, M12 cordset 8p A-coded male to male straight**
2m shielded Ethernet TPE
 Area **M12-A Series 763**
 Order number **77 3529 3529 34708-0200**

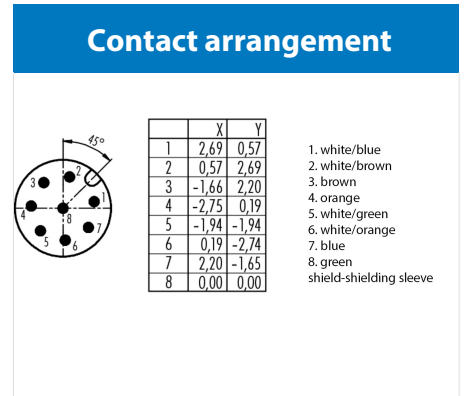
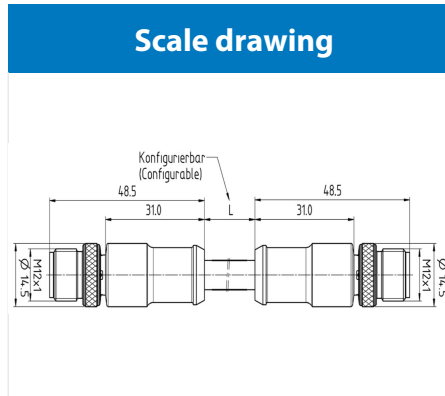

Technical data

General values

Connector design cable connector
 Connector locking system bolted
 Termination moulded on cable
 Wire gauge (mm) 0,25 mm²
 Wire gauge (AWG) (24)
 Upper limit temperature 90 °C
 Lower limit temperature -25 °C

Cable data

Sheath material TPE
 Single-lead insulation HDPE
 Single-lead structure 7 x 32
 Cable diameter 6
 Conductor resistance <79Ω/Km
 Temperature range, moving cable, °C from -40
 Temperature range, moving cable, °C to 80
 Temperature range, fixed cable, °C from -40
 Temperature range, fixed cable, °C to 80
 Bending radius, fixed cable min. 10 x D
 Bending radius, moving cable min. 20 x D
 Approval 1 UL listed

Electrical values

Rated current (40 °C) 2 A
 Rated voltage 30 V
 Rated impulse voltage 800 V
 Pollution degree 3
 Overvoltage category II
 Insulating material group II
 Volume resistivity ≤ 3 mΩ
 Insulation resistance ≥ 10¹⁰Ω
 EMC compliance not shielded
 Degree of protection IP68
 Mechanical operation > 100 Mating cycles

Material

Contact material CuZn (brass)
 Contact plating Au (gold)
 Contact body material PUR
 Housing material PUR

Product description	Contacts: 8, M12 cordset 8p A-coded male to male straight 2m shielded Ethernet TPE
Area	M12-A Series 763
Order number	77 3529 3529 34708-0200

Security notices

The connectors are designed for use in plant, control system and electrical equipment. The end user is responsible for checking whether the connectors are suitable for use in other applications.

Connectors with degree of protection IP 67 and IP 68 are not suitable for use under water. When used outdoors, the connectors must be separately protected against corrosion. For further information about IP degrees of protection refer to 'Technical support' in the Download Centre.

To lock the cable connector to the equipment connector, the threaded ring is tightened until it is 'finger-tight' (approx. 50 cNm).