

R76UI0820DQ00J

aka 76UI0820DQ00J

Capacitor, film, 820 pF, +/-5% Tol, -55/+105C, Pulse, 2000V@85C,
Lead Spacing=15 mm

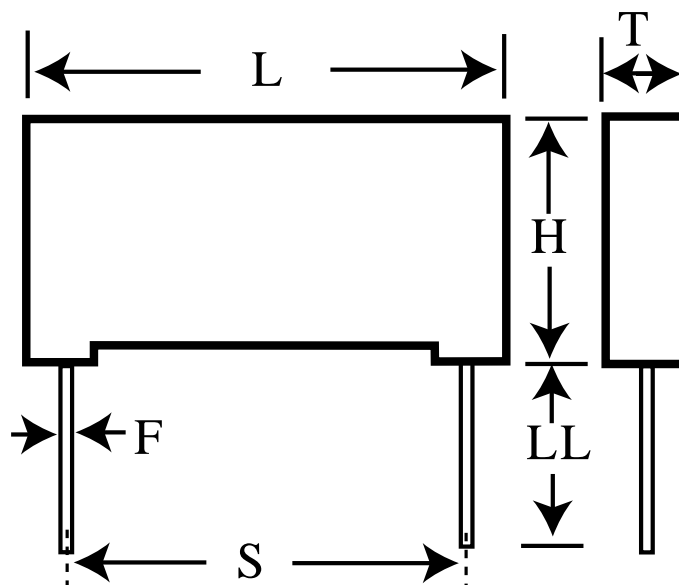

Dimensions (mm)

Specifications

ID	Dimension	Tolerance	Manufacturer:	KEMET
L	18	+0.3	Brand:	Arcotronics
H	11	+0.1	Capacitance:	820 pF
T	5	+0.2	Temperature Range:	-55/+105C
S	15	+/-0.4	Rated Temperature:	85C
LL	18.5	+/-0.5	Voltage @ rated temp:	2000V
F	0.8	+/-0.05	Voltage AC:	700VAC
			Tolerance:	+/-5%
			Body Type:	Radial Box
			Construction:	Double Metallized
			Application:	Pulse
			Dielectric:	Metallized Polypropylene
			Dissipation Factor @ 1 kHz:	0.03%
			Dissipation Factor @ 10 kHz:	0.04%
			Dissipation Factor @ 100kHz:	0.15%
			Insulation Resistance:	100 GOhm
			Inductance:	10 nH
			Maximum dVdT:	9500v/us
			Maximum K0:	38000000V^2/us
			Package Kind:	Ammo
			Package Type:	Box
			Package Quantity:	800