

PLEASE CHECK WWW.MOLEX.COM FOR LATEST PART INFORMATION

Part Number: [76165-9605](#)
Status: **Active**
Overview: Impact™ Backplane Connectors and Cable Assemblies
Description: Impact™ 100 Ohm 3 Pair Vertical Backplane Header, 1.90 by 1.35mm Pitch, Right Guide, Left Endwall, 16 Columns, 144 Circuits, Pin Length 5.50mm, Plated Through Hole Dimension 0.46mm, Lead-Free

Documents:

[3D Model](#) [Application Specification AS-76060-990 \(PDF\)](#)
[Drawing \(PDF\)](#) [RoHS Certificate of Compliance \(PDF\)](#)
[Product Specification PS-76060-999 \(PDF\)](#)

Agency Certification

UL E29179

General

Product Family Backplane Connectors
 Series [76165](#)
 Application Conventional
 Application Tooling Documents TM-622018799
 Component Type PCB Header
 Overview [Impact™ Backplane Connectors and Cable Assemblies](#)
 Product Name Impact™
 Style N/A
 UPC 883906225971

Physical

Circuits (Loaded) 144
 Circuits (maximum) 144
 Color - Resin Black
 Durability (mating cycles max) 200
 First Mate / Last Break No
 Flammability 94V-0
 Guide to Mating Part Yes
 Keying to Mating Part None
 Material - Metal High Performance Alloy (HPA)
 Material - Plating Mating Gold
 Material - Plating Termination Tin
 Material - Resin High Temperature Thermoplastic
 Net Weight 6.542/g
 Number of Columns 16
 Number of Pairs 3
 Number of Rows 9
 Orientation Vertical
 PC Tail Length 1.40mm
 PCB Locator No
 PCB Retention None
 PCB Thickness - Recommended 1.00mm
 Packaging Type Tray
 Pitch - Mating Interface 1.90mm
 Pitch - Termination Interface 1.90mm
 Plating min - Mating 0.762µm
 Polarized to PCB Yes
 Stackable Yes
 Temperature Range - Operating -55°C to +85°C
 Termination Interface: Style Through Hole - Compliant Pin

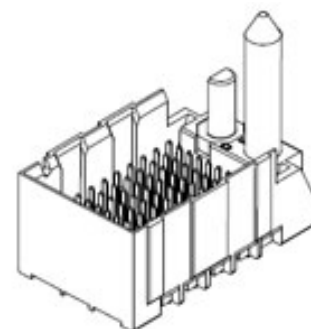

image - Reference only

Series

EU RoHS

ELV and RoHS Compliant

REACH SVHC

Not Reviewed

Low-Halogen Status

Low-Halogen

China RoHS



Need more information on product environmental compliance?

Email productcompliance@molex.com
 For a multiple part number RoHS Certificate of Compliance, [click here](#)

Please visit the [Contact Us](#) section for any non-product compliance questions.

Search Parts in this Series

[76165Series](#)

Mates With

[76170 Impact™ 100 Ohm Daughtercard](#)

Application Tooling | FAQ

Tooling specifications and manuals are found by selecting the products below. Crimp Height Specifications are then contained in the Application Tooling Specification document.

Global

Description	Product #
Backplane Header Removal Tool for GbX-U™, I-Trac™, Impact™, or TinMan	0621009610
Backplane Module Installation, Press-In Tool	0622018651
Backplane Insertion Tool for Signal Contact	0621005800

Electrical

Current - Maximum per Contact	0.75A
Data Rate	25.0 Gbps
Impedance	100#
Shield Type	N/A
Shielded	No
Voltage - Maximum	30V AC (RMS)/DC

Material Info**Reference - Drawing Numbers**

Application Specification	AS-76060-990
Product Specification	PS-76060-999
Sales Drawing	SD-76155-003, SD-76165-003
Symbol/Footprint Data	SYM-76165-9605

This document was generated on 05/13/2013

PLEASE CHECK WWW.MOLEX.COM FOR LATEST PART INFORMATION