

**Data Sheet | Item Number: 750-466**  
**2-channel analog input; 4 ... 20 mA; Single-ended**

<https://www.wago.com/750-466>

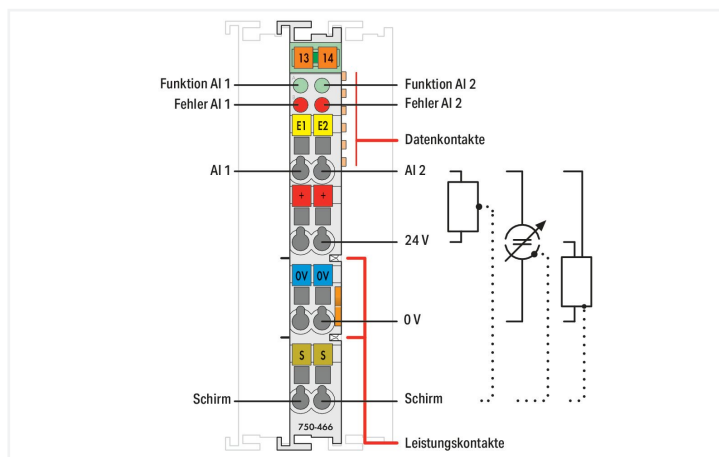

Color: ■ light gray

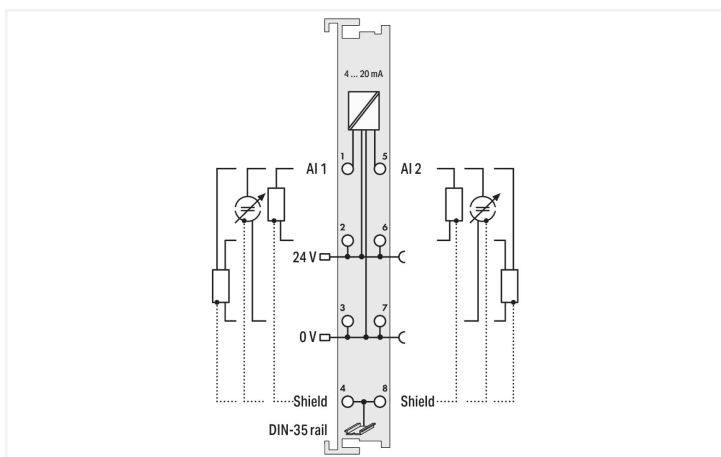
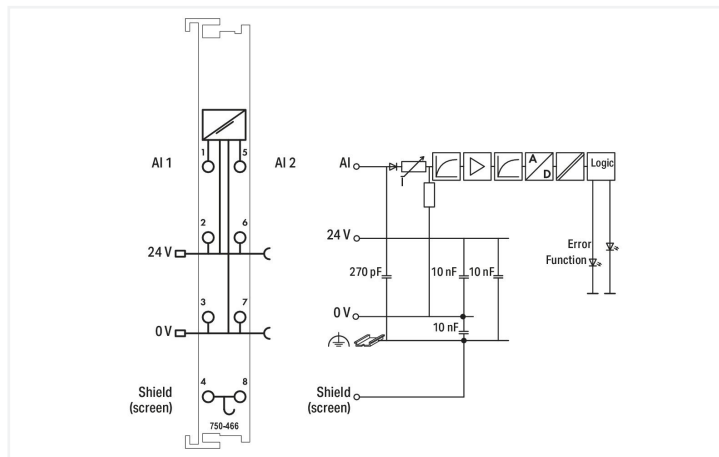

This analog input module powers field-side signal conditioners and transmits electrically isolated analog signals to the bus system. The 24 V field supply is derived from the module's power jumper contacts. The shield directly connects to the DIN-rail. This module powers 2-wire signal conditioners without dedicated power supply.

Technical data	
Number of analog inputs	2
Total number of channels (module)	2
Signal type	Current
Signal type (current)	4 ... 20 mADC
Sensor connection	2 x (2-wire, 3-wire)
Input voltage (max.)	10 V
Signal characteristics	Single-ended
Resolution [bit]	12 bits
Input resistance (max.)	220 Ω
Data width	2 x 16-bit data; 2 x 8-bit control/status (optional)
Conversion time (typ.)	2 ms
Measurement error (reference temperature)	25 °C
Measurement error, deviation (max.) from the upper-range value	0.2 %
Temperature error (max.) of the upper-range value	0.01 %/K
Supply voltage (system)	5 VDC; via data contacts
Current consumption (5 V system supply)	75 mA
Supply voltage (field)	24 VDC (-25 ... +30 %); via power jumper contacts (power supply via blade contact; transmission (supply voltage field side only) via spring contact)
Isolation	500 V system/field

### Technical data

Indicators	LED (A, C) green: Function AI 1, AI 2; LED (B, D) red: Error AI 1, AI 2
Number of incoming power jumper contacts	2
Number of outgoing power jumper contacts	2

### Connection data

Connection technology: inputs/outputs	8 x CAGE CLAMP®
Connection type 1	Inputs/outputs
Solid conductor	0.08 ... 2.5 mm <sup>2</sup> / 28 ... 14 AWG
Fine-stranded conductor	0.08 ... 2.5 mm <sup>2</sup> / 28 ... 14 AWG
Strip length	8 ... 9 mm / 0.31 ... 0.35 inches

### Physical data

Width	12 mm / 0.472 inches
Height	100 mm / 3.937 inches
Depth	69.8 mm / 2.748 inches
Depth from upper-edge of DIN-rail	62.6 mm / 2.465 inches

### Mechanical data

Mounting type	DIN-35 rail
---------------	-------------

### Material data

Color	light gray
Housing material	Polycarbonate; polyamide 6.6
Fire load	1.037 MJ
Weight	49.9 g
Conformity marking	CE

### Environmental requirements

Ambient temperature (operation)	0 ... +55 °C
Ambient temperature (storage)	-40 ... +85 °C
Protection type	IP20
Pollution degree	2 per IEC 61131-2
Operating altitude	0 ... 2000 m / 0 ... 6562 ft
Mounting position	Horizontal left, horizontal right, horizontal up, horizontal down, vertical top and vertical bottom
Relative humidity (without condensation)	95 %
Vibration resistance	per IEC 60068-2-6
Shock resistance	15g per IEC 60068-2-27
EMC immunity to interference	per EN 61000-6-2
EMC emission of interference	per EN 61000-6-4
Exposure to pollutants	per IEC 60068-2-42 and IEC 60068-2-43
Permissible H <sub>2</sub> S contaminant concentration at a relative humidity 75 %	10 ppm
Permissible SO <sub>2</sub> contaminant concentration at a relative humidity 75 %	25 ppm

### Commercial data

Product Group	15 (I/O System)
eCl@ss 10.0	27-24-26-01
eCl@ss 9.0	27-24-26-01
ETIM 9.0	EC001596
ETIM 8.0	EC001596
PU (SPU)	1 pcs
Packaging type	Box
Country of origin	DE
GTIN	4045454392949
Customs tariff number	85389099990

### Environmental Product Compliance

CAS-No.	1303-86-2 1317-36-8 7439-92-1
REACH Candidate List Substance	Diboron trioxide Lead Lead monoxide
RoHS Compliance Status	Compliant,With Exemption
RoHS Exemption	6(c) 7(a) 7(c)-I 7(c)-II
SCIP notification number (Austria)	448233da-0cfd-4410-844a-035cbd6bd610
SCIP notification number (Belgium)	52e127be-5791-47a6-8020-c23f994ec05c
SCIP notification number (Bulgaria)	dba44114-8852-4acc-986d-1d9ac0b8cba0
SCIP notification number (Czech Republic)	2d537bdf-5163-4618-b110-c240649fc2a9
SCIP notification number (Denmark)	34958418-b19d-459c-b740-b0a24747702d
SCIP notification number (Finland)	50d90c88-4ea7-45f1-8e18-dd32e9f430e3
SCIP notification number (France)	a6fffb0c-ab8c-46bf-b023-6cdd572abf5c
SCIP notification number (Germany)	c7035a35-bcf1-4c22-9e63-e11c122a59c5
SCIP notification number (Hungary)	ce286eb7-13c0-4297-96bf-a559348e7617
SCIP notification number (Italy)	aa9f9b98-e9b1-4a80-bd4e-e3ca07d666e8
SCIP notification number (Netherlands)	b981cfa1-6233-4bb9-bc02-5b1e09349429
SCIP notification number (Poland)	f7a0a260-a9a0-4a39-9b79-076da4f45a37
SCIP notification number (Romania)	d2a44cb0-eb95-44ae-a241-b4fe991432cc
SCIP notification number (Sweden)	92b73b78-80cf-4254-91ee-348468001171

### Approvals / Certificates

#### General approvals



Approval	Standard	Certificate Name
EAC GZO Almaty Standart	TP TC 020/2011	EAC CoC 03083
KC National Radio Research Agency	Article 58-2, Clause 3	MSIP-REM-W43-AIM750
UL Underwriters Laboratories Inc. (ORDINARY LOCATIONS)	UL 508	E175199

#### Declarations of conformity and manufacturer's declarations

Approval	Standard	Certificate Name
EU-Declaration of Conformity WAGO GmbH & Co. KG	-	-
UK-Declaration of Conformity WAGO GmbH & Co. KG	-	-

Approvals for hazardous areas



Approval	Standard	Certificate Name
ATEX TUEV Nord Cert GmbH	EN 60079-0	TUEV14ATEX148929X (II 3 G Ex ec IIC T4 Gc)
CCCEX CQST/CNEC	CNCA-C23-01	2020312310000213 (Ex ec IIC T4 Gc)
IECEX TUEV Nord Cert GmbH	IEC 60079-0	IECEX TUN 14.0035 X (Ex ec IIC T4 Gc)
INMETRO TUV Rheinland do Brasil Ltda.	IEC 60079-0	TUV 12.1297 X
KTL Korea Testing Laboratory	KOSHA Article 34, IEC60079-0	21-KA4BO-0550X
UKEx WAGO GmbH & Co. KG	EN 60079-0	UKCA_WA GO22UKEX003X_ec
UL Underwriters Laboratories Inc. (HAZARDOUS LOCATIONS)	UL 121201	E198726

Downloads

Environmental Product Compliance

Compliance Search
Environmental Product Compliance 750-466 <a href="#">↓</a>

Documentation

Manual			
Product Manual 4-20mA, single-ended	V 1.4.0	pdf 1997.81 KB	<a href="#">↓</a>
System Manual Series 750/753			<a href="#">↓</a>

System Description		
750/753 Series I/O-System – General Product Information	pdf 953.35 KB	<a href="#">↓</a>
Overview on WAGO-I/O-SYSTEM 750 approvals	pdf 770.48 KB	<a href="#">↓</a>

Bid Text			
750-466	19.02.2019	xml 4.32 KB	<a href="#">↓</a>
750-466	17.10.2017	doc 29.00 KB	<a href="#">↓</a>

Instruction Leaflet			
CCC Ex (Additional information)	26.04.2023	pdf 159.76 KB	<a href="#">↓</a>

**CAD/CAE-Data**

CAD data	CAE data
2D/3D Models 750-466	EPLAN Data Portal 750-466
	WSCAD Universe 750-466
	ZUKEN Portal 750-466

**Device Files**

Device Driver			
WAGO USB Service Kabel Treiber / Serie 750 und 857	6.5.3.0 10.09.2014	zip 4721.96 KB	

**1 Compatible Products**

**1.1 Optional Accessories**

**1.1.1 DIN-rail**

**1.1.1.1 Mounting accessories**











<p><b>Item No.: 210-196</b> Aluminum carrier rail; 35 x 8.2 mm; 1.6 mm thick; 2 m long; unslotted; similar to EN 60715; silver-colored</p>	<p><b>Item No.: 210-198</b> Copper carrier rail; 35 x 15 mm; 2.3 mm thick; 2 m long; unslotted; according to EN 60715; copper-colored</p>	<p><b>Item No.: 210-508</b> Steel carrier rail; 35 x 15 mm; 1.5 mm thick; 2 m long; slotted; galvanized; similar to EN 60715; silver-colored</p>	<p><b>Item No.: 210-197</b> Steel carrier rail; 35 x 15 mm; 1.5 mm thick; 2 m long; slotted; similar to EN 60715; silver-colored</p>
<p><b>Item No.: 210-506</b> Steel carrier rail; 35 x 15 mm; 1.5 mm thick; 2 m long; unslotted; galvanized; similar to EN 60715; silver-colored</p>	<p><b>Item No.: 210-114</b> Steel carrier rail; 35 x 15 mm; 1.5 mm thick; 2 m long; unslotted; similar to EN 60715; silver-colored</p>	<p><b>Item No.: 210-118</b> Steel carrier rail; 35 x 15 mm; 2.3 mm thick; 2 m long; unslotted; according to EN 60715; silver-colored</p>	<p><b>Item No.: 210-115</b> Steel carrier rail; 35 x 7.5 mm; 1 mm thick; 2 m long; slotted; according to EN 60715; "Hole width 18 mm; silver-colored</p>
<p><b>Item No.: 210-112</b> Steel carrier rail; 35 x 7.5 mm; 1 mm thick; 2 m long; slotted; according to EN 60715; "Hole width 25 mm; silver-colored</p>	<p><b>Item No.: 210-504</b> Steel carrier rail; 35 x 7.5 mm; 1 mm thick; 2 m long; slotted; galvanized; according to EN 60715; silver-colored</p>	<p><b>Item No.: 210-113</b> Steel carrier rail; 35 x 7.5 mm; 1 mm thick; 2 m long; unslotted; according to EN 60715; silver-colored</p>	<p><b>Item No.: 210-505</b> Steel carrier rail; 35 x 7.5 mm; 1 mm thick; 2 m long; unslotted; galvanized; according to EN 60715; silver-colored</p>

**1.1.2 Marking**

**1.1.2.1 Group marker carrier**

<p><b>Item No.: 750-106</b> Group marker carrier</p>
--

1.1.2.2 Marker

 <p><b>Item No.: 750-100</b> Marker card; as a DIN A4 sheet; plain</p>	<p><b>Item No.: 2009-145/000-006</b> Mini-WSB Inline; for Smart Printer; 1700 pieces on roll; stretchable 5 - 5.2 mm; plain; snap-on type; blue</p>	<p><b>Item No.: 2009-145/000-007</b> Mini-WSB Inline; for Smart Printer; 1700 pieces on roll; stretchable 5 - 5.2 mm; plain; snap-on type; gray</p>	<p><b>Item No.: 2009-145/000-023</b> Mini-WSB Inline; for Smart Printer; 1700 pieces on roll; stretchable 5 - 5.2 mm; plain; snap-on type; green</p>
<p><b>Item No.: 2009-145/000-012</b> Mini-WSB Inline; for Smart Printer; 1700 pieces on roll; stretchable 5 - 5.2 mm; plain; snap-on type; orange</p>	<p><b>Item No.: 2009-145/000-005</b> Mini-WSB Inline; for Smart Printer; 1700 pieces on roll; stretchable 5 - 5.2 mm; plain; snap-on type; red</p>	<p><b>Item No.: 2009-145/000-024</b> Mini-WSB Inline; for Smart Printer; 1700 pieces on roll; stretchable 5 - 5.2 mm; plain; snap-on type; violet</p>	<p><b>Item No.: 2009-145</b> Mini-WSB Inline; for Smart Printer; 1700 pieces on roll; stretchable 5 - 5.2 mm; plain; snap-on type; white</p>
<p><b>Item No.: 2009-145/000-002</b> Mini-WSB Inline; for Smart Printer; 1700 pieces on roll; stretchable 5 - 5.2 mm; plain; snap-on type; yellow</p>	 <p><b>Item No.: 248-501/000-006</b> Mini-WSB marking card; as card; not stretchable; plain; snap-on type; blue</p>	 <p><b>Item No.: 248-501/000-007</b> Mini-WSB marking card; as card; not stretchable; plain; snap-on type; gray</p>	 <p><b>Item No.: 248-501/000-023</b> Mini-WSB marking card; as card; not stretchable; plain; snap-on type; green</p>
 <p><b>Item No.: 248-501/000-017</b> Mini-WSB marking card; as card; not stretchable; plain; snap-on type; light green</p>	 <p><b>Item No.: 248-501/000-012</b> Mini-WSB marking card; as card; not stretchable; plain; snap-on type; orange</p>	 <p><b>Item No.: 248-501/000-005</b> Mini-WSB marking card; as card; not stretchable; plain; snap-on type; red</p>	 <p><b>Item No.: 248-501/000-024</b> Mini-WSB marking card; as card; not stretchable; plain; snap-on type; violet</p>
 <p><b>Item No.: 248-501</b> Mini-WSB marking card; as card; not stretchable; plain; snap-on type; white</p>	 <p><b>Item No.: 248-501/000-002</b> Mini-WSB marking card; as card; not stretchable; plain; snap-on type; yellow</p>		

1.1.2.3 Marker carrier

 <p><b>Item No.: 750-103</b> Group marker carrier</p>
--

1.1.3 Shield termination

1.1.3.1 Shield clamping saddles

 <p><b>Item No.: 790-108</b> Shield clamping saddle; 11 mm wide; diameter of compatible conductor; 3 ... 8 mm</p>	 <p><b>Item No.: 790-208</b> Shield clamping saddle; 12.4 mm wide; 3 ... 8 mm</p>	 <p><b>Item No.: 790-116</b> Shield clamping saddle; 19 mm wide; diameter of compatible conductor; 7 ... 16 mm</p>	 <p><b>Item No.: 790-216</b> Shield clamping saddle; 21.8 mm wide; 6 ... 16 mm</p>
 <p><b>Item No.: 790-124</b> Shield clamping saddle; 27 mm wide; diameter of compatible conductor; 6 ... 24 mm</p>	 <p><b>Item No.: 790-220</b> Shield clamping saddle; 30 mm wide; 6 ... 20 mm</p>	 <p><b>Item No.: 790-140</b> Shield clamping saddle; diameter of compatible conductor</p>	

### 1.1.4 Supply module

#### 1.1.4.1 Supply module



**Item No.: 750-612**

Power Supply; 0 ... 230 V AC/DC

**Item No.: 750-602**

Power Supply; 24 VDC

**Item No.: 750-601**

Power Supply; 24 VDC; fuse holder

**Item No.: 750-610**

Power Supply; 24 VDC; fuse holder; Diagnostics

### 1.1.5 System enclosure

#### 1.1.5.1 System enclosure



**Item No.: 850-825**

IP65 enclosure; Aluminium (RAL 7032); WxHxD (160x100x160 mm); 9 x M12, 4 x M20

**Item No.: 850-826**

IP65 enclosure; Aluminium (RAL 7032); WxHxD (240x100x160 mm); 4 x M20, 4 x M16, 14 x M12 cable grip

**Item No.: 850-827**

IP65 enclosure; Aluminium (RAL 7032); WxHxD (320x100x160 mm); 4 x M20, 8 x M16, 17 x M12 cable grip

**Item No.: 850-828**

IP65 enclosure; Aluminium (RAL 7032); WxHxD (480x100x160 mm); 4 x M20, 10 x M16, 35 x M12 cable grip



**Item No.: 850-826/002-000**

IP65 enclosure; Aluminium (RAL 7035); WxHxD (240x100x160 mm); 4 x M20, 4 x M16, 14 x M12 cable grip

**Item No.: 850-827/002-000**

IP65 enclosure; Aluminium (RAL 7035); WxHxD (320x100x160 mm); 4 x M20, 8 x M16, 17 x M12 cable grip

**Item No.: 850-828/002-000**

IP65 enclosure; Aluminium (RAL 7035); WxHxD (480x100x160 mm); 4 x M20, 10 x M16, 35 x M12 cable grip

**Item No.: 850-834**

IP65 enclosure; Polyester (RAL 7032); WxHxD (164x100x164 mm); 9 x M12, 4 x M20



**Item No.: 850-835**

IP65 enclosure; Polyester (RAL 7032); WxHxD (244x100x164 mm); 4 x M20, 4 x M16, 14 x M12 cable grip

**Item No.: 850-836**

IP65 enclosure; Polyester (RAL 7032); WxHxD (324x100x164 mm); 4 x M20, 8 x M16, 17 x M12 cable grip

**Item No.: 850-814/002-000**

IP65 enclosure; Sheet steel (RAL 7035); WxHxD (200x120x200 mm); without flange plate

**Item No.: 850-815/002-000**

IP65 enclosure; Sheet steel (RAL 7035); WxHxD (300x120x200 mm); without flange plate



**Item No.: 850-816/002-000**

IP65 enclosure; Sheet steel (RAL 7035); WxHxD (400x120x200 mm); without flange plate

**Item No.: 850-817/002-000**

IP65 enclosure; Sheet steel (RAL 7035); WxHxD (600x120x200 mm); without flange plate