

**Data Sheet | Item Number: 750-456**  
 2-channel analog input;  $\pm 10$  VDC; Differential input

<https://www.wago.com/750-456>

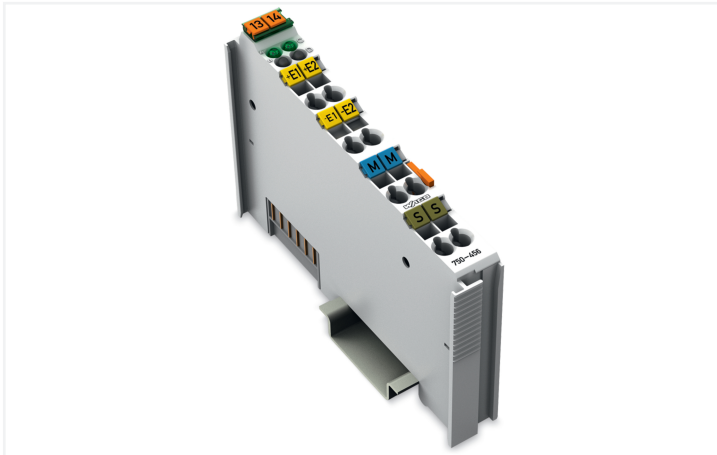

Color: ■ light gray

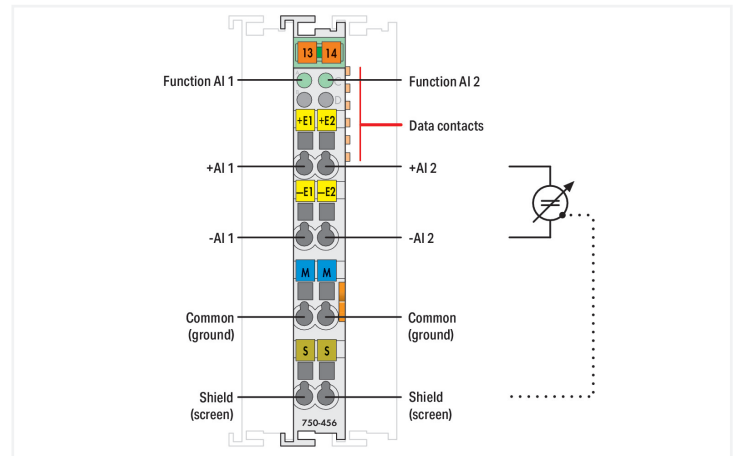
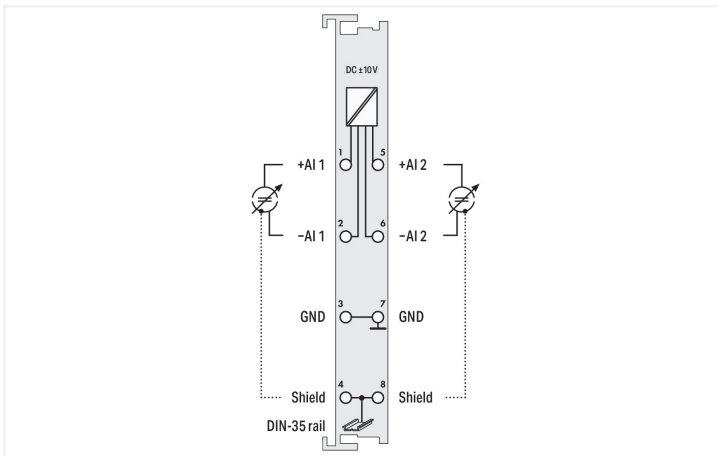
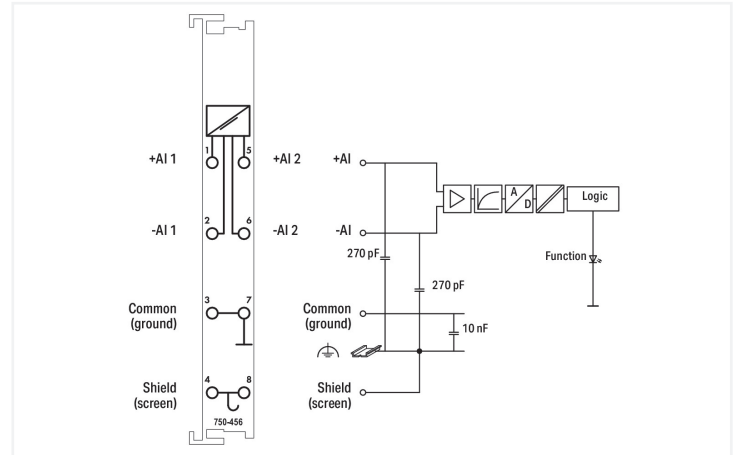

This analog input module processes standard  $\pm 10$  V signals.  
 The input signal is electrically isolated and is transmitted with a resolution of 12 bits.  
 The internal system supply powers the module.  
 The input channels of the module are differential inputs.  
 The shield directly connects to the DIN-rail.

**Technical data**

Number of analog inputs	2
Total number of channels (module)	2
Signal type	Voltage
Signal type (voltage)	-10 ... +10 VDC
Sensor connection	2 x (2-wire)
Input voltage (max.)	35 V
Signal characteristics	Differential
Resolution [bit]	12 bits
Data width	2 x 16-bit data; 2 x 8-bit control/status (optional)
Internal resistance	570 k $\Omega$
Conversion time (typ.)	2 ms
Measurement error (reference temperature)	25 °C
Measurement error, deviation (max.) from the upper-range value	0.2 %
Temperature error (max.) of the upper-range value	0.015 %/K
Supply voltage (system)	5 VDC; via data contacts
Current consumption (5 V system supply)	80 mA
Isolation	500 V system/field
Indicators	LED (A, C) green: Function AI 1, AI 2

### Connection data

Connection technology: inputs/outputs	8 x CAGE CLAMP®
Connection type 1	Inputs/outputs
Solid conductor	0.08 ... 2.5 mm <sup>2</sup> / 28 ... 14 AWG
Fine-stranded conductor	0.08 ... 2.5 mm <sup>2</sup> / 28 ... 14 AWG
Strip length	8 ... 9 mm / 0.31 ... 0.35 inches

### Physical data

Width	12 mm / 0.472 inches
Height	100 mm / 3.937 inches
Depth	69.8 mm / 2.748 inches
Depth from upper-edge of DIN-rail	62.6 mm / 2.465 inches

### Mechanical data

Mounting type	DIN-35 rail
---------------	-------------

### Material data

Color	light gray
Housing material	Polycarbonate; polyamide 6.6
Fire load	1.014 MJ
Weight	49 g
Conformity marking	CE

### Environmental requirements

Ambient temperature (operation)	0 ... +55 °C
Ambient temperature (storage)	-40 ... +85 °C
Protection type	IP20
Pollution degree	2 per IEC 61131-2
Operating altitude	0 ... 2000 m / 0 ... 6562 ft
Mounting position	Horizontal left, horizontal right, horizontal up, horizontal down, vertical top and vertical bottom
Relative humidity (without condensation)	95 %
Vibration resistance	4g per IEC 60068-2-6
Shock resistance	15g per IEC 60068-2-27
EMC immunity to interference	per EN 61000-6-2, marine applications
EMC emission of interference	per EN 61000-6-4, marine applications
Exposure to pollutants	per IEC 60068-2-42 and IEC 60068-2-43
Permissible H <sub>2</sub> S contaminant concentration at a relative humidity 75 %	10 ppm
Permissible SO <sub>2</sub> contaminant concentration at a relative humidity 75 %	25 ppm

### Commercial data

Product Group	15 (I/O System)
eCl@ss 10.0	27-24-26-01
eCl@ss 9.0	27-24-26-01
ETIM 9.0	EC001596
ETIM 8.0	EC001596
PU (SPU)	1 pcs
Packaging type	Box
Country of origin	DE
GTIN	4045454481674
Customs tariff number	8538909990

**Environmental Product Compliance**

CAS-No.	1303-86-2 1317-36-8 7439-92-1
REACH Candidate List Substance	Diboron trioxide Lead Lead monoxide
RoHS Compliance Status	Compliant,With Exemption
RoHS Exemption	6(c) 7(a) 7(c)-I 7(c)-II
SCIP notification number (Austria)	0119b998-0f9c-4e1b-9f4d-9fc63519c6d5
SCIP notification number (Belgium)	122273ac-4c7c-40fc-997f-955e235537c2
SCIP notification number (Bulgaria)	f2d0b1b5-7f9f-433d-9be0-0680bdaf2d39
SCIP notification number (Czech Republic)	5d5f155e-750b-4ef3-bc80-cdcc31c86e50
SCIP notification number (Denmark)	72ffba89-8edb-4e19-b264-a188b0ea60e7
SCIP notification number (Finland)	d979df0c-344d-493e-816a-7b4d16d751b9
SCIP notification number (France)	10e7e5ad-9d65-457d-8fcf-51045ce19a74
SCIP notification number (Germany)	57687a5d-7d75-4c5c-bac8-a631ed21e2ac
SCIP notification number (Hungary)	048c7245-9894-437d-aff0-8a2216cfe9b
SCIP notification number (Italy)	9c9e20ab-9d17-4db1-9c93-8d764929b860
SCIP notification number (Netherlands)	5aa9b272-8bb8-4200-964e-3018995be569
SCIP notification number (Poland)	aaf5c2cc-2ff8-477b-ad4a-b19df2ff17f
SCIP notification number (Romania)	df5bd87e-34ac-4b45-85ae-7cef5323d171
SCIP notification number (Sweden)	31913f81-2286-465b-a33f-9286c12143c5

**Approvals / Certificates**

**General approvals** **Declarations of conformity and manufacturer's declarations**



Approval	Standard	Certificate Name
EAC GZO Almaty Standart	TP TC 020/2011	EAC CoC 03083
KC National Radio Research Agency	Article 58-2, Clause 3	MSIP-REM-W43-AIM750
UL Underwriters Laboratories Inc. (ORDINARY LOCATIONS)	UL 508	E175199

Approval	Standard	Certificate Name
EU-Declaration of Conformity WAGO GmbH & Co. KG	-	-
UK-Declaration of Conformity WAGO GmbH & Co. KG	-	-

**Approvals for marine applications**



Approval	Standard	Certificate Name
ABS American Bureau of Shipping	-	22-2219060
BSH Bundesamt fuer Seeschifffahrt und Hydrographie	-	1104
BV Bureau Veritas S.A.	-	13453/E0 BV

**Approvals for marine applications**

Approval	Standard	Certificate Name
DNV DNV GL SE	DNV-CG-0339, Aug.2021	TAA0000194
KR Korean Register of Shipping	-	KR HMB05880-AC001
LR Lloyds Register EMEA	-	LR22180952TA
PRS Polski Rejestr Statków	-	TE/1101/880590/23
RINA RINA Germany GmbH	-	ELE343521XG001

Approvals for hazardous areas



Approval	Standard	Certificate Name
ATEX TUEV Nord Cert GmbH	EN 60079-0	TUEV14ATEX148929X (II 3 G Ex ec IIC T4 Gc)
CCCEX CQST/CNEX	CNCA-C23-01	2020312310000213 (Ex ec IIC T4 Gc)
IECEX TUEV Nord Cert GmbH	IEC 60079-0	IECEX TUN 14.0035 X (Ex ec IIC T4 Gc)
INMETRO TUV Rheinland do Brasil Ltda.	IEC 60079-0	TUV 12.1297 X
UKEx WAGO GmbH & Co. KG	EN 60079-0	UKCA_WA GO22UKEX003X_ec
UL Underwriters Laboratories Inc. (HAZARDOUS LOCATIONS)	UL 121201	E198726

Downloads

Environmental Product Compliance

Compliance Search
Environmental Product Compliance 750-456 <a href="#">↓</a>

Documentation

Manual			
Product Manual 2-channel, ± 10VDC, diff.	V 1.1.0	pdf 2013.54 KB	<a href="#">↓</a>
System Manual Series 750/753			<a href="#">↓</a>

System Description			
750/753 Series I/O-System – General Product Information		pdf 953.35 KB	<a href="#">↓</a>
Overview on WAGO-I/O-SYSTEM 750 approvals		pdf 770.48 KB	<a href="#">↓</a>

Bid Text			
750-456	19.02.2019	xml 4.18 KB	<a href="#">↓</a>
750-456	17.10.2017	doc 27.00 KB	<a href="#">↓</a>

Instruction Leaflet			
CCC Ex (Additional information)	26.04.2023	pdf 159.76 KB	<a href="#">↓</a>

**CAD/CAE-Data**

CAD data		CAE data	
2D/3D Models 750-456		EPLAN Data Portal 750-456	
		WSCAD Universe 750-456	
		ZUKEN Portal 750-456	

**Device Files**

Device Driver			
WAGO USB Service Kabel Treiber / Serie 750 und 857	6.5.3.0 10.09.2014	zip 4721.96 KB	

**1 Compatible Products**

**1.1 Optional Accessories**

**1.1.1 DIN-rail**

**1.1.1.1 Mounting accessories**



**Item No.: 210-196**  
Aluminum carrier rail; 35 x 8.2 mm; 1.6 mm thick; 2 m long; unslotted; similar to EN 60715; silver-colored



**Item No.: 210-198**  
Copper carrier rail; 35 x 15 mm; 2.3 mm thick; 2 m long; unslotted; according to EN 60715; copper-colored



**Item No.: 210-508**  
Steel carrier rail; 35 x 15 mm; 1.5 mm thick; 2 m long; slotted; galvanized; similar to EN 60715; silver-colored



**Item No.: 210-197**  
Steel carrier rail; 35 x 15 mm; 1.5 mm thick; 2 m long; slotted; similar to EN 60715; silver-colored



**Item No.: 210-506**  
Steel carrier rail; 35 x 15 mm; 1.5 mm thick; 2 m long; unslotted; galvanized; similar to EN 60715; silver-colored



**Item No.: 210-114**  
Steel carrier rail; 35 x 15 mm; 1.5 mm thick; 2 m long; unslotted; similar to EN 60715; silver-colored



**Item No.: 210-118**  
Steel carrier rail; 35 x 15 mm; 2.3 mm thick; 2 m long; unslotted; according to EN 60715; silver-colored



**Item No.: 210-115**  
Steel carrier rail; 35 x 7.5 mm; 1 mm thick; 2 m long; slotted; according to EN 60715; "Hole width 18 mm; silver-colored



**Item No.: 210-112**  
Steel carrier rail; 35 x 7.5 mm; 1 mm thick; 2 m long; slotted; according to EN 60715; "Hole width 25 mm; silver-colored



**Item No.: 210-504**  
Steel carrier rail; 35 x 7.5 mm; 1 mm thick; 2 m long; slotted; galvanized; according to EN 60715; silver-colored



**Item No.: 210-113**  
Steel carrier rail; 35 x 7.5 mm; 1 mm thick; 2 m long; unslotted; according to EN 60715; silver-colored



**Item No.: 210-505**  
Steel carrier rail; 35 x 7.5 mm; 1 mm thick; 2 m long; unslotted; galvanized; according to EN 60715; silver-colored











**1.1.2 Marking**

**1.1.2.1 Group marker carrier**



**Item No.: 750-106**  
Group marker carrier

1.1.2.2 Marker

 <p><b>Item No.: 750-100</b> Marker card; as a DIN A4 sheet; plain</p>	<p><b>Item No.: 2009-145/000-006</b> Mini-WSB Inline; for Smart Printer; 1700 pieces on roll; stretchable 5 - 5.2 mm; plain; snap-on type; blue</p>	<p><b>Item No.: 2009-145/000-007</b> Mini-WSB Inline; for Smart Printer; 1700 pieces on roll; stretchable 5 - 5.2 mm; plain; snap-on type; gray</p>	<p><b>Item No.: 2009-145/000-023</b> Mini-WSB Inline; for Smart Printer; 1700 pieces on roll; stretchable 5 - 5.2 mm; plain; snap-on type; green</p>
<p><b>Item No.: 2009-145/000-012</b> Mini-WSB Inline; for Smart Printer; 1700 pieces on roll; stretchable 5 - 5.2 mm; plain; snap-on type; orange</p>	<p><b>Item No.: 2009-145/000-005</b> Mini-WSB Inline; for Smart Printer; 1700 pieces on roll; stretchable 5 - 5.2 mm; plain; snap-on type; red</p>	<p><b>Item No.: 2009-145/000-024</b> Mini-WSB Inline; for Smart Printer; 1700 pieces on roll; stretchable 5 - 5.2 mm; plain; snap-on type; violet</p>	<p><b>Item No.: 2009-145</b> Mini-WSB Inline; for Smart Printer; 1700 pieces on roll; stretchable 5 - 5.2 mm; plain; snap-on type; white</p>
<p><b>Item No.: 2009-145/000-002</b> Mini-WSB Inline; for Smart Printer; 1700 pieces on roll; stretchable 5 - 5.2 mm; plain; snap-on type; yellow</p>	 <p><b>Item No.: 248-501/000-006</b> Mini-WSB marking card; as card; not stretchable; plain; snap-on type; blue</p>	 <p><b>Item No.: 248-501/000-007</b> Mini-WSB marking card; as card; not stretchable; plain; snap-on type; gray</p>	 <p><b>Item No.: 248-501/000-023</b> Mini-WSB marking card; as card; not stretchable; plain; snap-on type; green</p>
 <p><b>Item No.: 248-501/000-017</b> Mini-WSB marking card; as card; not stretchable; plain; snap-on type; light green</p>	 <p><b>Item No.: 248-501/000-012</b> Mini-WSB marking card; as card; not stretchable; plain; snap-on type; orange</p>	 <p><b>Item No.: 248-501/000-005</b> Mini-WSB marking card; as card; not stretchable; plain; snap-on type; red</p>	 <p><b>Item No.: 248-501/000-024</b> Mini-WSB marking card; as card; not stretchable; plain; snap-on type; violet</p>
 <p><b>Item No.: 248-501</b> Mini-WSB marking card; as card; not stretchable; plain; snap-on type; white</p>	 <p><b>Item No.: 248-501/000-002</b> Mini-WSB marking card; as card; not stretchable; plain; snap-on type; yellow</p>		

1.1.2.3 Marker carrier

 <p><b>Item No.: 750-103</b> Group marker carrier</p>
--

1.1.3 Shield termination

1.1.3.1 Shield clamping saddles

 <p><b>Item No.: 790-108</b> Shield clamping saddle; 11 mm wide; diameter of compatible conductor; 3 ... 8 mm</p>	 <p><b>Item No.: 790-208</b> Shield clamping saddle; 12.4 mm wide; 3 ... 8 mm</p>	 <p><b>Item No.: 790-116</b> Shield clamping saddle; 19 mm wide; diameter of compatible conductor; 7 ... 16 mm</p>	 <p><b>Item No.: 790-216</b> Shield clamping saddle; 21.8 mm wide; 6 ... 16 mm</p>
 <p><b>Item No.: 790-124</b> Shield clamping saddle; 27 mm wide; diameter of compatible conductor; 6 ... 24 mm</p>	 <p><b>Item No.: 790-220</b> Shield clamping saddle; 30 mm wide; 6 ... 20 mm</p>	 <p><b>Item No.: 790-140</b> Shield clamping saddle; diameter of compatible conductor</p>	

## 1.1.4 System enclosure

## 1.1.4.1 System enclosure

**Item No.: 850-825**

IP65 enclosure; Aluminium (RAL 7032);  
WxHxD (160x100x160 mm); 9 x M12, 4 x  
M20

**Item No.: 850-826**

IP65 enclosure; Aluminium (RAL 7032);  
WxHxD (240x100x160 mm); 4 x M20, 4 x  
M16, 14 x M12 cable grip

**Item No.: 850-827**

IP65 enclosure; Aluminium (RAL 7032);  
WxHxD (320x100x160 mm); 4 x M20, 8 x  
M16, 17 x M12 cable grip

**Item No.: 850-828**

IP65 enclosure; Aluminium (RAL 7032);  
WxHxD (480x100x160 mm); 4 x M20, 10 x  
M16, 35 x M12 cable grip

**Item No.: 850-826/002-000**

IP65 enclosure; Aluminium (RAL 7035);  
WxHxD (240x100x160 mm); 4 x M20, 4 x  
M16, 14 x M12 cable grip

**Item No.: 850-827/002-000**

IP65 enclosure; Aluminium (RAL 7035);  
WxHxD (320x100x160 mm); 4 x M20, 8 x  
M16, 17 x M12 cable grip

**Item No.: 850-828/002-000**

IP65 enclosure; Aluminium (RAL 7035);  
WxHxD (480x100x160 mm); 4 x M20, 10 x  
M16, 35 x M12 cable grip

**Item No.: 850-834**

IP65 enclosure; Polyester (RAL 7032); Wx-  
HxD (164x100x164 mm); 9 x M12, 4 x M20

**Item No.: 850-835**

IP65 enclosure; Polyester (RAL 7032); Wx-  
HxD (244x100x164 mm); 4 x M20, 4 x  
M16, 14 x M12 cable grip

**Item No.: 850-836**

IP65 enclosure; Polyester (RAL 7032);  
WxHxD (324x100x164 mm); 4 x M20, 8 x  
M16, 17 x M12 cable grip

**Item No.: 850-814/002-000**

IP65 enclosure; Sheet steel (RAL 7035);  
WxHxD (200x120x200 mm); without flan-  
ge plate

**Item No.: 850-815/002-000**

IP65 enclosure; Sheet steel (RAL 7035);  
WxHxD (300x120x200 mm); without flan-  
ge plate

**Item No.: 850-816/002-000**

IP65 enclosure; Sheet steel (RAL 7035);  
WxHxD (400x120x200 mm); without flan-  
ge plate

**Item No.: 850-817/002-000**

IP65 enclosure; Sheet steel (RAL 7035);  
WxHxD (600x120x200 mm); without flan-  
ge plate