

Data Sheet | Item Number: 745-1353

PCB terminal block; 6 mm²; Pin spacing 10 mm; 3-pole; CAGE CLAMP®; commoning option; 6,00 mm²; gray

<https://www.wago.com/745-1353>

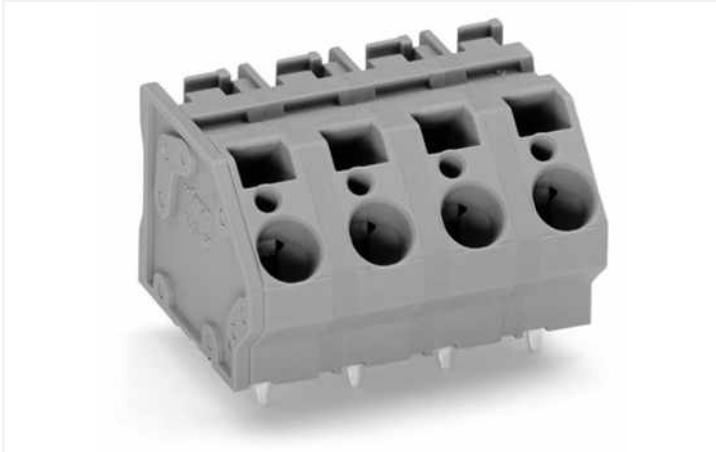

Color: ■ gray

Similar to illustration

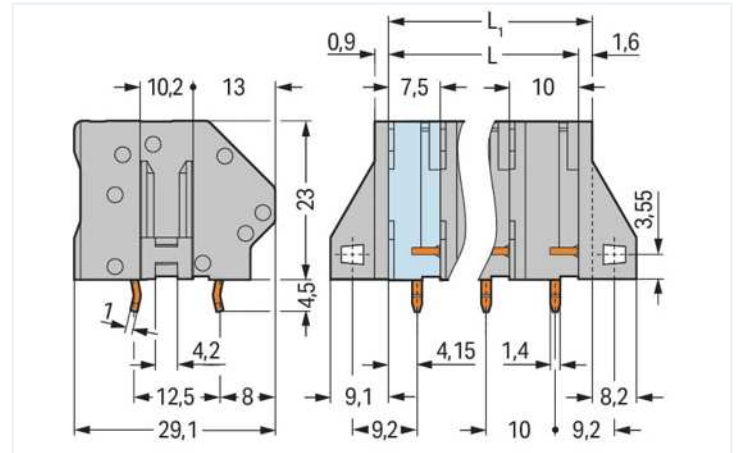

Dimensions in mm

$L = (\text{pole no.} - 1) \times \text{pin spacing} + 7.5 \text{ mm}$

$L1 = L + 1.6 \text{ mm} \triangleq \text{version without mounting flange}$

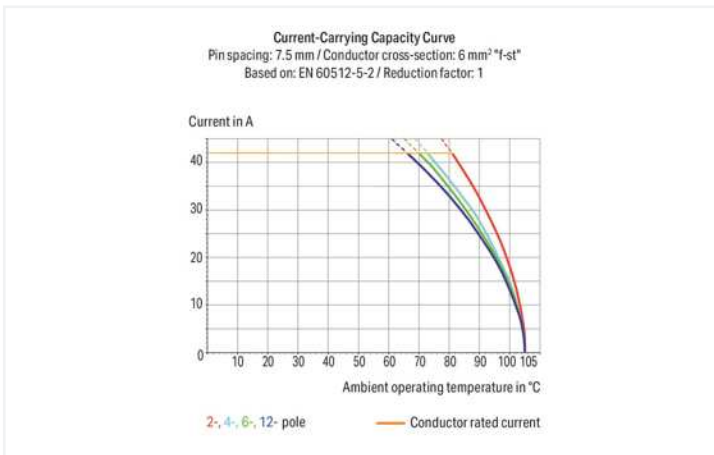

- Terminal strips with screwdriver-actuated CAGE CLAMP® connection
- Versions with Ex approval
- Unrestricted UL approval up to 600 V with 12.5 mm pin spacing
- Double solder pins for high mechanical stability
- Custom color combinations
- Integrated testing tap
- Marker slot for Mini-WSB and WMB markers

Notes

Variants:

Other pole numbers
Versions for Ex e II and Ex i
Other colors
Mixed-color PCB connector strips
Versions with mounting flanges
Direct marking
Other versions (or variants) can be requested from WAGO Sales or configured at <https://configurator.wago.com/>.

Subject to changes. Please also observe the further product documentation!

Current addresses can be found at: www.wago.com

Electrical data

Ratings per IEC/EN

| | |
|-------------------------------|---|
| Ratings per | IEC/EN 60664-1 |
| Nominal voltage (III/3) | 800 V |
| Rated impulse voltage (III/3) | 8 kV |
| Rated voltage (III/2) | 1000 V |
| Rated impulse voltage (III/2) | 8 kV |
| Nominal voltage (II/2) | 1000 V |
| Rated surge voltage (II/2) | 8 kV |
| Rated current | 41 A |
| Legend (ratings) | (III / 2) \triangle Overvoltage category III / Pollution degree 2 |

Ratings per UL 1059

| | |
|--------------------------------|---------|
| Approvals per | UL 1059 |
| Rated voltage UL (Use Group B) | 300 V |
| Rated current UL (Use Group B) | 10 A |
| Rated voltage UL (Use Group C) | 300 V |
| Rated current UL (Use Group C) | 10 A |
| Rated voltage UL (Use Group D) | 600 V |
| Rated current UL (Use Group D) | 5 A |

Ratings per CSA

| | |
|---------------------------------|-------|
| Approvals per | CSA |
| Rated voltage CSA (Use Group B) | 300 V |
| Rated current CSA (Use Group B) | 10 A |
| Rated voltage CSA (Use Group C) | 300 V |
| Rated current CSA (Use Group C) | 10 A |
| Rated voltage CSA (Use Group D) | 600 V |
| Rated current CSA (Use Group D) | 5 A |

Connection data

| | |
|----------------------------|---|
| Connection points | 3 |
| Total number of potentials | 3 |
| Number of connection types | 1 |
| Number of levels | 1 |

Connection 1

| | |
|---|---|
| Connection technology | CAGE CLAMP® |
| Actuation type | Operating tool |
| Solid conductor | 0.2 ... 6 mm ² / 24 ... 10 AWG |
| Fine-stranded conductor | 0.2 ... 6 mm ² / 24 ... 10 AWG |
| Fine-stranded conductor; with insulated ferrule | 0.25 ... 4 mm ² |
| Fine-stranded conductor; with uninsulated ferrule | 0.25 ... 4 mm ² |
| Strip length | 11 ... 12 mm / 0.43 ... 0.47 inches |
| Conductor connection direction to PCB | 45 ° |
| Pole number | 3 |

Physical data

| | |
|--------------------------------------|--------------------------|
| Pin spacing | 10 mm / 0.394 inches |
| Width | 29.1 mm / 1.146 inches |
| Height | 27.5 mm / 1.083 inches |
| Height from the surface | 23 mm / 0.906 inches |
| Depth | 29.1 mm / 1.146 inches |
| Solder pin length | 4.5 mm |
| Solder pin dimensions | 1 x 1.4 mm |
| Drilled hole diameter with tolerance | 1.8 ^(+0.1) mm |

PCB contact

| | |
|-------------------------------------|--|
| PCB contact | THT |
| Solder pin arrangement | over the entire terminal strip (in-line) |
| Number of solder pins per potential | 2 |

Material Data

| | |
|-----------------------------|--|
| Note (material data) | Information on material specifications can be found here |
| Color | gray |
| Material group | I |
| Insulation material | Polyamide (PA66) |
| Flammability class per UL94 | V0 |
| Clamping spring material | Chrome-nickel spring steel (CrNi) |
| Contact material | Electrolytic copper (E _{Cu}) |
| Contact plating | Tin |
| Fire load | 0.294 MJ |
| Weight | 16.8 g |

Environmental requirements

| | |
|-------------------------|-----------------|
| Limit temperature range | -60 ... +105 °C |
|-------------------------|-----------------|

Commercial data

| | |
|-----------------------|--------------------------------|
| Product Group | 4 (Printed Circuit Connectors) |
| eCl@ss 10.0 | 27-44-04-01 |
| eCl@ss 9.0 | 27-44-04-01 |
| ETIM 8.0 | EC002643 |
| ETIM 7.0 | EC002643 |
| PU (SPU) | 72 pcs |
| Packaging type | Box |
| Country of origin | PL |
| GTIN | 4045454472221 |
| Customs tariff number | 85369010000 |

Approvals / Certificates

General approvals



| Approval | Standard | Certificate Name |
|--|---------------|------------------|
| CCA DEKRA Certification B.V. | EN 60947 | NTR NL-7097 |
| CCA DEKRA Certification B.V. | EN 60947 | 2160584.16 |
| CSA DEKRA Certification B.V. | C22.2 No. 158 | 1604421 |
| cURus Underwriters Laboratories Inc. | UL 1059 | E45172 |

Downloads

Environmental Product Compliance

| | | | |
|---|--|--|---|
| Compliance Search | | | |
| Environmental Product Compliance 745-1353 | | | ↓ |

Documentation

| | | | |
|------------------------|------------|-------------------|---|
| Additional Information | | | |
| Technical Section | 03.04.2019 | pdf 1949.09 KB | ↓ |

CAD/CAE-Data

| | |
|--------------------------|---|
| CAD data | |
| 2D/3D Models 745-1353 | ↓ |

| | |
|-------------------------------|---|
| CAE data | |
| EPLAN Data Portal 745-1353 | ↓ |

| | |
|--------------------------|---|
| ZUKEN Portal 745-1353 | ↓ |
|--------------------------|---|

1 Compatible Products



















1.1 Optional Accessories

1.1.1 Ferrule

1.1.1.1 Ferrule

| | | | |
|---|--|---|---|
| | | | |
| <p>Item No.: 216-301 Ferrule; Sleeve for 0.25 mm² / AWG 24; insulated; electro-tin plated; yellow</p> | <p>Item No.: 216-321 Ferrule; Sleeve for 0.25 mm² / AWG 24; insulated; electro-tin plated; yellow</p> | <p>Item No.: 216-151 Ferrule; Sleeve for 0.25 mm² / AWG 24; uninsulated; electro-tin plated</p> | <p>Item No.: 216-131 Ferrule; Sleeve for 0.25 mm² / AWG 24; uninsulated; electro-tin plated; silver-colored</p> |
| | | | |
| <p>Item No.: 216-302 Ferrule; Sleeve for 0.34 mm² / 22 AWG; insulated; electro-tin plated; light turquoise</p> | <p>Item No.: 216-322 Ferrule; Sleeve for 0.34 mm² / 22 AWG; insulated; electro-tin plated; light turquoise</p> | <p>Item No.: 216-132 Ferrule; Sleeve for 0.34 mm² / AWG 24; uninsulated; electro-tin plated</p> | <p>Item No.: 216-152 Ferrule; Sleeve for 0.34 mm² / AWG 24; uninsulated; electro-tin plated</p> |
| | | | |
| <p>Item No.: 216-241 Ferrule; Sleeve for 0.5 mm² / 20 AWG; insulated; electro-tin plated; electrolytic copper; gastight crimped; acc. to DIN 46228, Part 4/09.90; white</p> | <p>Item No.: 216-201 Ferrule; Sleeve for 0.5 mm² / 20 AWG; insulated; electro-tin plated; white</p> | <p>Item No.: 216-221 Ferrule; Sleeve for 0.5 mm² / 20 AWG; insulated; electro-tin plated; white</p> | <p>Item No.: 216-141 Ferrule; Sleeve for 0.5 mm² / 20 AWG; uninsulated; electro-tin plated; electrolytic copper; gastight crimped; acc. to DIN 46228, Part 1/08.92</p> |
| | | | |
| <p>Item No.: 216-101 Ferrule; Sleeve for 0.5 mm² / AWG 22; uninsulated; electro-tin plated; silver-colored</p> | <p>Item No.: 216-121 Ferrule; Sleeve for 0.5 mm² / AWG 22; uninsulated; electro-tin plated; silver-colored</p> | <p>Item No.: 216-242 Ferrule; Sleeve for 0.75 mm² / 18 AWG; insulated; electro-tin plated; electrolytic copper; gastight crimped; acc. to DIN 46228, Part 4/09.90; gray</p> | <p>Item No.: 216-262 Ferrule; Sleeve for 0.75 mm² / 18 AWG; insulated; electro-tin plated; electrolytic copper; gastight crimped; acc. to DIN 46228, Part 4/09.90; gray</p> |

1.1.1.1 Ferrule

| | | | |
|---|---|--|--|
|  <p>Item No.: 216-202 Ferrule; Sleeve for 0.75 mm² / 18 AWG; insulated; electro-tin plated; gray</p> |  <p>Item No.: 216-222 Ferrule; Sleeve for 0.75 mm² / 18 AWG; insulated; electro-tin plated; gray</p> |  <p>Item No.: 216-142 Ferrule; Sleeve for 0.75 mm² / 18 AWG; uninsulated; electro-tin plated; electrolytic copper; gastight crimped; acc. to DIN 46228, Part 1/08.92</p> |  <p>Item No.: 216-102 Ferrule; Sleeve for 0.75 mm² / AWG 20; uninsulated; electro-tin plated; silver-colored</p> |
|  <p>Item No.: 216-122 Ferrule; Sleeve for 0.75 mm² / AWG 20; uninsulated; electro-tin plated; silver-colored</p> |  <p>Item No.: 216-243 Ferrule; Sleeve for 1 mm² / AWG 18; insulated; electro-tin plated; electrolytic copper; gastight crimped; acc. to DIN 46228, Part 4/09.90; red</p> |  <p>Item No.: 216-263 Ferrule; Sleeve for 1 mm² / AWG 18; insulated; electro-tin plated; electrolytic copper; gastight crimped; acc. to DIN 46228, Part 4/09.90; red</p> |  <p>Item No.: 216-203 Ferrule; Sleeve for 1 mm² / AWG 18; insulated; electro-tin plated; red</p> |
|  <p>Item No.: 216-223 Ferrule; Sleeve for 1 mm² / AWG 18; insulated; electro-tin plated; red</p> |  <p>Item No.: 216-103 Ferrule; Sleeve for 1 mm² / AWG 18; uninsulated; electro-tin plated</p> |  <p>Item No.: 216-143 Ferrule; Sleeve for 1 mm² / AWG 18; uninsulated; electro-tin plated; electrolytic copper; gastight crimped; acc. to DIN 46228, Part 1/08.92</p> |  <p>Item No.: 216-123 Ferrule; Sleeve for 1 mm² / AWG 18; uninsulated; electro-tin plated; silver-colored</p> |
|  <p>Item No.: 216-204 Ferrule; Sleeve for 1.5 mm² / AWG 16; insulated; electro-tin plated; black</p> |  <p>Item No.: 216-224 Ferrule; Sleeve for 1.5 mm² / AWG 16; insulated; electro-tin plated; black</p> |  <p>Item No.: 216-244 Ferrule; Sleeve for 1.5 mm² / AWG 16; insulated; electro-tin plated; electrolytic copper; gastight crimped; acc. to DIN 46228, Part 4/09.90; black</p> |  <p>Item No.: 216-264 Ferrule; Sleeve for 1.5 mm² / AWG 16; insulated; electro-tin plated; electrolytic copper; gastight crimped; acc. to DIN 46228, Part 4/09.90; black</p> |
|  <p>Item No.: 216-284 Ferrule; Sleeve for 1.5 mm² / AWG 16; insulated; electro-tin plated; electrolytic copper; gastight crimped; acc. to DIN 46228, Part 4/09.90; black</p> |  <p>Item No.: 216-124 Ferrule; Sleeve for 1.5 mm² / AWG 16; uninsulated; electro-tin plated</p> |  <p>Item No.: 216-144 Ferrule; Sleeve for 1.5 mm² / AWG 16; uninsulated; electro-tin plated; electrolytic copper; gastight crimped; acc. to DIN 46228, Part 1/08.92; silver-colored</p> |  <p>Item No.: 216-104 Ferrule; Sleeve for 1.5 mm² / AWG 16; uninsulated; electro-tin plated; silver-colored</p> |
|  <p>Item No.: 216-205 Ferrule; Sleeve for 2.08 mm² / AWG 14; insulated; electro-tin plated; yellow</p> |  <p>Item No.: 216-206 Ferrule; Sleeve for 2.5 mm² / AWG 14; insulated; electro-tin plated; blue</p> |  <p>Item No.: 216-246 Ferrule; Sleeve for 2.5 mm² / AWG 14; insulated; electro-tin plated; electrolytic copper; gastight crimped; acc. to DIN 46228, Part 4/09.90; blue</p> |  <p>Item No.: 216-266 Ferrule; Sleeve for 2.5 mm² / AWG 14; insulated; electro-tin plated; electrolytic copper; gastight crimped; acc. to DIN 46228, Part 4/09.90; blue</p> |

Subject to changes. Please also observe the further product documentation!

Current addresses can be found at: www.wago.com