

# Data Sheet | Item Number: 736-116

Double-deck PCB terminal block; 2.5 mm<sup>2</sup>; Pin spacing 5 mm; 32-pole; CAGE

CLAMP®; 2,50 mm<sup>2</sup>; gray

<https://www.wago.com/736-116>

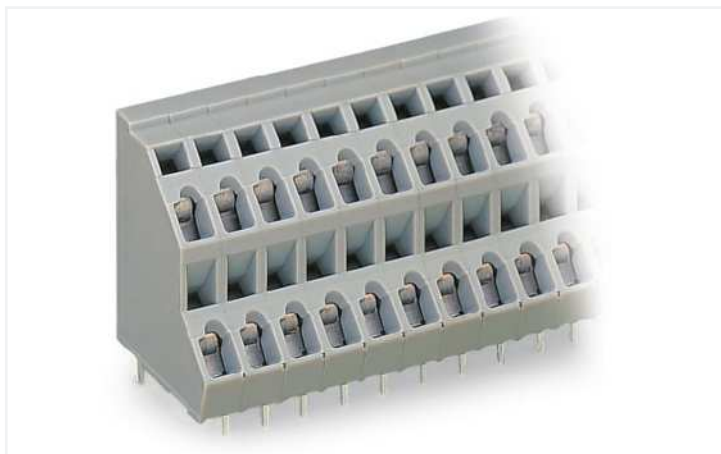

Color: ■ gray

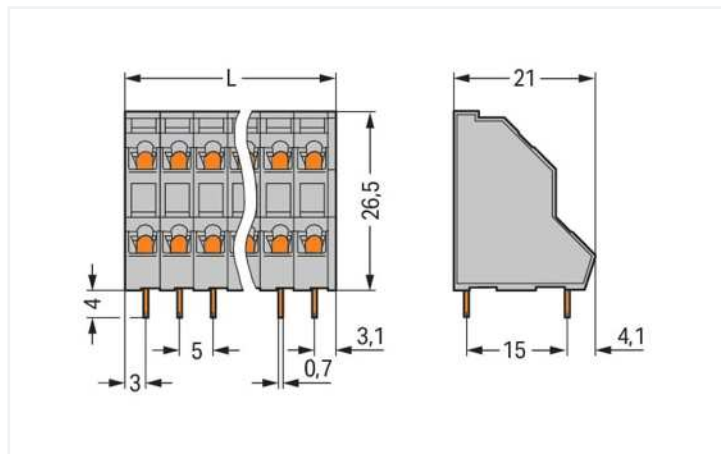

Dimensions in mm

$$L = ((\text{pole no.} / 2) \times \text{pin spacing}) + 1 \text{ mm}$$

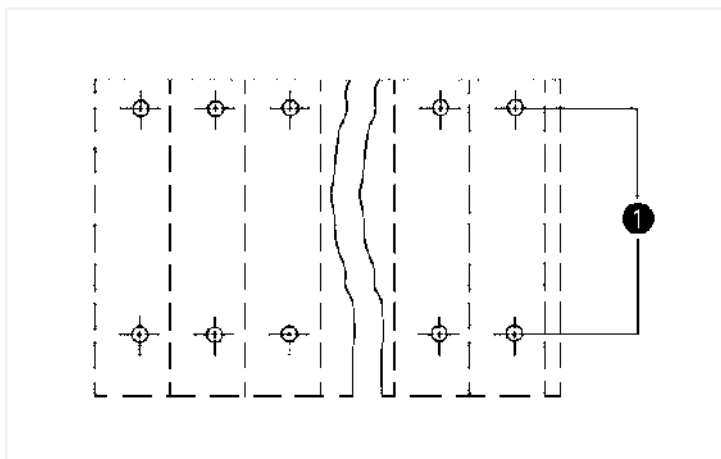

(1) Solder pins in line

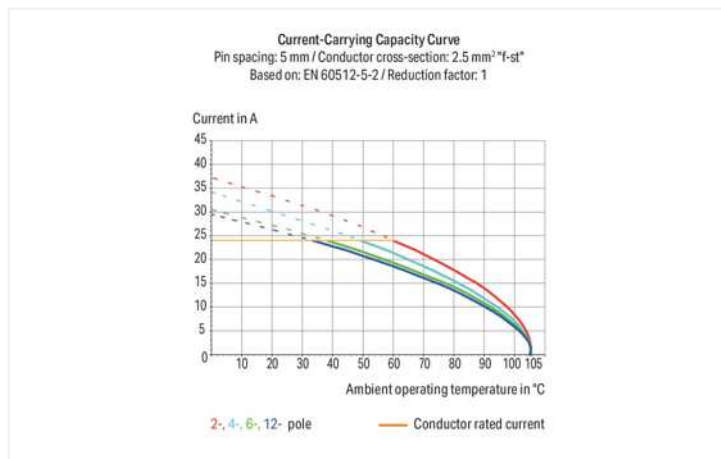

- PCB terminal strips with screwdriver-actuated CAGE CLAMP® connection
- High-density, double-deck design for space-efficient wiring of multiple conductors in confined areas
- Custom marking for all termination levels

## Notes

Variants:

Other pole numbers  
Other colors  
Mixed-color PCB connector strips  
Direct marking  
Other versions (or variants) can be requested from WAGO Sales or configured at <https://configurator.wago.com/>.

## Electrical data

### Ratings per IEC/EN

Ratings per	IEC/EN 60664-1
Bemessungsdaten_Instanzen_Bezeichnung_01	between the modules
Nominal voltage (III/3)	250 V
Rated impulse voltage (III/3)	4 kV
Rated voltage (III/2)	320 V
Rated impulse voltage (III/2)	4 kV
Nominal voltage (II/2)	630 V

### Ratings per IEC/EN

Rated surge voltage (II/2)	4 kV
Rated current	21 A
Legend (ratings)	(III / 2) ≙ Overvoltage category III / Pollution degree 2

### Ratings per IEC/EN 2

Ratings per 2	IEC/EN 60664-1
Bemessungsdaten_Instanzen_Bezeichnung_02	between the decks
Rated voltage (III/3) 2	320 V
Rated surge voltage (III/3) 2	4 kV
Rated voltage (III/2) 2	320 V
Rated surge voltage (III/2) 2	4 kV
Rated voltage (II/2) 2	630 V
Rated surge voltage (II/2) 2	4 kV
Rated current 2	21 A

### Ratings per UL 1059

Approvals per	UL 1059
Rated voltage UL (Use Group B)	300 V
Rated current UL (Use Group B)	10 A
Rated voltage UL (Use Group D)	300 V
Rated current UL (Use Group D)	10 A

### Ratings per CSA

Approvals per	CSA
Rated voltage CSA (Use Group B)	300 V
Rated current CSA (Use Group B)	10 A
Rated voltage CSA (Use Group D)	300 V
Rated current CSA (Use Group D)	10 A

### Connection data

Connection points	32
Total number of potentials	32
Number of connection types	1
Number of levels	2

### Connection 1

Connection technology	CAGE CLAMP®
Actuation type	Operating tool
Solid conductor	0.08 ... 2.5 mm <sup>2</sup> / 28 ... 12 AWG
Fine-stranded conductor	0.08 ... 2.5 mm <sup>2</sup> / 28 ... 12 AWG
Fine-stranded conductor; with insulated ferrule	0.25 ... 1.5 mm <sup>2</sup>
Fine-stranded conductor; with uninsulated ferrule	0.25 ... 2.5 mm <sup>2</sup>
Note (conductor cross-section)	12 AWG: THHN, THWN
Strip length	5 ... 6 mm / 0.2 ... 0.24 inches
Conductor connection direction to PCB	45°
Pole number	32

### Physical data

Pin spacing	5 mm / 0.197 inches
Width	81 mm / 3.189 inches
Height	30.5 mm / 1.201 inches
Height from the surface	26.5 mm / 1.043 inches
Depth	21 mm / 0.827 inches
Solder pin length	4 mm
Solder pin dimensions	0.7 x 0.7 mm
Drilled hole diameter with tolerance	1.3 (+0.1) mm

### PCB contact

PCB contact	THT
Solder pin arrangement	within the terminal block (in-line)
Number of solder pins per potential	1

### Material Data

Note (material data)	<a href="#">Information on material specifications can be found here</a>
Color	gray
Material group	I
Insulation material	Polyamide (PA66)
Flammability class per UL94	V0
Clamping spring material	Chrome-nickel spring steel (CrNi)
Contact material	Electrolytic copper (E <sub>Cu</sub> )
Contact plating	Tin
Fire load	0.555 MJ
Weight	36.7 g

### Environmental requirements

Limit temperature range	-60 ... +105 °C
-------------------------	-----------------

### Commercial data

Product Group	4 (Printed Circuit Connectors)
eCl@ss 10.0	27-44-04-01
eCl@ss 9.0	27-44-04-01
ETIM 8.0	EC002643
ETIM 7.0	EC002643
PU (SPU)	21 pcs
Packaging type	Box
Country of origin	PL
GTIN	4044918913744
Customs tariff number	85369010000

### Approvals / Certificates

#### General approvals



Approval	Standard	Certificate Name
CCA DEKRA Certification B.V.	EN 60947	2160584.37
CCA DEKRA Certification B.V.	EN 60947	NTR NL-7143
CCA DEKRA Certification B.V.	IEC 60947-7-4	NTR NL-7307
CSA DEKRA Certification B.V.	C22.2 No. 158	70049157
UR Underwriters Laboratories Inc.	UL 1059	E45172

#### Approvals for marine applications



Approval	Standard	Certificate Name
ABS American Bureau of Ship- ping	-	19-HG1869876-PDA
BV Bureau Veritas S.A.	IEC 60998	11915/D0 BV
DNV GL Det Norske Veritas, Ger- manischer Lloyd	-	TAE000016Z

Downloads

Environmental Product Compliance

Compliance Search	
Environmental Product Compliance 736-116	<a href="#">↓</a>

Documentation

Additional Information			
Technical Section	03.04.2019	pdf 1949.09 KB	<a href="#">↓</a>
Gebrückte Klemmenleisten für Leiterplatten		pdf 303.71 KB	<a href="#">↓</a>

CAD/CAE-Data

CAD data	
2D/3D Models 736-116	<a href="#">↓</a>

CAE data	
EPLAN Data Portal 736-116	<a href="#">↓</a>
ZUKEN Portal 736-116	<a href="#">↓</a>

1 Compatible Products





















1.1 Optional Accessories

1.1.1 Ferrule

1.1.1.1 Ferrule





<a href="#">Item No.: 216-301</a> Ferrule; Sleeve for 0.25 mm <sup>2</sup> / AWG 24; insulated; electro-tin plated; yellow	<a href="#">Item No.: 216-321</a> Ferrule; Sleeve for 0.25 mm <sup>2</sup> / AWG 24; insulated; electro-tin plated; yellow	<a href="#">Item No.: 216-151</a> Ferrule; Sleeve for 0.25 mm <sup>2</sup> / AWG 24; uninsulated; electro-tin plated	<a href="#">Item No.: 216-131</a> Ferrule; Sleeve for 0.25 mm <sup>2</sup> / AWG 24; uninsulated; electro-tin plated; silver-colored
<a href="#">Item No.: 216-302</a> Ferrule; Sleeve for 0.34 mm <sup>2</sup> / 22 AWG; insulated; electro-tin plated; light turquoise	<a href="#">Item No.: 216-322</a> Ferrule; Sleeve for 0.34 mm <sup>2</sup> / 22 AWG; insulated; electro-tin plated; light turquoise	<a href="#">Item No.: 216-132</a> Ferrule; Sleeve for 0.34 mm <sup>2</sup> / AWG 24; uninsulated; electro-tin plated	<a href="#">Item No.: 216-152</a> Ferrule; Sleeve for 0.34 mm <sup>2</sup> / AWG 24; uninsulated; electro-tin plated
<a href="#">Item No.: 216-241</a> Ferrule; Sleeve for 0.5 mm <sup>2</sup> / 20 AWG; insulated; electro-tin plated; electrolytic copper; gastight crimped; acc. to DIN 46228, Part 4/09.90; white	<a href="#">Item No.: 216-201</a> Ferrule; Sleeve for 0.5 mm <sup>2</sup> / 20 AWG; insulated; electro-tin plated; white	<a href="#">Item No.: 216-221</a> Ferrule; Sleeve for 0.5 mm <sup>2</sup> / 20 AWG; insulated; electro-tin plated; white	<a href="#">Item No.: 216-141</a> Ferrule; Sleeve for 0.5 mm <sup>2</sup> / 20 AWG; insulated; electro-tin plated; electrolytic copper; gastight crimped; acc. to DIN 46228, Part 1/08.92
<a href="#">Item No.: 216-101</a> Ferrule; Sleeve for 0.5 mm <sup>2</sup> / AWG 22; uninsulated; electro-tin plated; silver-colored	<a href="#">Item No.: 216-121</a> Ferrule; Sleeve for 0.5 mm <sup>2</sup> / AWG 22; uninsulated; electro-tin plated; silver-colored	<a href="#">Item No.: 216-242</a> Ferrule; Sleeve for 0.75 mm <sup>2</sup> / 18 AWG; insulated; electro-tin plated; electrolytic copper; gastight crimped; acc. to DIN 46228, Part 4/09.90; gray	<a href="#">Item No.: 216-262</a> Ferrule; Sleeve for 0.75 mm <sup>2</sup> / 18 AWG; insulated; electro-tin plated; electrolytic copper; gastight crimped; acc. to DIN 46228, Part 4/09.90; gray

### 1.1.1.1 Ferrule

 <b>Item No.: 216-202</b> Ferrule; Sleeve for 0.75 mm <sup>2</sup> / 18 AWG; insulated; electro-tin plated; gray	 <b>Item No.: 216-222</b> Ferrule; Sleeve for 0.75 mm <sup>2</sup> / 18 AWG; insulated; electro-tin plated; gray	 <b>Item No.: 216-142</b> Ferrule; Sleeve for 0.75 mm <sup>2</sup> / 18 AWG; uninsulated; electro-tin plated; electrolytic copper; gastight crimped; acc. to DIN 46228, Part 1/08.92	 <b>Item No.: 216-102</b> Ferrule; Sleeve for 0.75 mm <sup>2</sup> / AWG 20; uninsulated; electro-tin plated; silver-colored
 <b>Item No.: 216-122</b> Ferrule; Sleeve for 0.75 mm <sup>2</sup> / AWG 20; uninsulated; electro-tin plated; silver-colored	 <b>Item No.: 216-243</b> Ferrule; Sleeve for 1 mm <sup>2</sup> / AWG 18; insulated; electro-tin plated; electrolytic copper; gastight crimped; acc. to DIN 46228, Part 4/09.90; red	 <b>Item No.: 216-263</b> Ferrule; Sleeve for 1 mm <sup>2</sup> / AWG 18; insulated; electro-tin plated; electrolytic copper; gastight crimped; acc. to DIN 46228, Part 4/09.90; red	 <b>Item No.: 216-203</b> Ferrule; Sleeve for 1 mm <sup>2</sup> / AWG 18; insulated; electro-tin plated; red
 <b>Item No.: 216-223</b> Ferrule; Sleeve for 1 mm <sup>2</sup> / AWG 18; insulated; electro-tin plated; red	 <b>Item No.: 216-103</b> Ferrule; Sleeve for 1 mm <sup>2</sup> / AWG 18; uninsulated; electro-tin plated	 <b>Item No.: 216-143</b> Ferrule; Sleeve for 1 mm <sup>2</sup> / AWG 18; uninsulated; electro-tin plated; electrolytic copper; gastight crimped; acc. to DIN 46228, Part 1/08.92	 <b>Item No.: 216-123</b> Ferrule; Sleeve for 1 mm <sup>2</sup> / AWG 18; uninsulated; electro-tin plated; silver-colored
 <b>Item No.: 216-204</b> Ferrule; Sleeve for 1.5 mm <sup>2</sup> / AWG 16; insulated; electro-tin plated; black	 <b>Item No.: 216-224</b> Ferrule; Sleeve for 1.5 mm <sup>2</sup> / AWG 16; insulated; electro-tin plated; black	 <b>Item No.: 216-244</b> Ferrule; Sleeve for 1.5 mm <sup>2</sup> / AWG 16; insulated; electro-tin plated; electrolytic copper; gastight crimped; acc. to DIN 46228, Part 4/09.90; black	 <b>Item No.: 216-264</b> Ferrule; Sleeve for 1.5 mm <sup>2</sup> / AWG 16; insulated; electro-tin plated; electrolytic copper; gastight crimped; acc. to DIN 46228, Part 4/09.90; black
 <b>Item No.: 216-284</b> Ferrule; Sleeve for 1.5 mm <sup>2</sup> / AWG 16; insulated; electro-tin plated; electrolytic copper; gastight crimped; acc. to DIN 46228, Part 4/09.90; black	 <b>Item No.: 216-124</b> Ferrule; Sleeve for 1.5 mm <sup>2</sup> / AWG 16; uninsulated; electro-tin plated	 <b>Item No.: 216-144</b> Ferrule; Sleeve for 1.5 mm <sup>2</sup> / AWG 16; uninsulated; electro-tin plated; electrolytic copper; gastight crimped; acc. to DIN 46228, Part 1/08.92; silver-colored	 <b>Item No.: 216-104</b> Ferrule; Sleeve for 1.5 mm <sup>2</sup> / AWG 16; uninsulated; electro-tin plated; silver-colored
 <b>Item No.: 216-106</b> Ferrule; Sleeve for 2.5 mm <sup>2</sup> / AWG 14; uninsulated; electro-tin plated; silver-colored			

### 1.1.2 Marking

#### 1.1.2.1 Marking strip

 <b>Item No.: 210-332/500-202</b> Marking strips; as a DIN A4 sheet; MARKED; 1-16 (160x); Height of marker strip: 3 mm; Strip length 182 mm; Horizontal marking; Self-adhesive; white	 <b>Item No.: 210-332/500-205</b> Marking strips; as a DIN A4 sheet; MARKED; 1-32 (80x); Height of marker strip: 3 mm; Strip length 182 mm; Horizontal marking; Self-adhesive; white	 <b>Item No.: 210-332/500-204</b> Marking strips; as a DIN A4 sheet; MARKED; 17-32 (160x); Height of marker strip: 3 mm; Strip length 182 mm; Horizontal marking; Self-adhesive; white	 <b>Item No.: 210-332/500-206</b> Marking strips; as a DIN A4 sheet; MARKED; 33-48 (160x); Height of marker strip: 3 mm; Strip length 182 mm; Horizontal marking; Self-adhesive; white
--	---	--	---

### 1.1.3 Test and measurement

1.1.3.1 Testing accessories



**Item No.: 231-126**

Testing plug module with contact stud; for 280, 736, 737, 738, 780 Series; Pin spacing 5 mm / 0.197 in; 2,50 mm<sup>2</sup>; gray

**Item No.: 231-155**

Testing plug module with contact stud; Pin spacing 5 mm / 0.197 in; 2,50 mm<sup>2</sup>; gray

1.1.4 Tool

1.1.4.1 Operating tool



**Item No.: 210-658**

Operating tool; Blade: 3.5 x 0.5 mm; with a partially insulated shaft; angled; short; multicoloured

**Item No.: 210-720**

Operating tool; Blade: 3.5 x 0.5 mm; with a partially insulated shaft; multicoloured

**Item No.: 210-657**

Operating tool; Blade: 3.5 x 0.5 mm; with a partially insulated shaft; short; multicoloured

Installation Notes

Conductor termination



Inserting a conductor via 3.5 mm screwdriver.

Screwdriver actuation parallel to conductor entry

Installation



Low space requirements due to high-density design  
Double-deck PCB terminal strip – 736 Series



Possible combination:  
Double- (736 Series) and triple-deck PCB terminal strips (737 Series) upon request



Possible combination:  
Double- (736 Series) and triple-deck PCB terminal strips (737 Series) upon request



Possible combination:  
Double- (737 Series) and quadruple-deck PCB terminal strips (738 Series) upon request



Possible combination:  
Double- (737 Series) and quadruple-deck PCB terminal strips (738 Series) upon request

Marking



Testing



Testing via contact area above the conductors.