

Data Sheet | Item Number: 735-304

PCB terminal block; push-button; 1.5 mm²; Pin spacing 5 mm; 4-pole; PUSH WIRE®; 1,50 mm²; gray

<https://www.wago.com/735-304>



Color: ■ gray

Similar to illustration

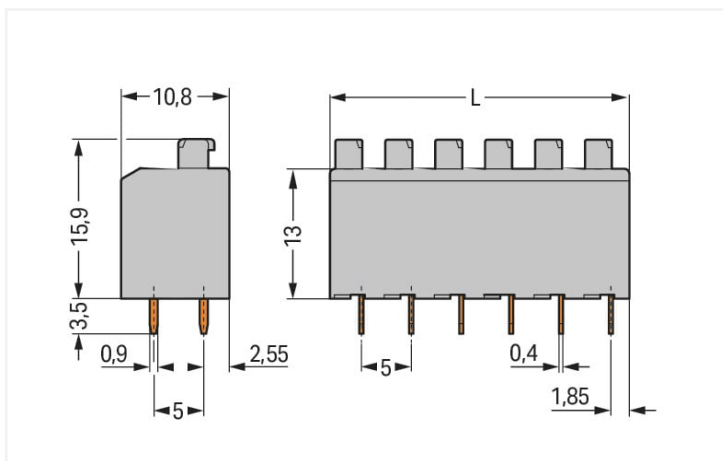
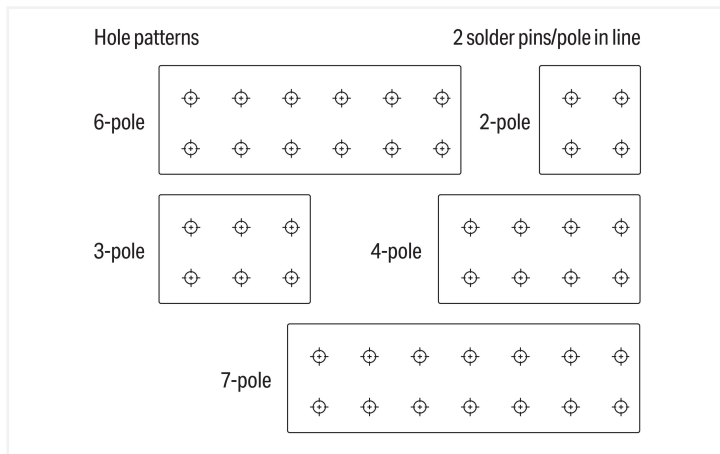

Dimensions in mm

- L (2-pole): 10 mm, L (3-pole): 15 mm
- L (4-pole): 20 mm, L (6-pole): 30 mm
- L (7-pole): 35 mm

- Compact PCB terminal blocks with push-buttons and PUSH WIRE® connection
- Top-of-unit, push-button actuation and conductor termination save space on the PCB
- Push-in termination of solid conductors
- Terminal blocks can be arranged side-by-side without loss of poles.

Notes	
Variants:	Direct marking Other versions (or variants) can be requested from WAGO Sales or configured at https://configurator.wago.com/ .

Electrical data							
Ratings per	IEC/EN 60664-1			Approvals per	UL 1059		
Overvoltage category	III	III	II	Use group	B	C	D
Pollution degree	3	2	2	Rated voltage	300 V	-	300 V
Nominal voltage	320 V	320 V	630 V	Rated current	10 A	-	10 A
Rated surge voltage	4 kV	4 kV	4 kV				
Rated current	10 A	10 A	10 A				

Approvals per	CSA		
	B	C	D
Use group	B	C	D
Rated voltage	300 V	-	300 V
Rated current	10 A	-	10 A

Connection data

Clamping units	4	Connection 1	
Total number of potentials	4	Connection technology	PUSH WIRE®
Number of connection types	1	Actuation type	Push-button
Number of levels	1	Solid conductor	0.5 ... 1.5 mm ² / 20 ... 16 AWG
		Fine-stranded conductor; with insulated ferrule	0.5 ... 1 mm ²
		Fine-stranded conductor; with uninsulated ferrule	0.5 ... 1 mm ²
		Strip length	8 ... 9 mm / 0.31 ... 0.35 inches
		Conductor connection direction to PCB	90 °
		Pole number	4

Physical data

Pin spacing	5 mm / 0.197 inches
Width	20 mm / 0.787 inches
Height	19.4 mm / 0.764 inches
Height from the surface	15.9 mm / 0.626 inches
Depth	10.8 mm / 0.425 inches
Solder pin length	3.5 mm
Solder pin dimensions	0.4 x 0.9 mm
Drilled hole diameter with tolerance	1 ^(+0.1) mm

PCB contact

PCB contact	THT
Solder pin arrangement	over the entire terminal strip (in-line)
Number of solder pins per potential	2

Material data

Note (material data)	Information on material specifications can be found here
Color	gray
Material group	I
Insulation material (main housing)	Polyamide (PA66)
Flammability class per UL94	V0
Clamping spring material	Chrome-nickel spring steel (CrNi)
Contact material	Electrolytic copper (E _{Cu})
Contact Plating	Tin
Fire load	0.053 MJ
Weight	3.4 g

Environmental requirements	
Limit temperature range	-60 ... +105 °C

Commercial data	
Product Group	4 (Printed Circuit Connectors)
eCl@ss 10.0	27-44-04-01
eCl@ss 9.0	27-44-04-01
ETIM 9.0	EC002643
ETIM 8.0	EC002643
PU (SPU)	240 (60) pcs
Packaging type	Box
Country of origin	CH
GTIN	4044918793070
Customs tariff number	85369010000

Environmental Product Compliance	
RoHS Compliance Status	Compliant, No Exemption

Approvals / Certificates

General approvals			Declarations of conformity and manufacturer's declarations		
Approval	Standard	Certificate Name	Approval	Standard	Certificate Name
CCA DEKRA Certification B.V.	EN 60947	2160584.30	EU-Declaration of Confor- mity WAGO GmbH & Co. KG	-	-
CCA DEKRA Certification B.V.	EN 60947	NTR NL-7132	UK-Declaration of Confor- mity WAGO GmbH & Co. KG	-	-
CSA DEKRA Certification B.V.	C22.2 No. 158	18677-47			
UL UL International Germany GmbH	UL 1977	E45171			
UR Underwriters Laboratories Inc.	UL 1059	E45172			

Downloads

Environmental Product Compliance	
Compliance Search	
Environmental Product Compliance 735-304	↓

Documentation

Additional Information			
Technical Section	03.04.2019	pdf 2027.26 KB	↓

CAD/CAE-Data

CAD data	CAE data
2D/3D Models 735-304 ↓	EPLAN Data Portal 735-304 ↓
	ZUKEN Portal 735-304 ↓

PCB Design















Symbol and Footprint via SamacSys 735-304 ↓
Symbol and Footprint via Ultra Librarian 735-304 ↓

1 Compatible Products

1.1 Optional Accessories

1.1.1 Ferrule

1.1.1.1 Ferrule

 Item No.: 216-241 Ferrule; Sleeve for 0.5 mm ² / 20 AWG; insulated; electro-tin plated; electrolytic copper; gastight crimped; acc. to DIN 46228, Part 4/09.90; white	 Item No.: 216-201 Ferrule; Sleeve for 0.5 mm ² / 20 AWG; insulated; electro-tin plated; white	 Item No.: 216-141 Ferrule; Sleeve for 0.5 mm ² / 20 AWG; un-insulated; electro-tin plated; electrolytic copper; gastight crimped; acc. to DIN 46228, Part 1/08.92	 Item No.: 216-101 Ferrule; Sleeve for 0.5 mm ² / AWG 22; un-insulated; electro-tin plated; silver-colored
 Item No.: 216-242 Ferrule; Sleeve for 0.75 mm ² / 18 AWG; insulated; electro-tin plated; electrolytic copper; gastight crimped; acc. to DIN 46228, Part 4/09.90; gray	 Item No.: 216-262 Ferrule; Sleeve for 0.75 mm ² / 18 AWG; insulated; electro-tin plated; electrolytic copper; gastight crimped; acc. to DIN 46228, Part 4/09.90; gray	 Item No.: 216-202 Ferrule; Sleeve for 0.75 mm ² / 18 AWG; insulated; electro-tin plated; gray	 Item No.: 216-142 Ferrule; Sleeve for 0.75 mm ² / 18 AWG; un-insulated; electro-tin plated; electrolytic copper; gastight crimped; acc. to DIN 46228, Part 1/08.92
 Item No.: 216-102 Ferrule; Sleeve for 0.75 mm ² / AWG 20; un-insulated; electro-tin plated; silver-colored	 Item No.: 216-243 Ferrule; Sleeve for 1 mm ² / AWG 18; insulated; electro-tin plated; electrolytic copper; gastight crimped; acc. to DIN 46228, Part 4/09.90; red	 Item No.: 216-263 Ferrule; Sleeve for 1 mm ² / AWG 18; insulated; electro-tin plated; electrolytic copper; gastight crimped; acc. to DIN 46228, Part 4/09.90; red	 Item No.: 216-203 Ferrule; Sleeve for 1 mm ² / AWG 18; insulated; electro-tin plated; red
 Item No.: 216-103 Ferrule; Sleeve for 1 mm ² / AWG 18; un-insulated; electro-tin plated	 Item No.: 216-143 Ferrule; Sleeve for 1 mm ² / AWG 18; un-insulated; electro-tin plated; electrolytic copper; gastight crimped; acc. to DIN 46228, Part 1/08.92		

1.1.2 Marking

1.1.2.1 Marking strip



Item No.: 210-332/500-202

Marking strips; as a DIN A4 sheet; MARKED; 1-16 (160x); Height of marker strip: 3 mm; Strip length 182 mm; Horizontal marking; Self-adhesive; white



Item No.: 210-332/500-205

Marking strips; as a DIN A4 sheet; MARKED; 1-32 (80x); Height of marker strip: 3 mm; Strip length 182 mm; Horizontal marking; Self-adhesive; white



Item No.: 210-332/500-204

Marking strips; as a DIN A4 sheet; MARKED; 17-32 (160x); Height of marker strip: 3 mm; Strip length 182 mm; Horizontal marking; Self-adhesive; white



Item No.: 210-332/500-206

Marking strips; as a DIN A4 sheet; MARKED; 33-48 (160x); Height of marker strip: 3 mm; Strip length 182 mm; Horizontal marking; Self-adhesive; white

1.1.3 Test and measurement

1.1.3.1 Testing accessories



Item No.: 735-500

WAGO Test pin; 1 mm Ø; 30 V AC / 60 V DC; CAT0; 1 A; 6 mm uninsulated; Test lead for soldering up to 0,5mm²

1.1.4 Tool

1.1.4.1 Operating tool



Item No.: 210-719

Operating tool; Blade: 2.5 x 0.4 mm; with a partially insulated shaft



Item No.: 210-647

Operating tool; Blade: 2.5 x 0.4 mm; with a partially insulated shaft; multicoloured

Installation Notes

Conductor termination

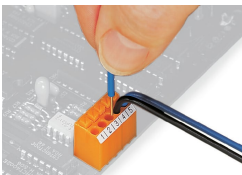

Insert solid conductors via push-in termination.

Conductor removal

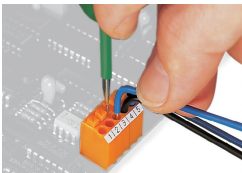

Removing a conductor via push-button.

Installation



Terminal blocks can be arranged side-by-side without loss of poles.

Testing

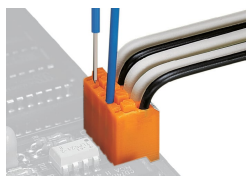

Testing via 1 mm Ø test pin.