

Data Sheet | Item Number: 733-110

1-conductor female connector; CAGE CLAMP®; 0.5 mm²; Pin spacing 2.5 mm; 10-pole; 100% protected against mismatching; 0,50 mm²; light gray

<https://www.wago.com/733-110>



Color: ■ light gray

Similar to illustration

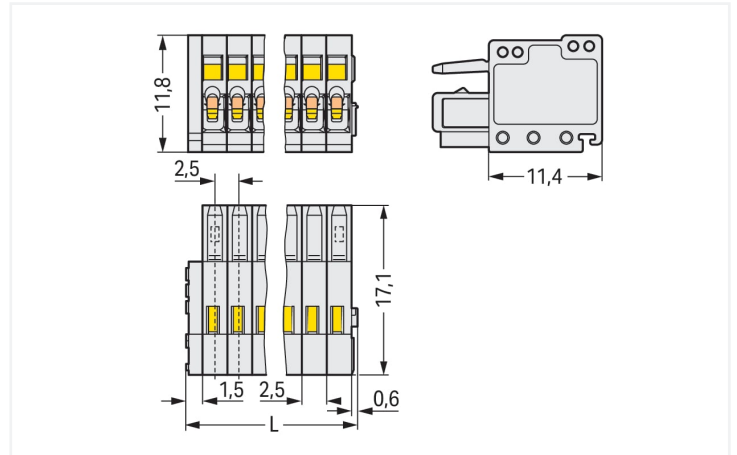

Dimensions in mm

$L = (\text{pole no.} \times \text{pin spacing}) + 2.1 \text{ mm}$

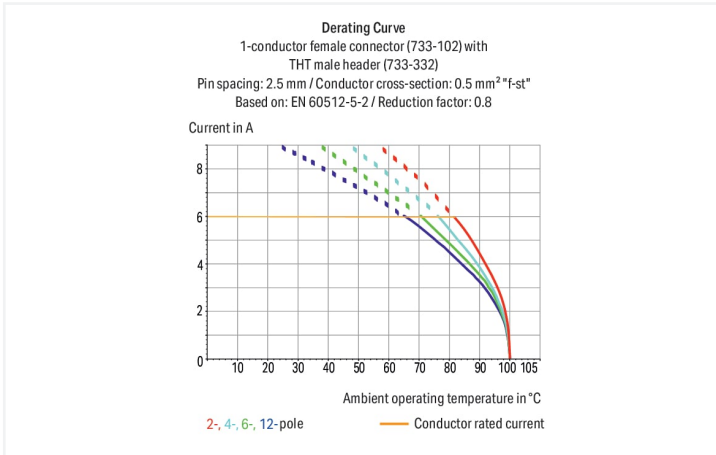

- Universal connection for all conductor types
- Easy cable pre-assembly and on-unit wiring via vertical and horizontal CAGE CLAMP® actuation
- Strain relief plates for factory and field assembly
- 100% protected against mismatching
- Coding option available

Notes

Safety Information

The MCS – MULTI CONNECTION SYSTEM includes connectors without breaking capacity in accordance with DIN EN 61984. When used as intended, these connectors must not be connected/disconnected when live or under load. When used as intended, these connectors must not be connected/disconnected when live or under load. The circuit design should ensure header pins, which can be touched, are not live when unmated.

Variants:

Other pole numbers

Gold-plated or partially gold-plated contact surfaces

Other versions (or variants) can be requested from WAGO Sales or configured at <https://configurator.wago.com/>.

Electrical data

Ratings per	IEC/EN 60664-1		
Overvoltage category	III	III	II
Pollution degree	3	2	2
Nominal voltage	100 V	160 V	320 V
Rated surge voltage	2.5 kV	2.5 kV	2.5 kV
Rated current	6 A	6 A	6 A

Approvals per	UL 1059		
Use group	B	C	D
Rated voltage	150 V	-	-
Rated current	4 A	-	-

Approvals per	CSA		
Use group	B	C	D
Rated voltage	150 V	-	-
Rated current	4 A	-	-

Connection data

Clamping units	10
Total number of potentials	10
Number of connection types	1
Number of levels	1

Connection 1	
Connection technology	CAGE CLAMP®
Actuation type	Operating tool
Actuation direction 1	Operation parallel to conductor entry
Actuation direction 2	Operation perpendicular to conductor entry
Solid conductor	0.08 ... 0.5 mm ² / 28 ... 20 AWG
Fine-stranded conductor	0.08 ... 0.5 mm ² / 28 ... 20 AWG
Fine-stranded conductor; with insulated ferrule	0.25 ... 0.34 mm ²
Fine-stranded conductor; with uninsulated ferrule	0.25 ... 0.34 mm ²
Strip length	5 ... 6 mm / 0.2 ... 0.24 inches
Pole number	10
Conductor entry direction to mating direction	0°

Physical data

Pin spacing	2.5 mm / 0.098 inches
Width	27.1 mm / 1.067 inches
Height	11.8 mm / 0.465 inches
Depth	17.1 mm / 0.673 inches

Mechanical data

Variable coding	Yes
Anti-rotation protection	Yes

Plug-in connection

Contact type (pluggable connector)	Female connector/socket
Connector (connection type)	for conductor
Mismatching protection	Yes

Material data

Note (material data)	Information on material specifications can be found here
Color	light gray
Material group	I
Insulation material (main housing)	Polyamide (PA66)
Flammability class per UL94	V0
Clamping spring material	Chrome-nickel spring steel (CrNi)
Contact material	Copper alloy
Contact Plating	Tin
Fire load	0.076 MJ
Weight	4.4 g

Environmental requirements

Limit temperature range	-60 ... +100 °C	Environmental Testing (Environmental Conditions)	
Processing temperature	-35 ... +60 °C	Test specification	DIN EN 50155 (VDE 0115-200):2022-06
		Railway applications – Rolling stock – Electronic equipment	
		Test procedure	DIN EN 61373 (VDE 0115-0106):2011-04
		Railway applications – Rolling stock equipment – Shock and vibration tests	
		Spectrum/Installation location	Service life test, Category 1, Class A/B
		Function test with noise-like vibration	Test passed according to Section 8 of the standard
		Frequency	$f_1 = 5 \text{ Hz}$ to $f_2 = 150 \text{ Hz}$ $f_1 = 5 \text{ Hz}$ to $f_2 = 150 \text{ Hz}$
		Acceleration	0.101g (highest test level used for all axes) 0.572g (highest test level used for all axes) 5g (highest test level used for all axes)
		Test duration per axis	10 min. 5 h
		Test directions	X, Y and Z axes X, Y and Z axes X, Y and Z axes
		Monitoring for contact faults/interruptions	Passed
		Voltage drop measurement before and after each axis	Passed
		Simulated service life test through increased levels of noise-like vibration	Test passed according to Section 9 of the standard
		Extended test scope: Monitoring for contact faults/interruptions	Passed
		Extended test scope: Voltage drop measurement before and after each axis	Passed
		Shock test	Test passed according to Section 10 of the standard
		Shock form	Half sine
		Shock duration	30 ms
		Number of shocks per axis	3 pos. und 3 neg.
		Vibration and shock stress for rolling stock equipment	Passed

Commercial data

Product Group	3 (Multi Conn. System)
eCl@ss 10.0	27-44-03-09
eCl@ss 9.0	27-44-03-09
ETIM 9.0	EC002638
ETIM 8.0	EC002638
PU (SPU)	100 pcs
Packaging type	Box
Country of origin	DE
GTIN	4044918294201
Customs tariff number	85366990990

Environmental Product Compliance

RoHS Compliance Status	Compliant, No Exemption
------------------------	-------------------------

Approvals / Certificates

General approvals



Approval	Standard	Certificate Name
CCA DEKRA Certification B.V.	EN 61984	2169534.01
CCA DEKRA Certification B.V.	IEC 61984	NL-31141
CSA DEKRA Certification B.V.	C22.2	1465035
UL UL International Germany GmbH	UL 1977	E45171
UL Underwriters Laboratories Inc.	UL 1059	E45172

Declarations of conformity and manufacturer's declarations



Approval	Standard	Certificate Name
Railway WAGO GmbH & Co. KG	-	Railway Ready

Approvals for marine applications



Approval	Standard	Certificate Name
ABS American Bureau of Shipping	-	19-HG1869876-PDA
DNV DNV GL SE	-	TAE000016Z
LR Lloyds Register	IEC 61984	96/20035 (E5)

Downloads

Environmental Product Compliance

Compliance Search

Environmental Product Compliance 733-110



Documentation

Additional Information

Technical Section

03.04.2019

pdf

2027.26 KB



CAD/CAE-Data

CAD data

2D/3D Models 733-110



CAE data

EPLAN Data Portal 733-110



ZUKEN Portal 733-110



1 Compatible Products

1.1 System counterpart

1.1.1 Male connector/plug



Item No.: 733-210

1-conductor male connector; CAGE CLAMP®; 0.5 mm²; Pin spacing 2.5 mm; 10-pole; 100% protected against mismatching; 0,50 mm²; light gray



Item No.: 733-210/034-000

1-conductor male connector; CAGE CLAMP®; 0.5 mm²; Pin spacing 2.5 mm; 10-pole; 100% protected against mismatching; Strain relief plate; 0,50 mm²; light gray



Item No.: 733-370/105-604/997-406

THR male header; 0.8 x 0.8 mm solder pin; angled; 100% protected against mismatching; in tape-and-reel packaging; Pin spacing 2.5 mm; 10-pole; black



Item No.: 733-370/105-604

THR male header; 0.8 x 0.8 mm solder pin; angled; 100% protected against mismatching; Pin spacing 2.5 mm; 10-pole; black



Item No.: 733-340/105-604/997-446

THR male header; 0.8 x 0.8 mm solder pin; straight; 100% protected against mismatching; in tape-and-reel packaging; Pin spacing 2.5 mm; 10-pole; black



Item No.: 733-340/105-604

THR male header; 0.8 x 0.8 mm solder pin; straight; 100% protected against mismatching; Pin spacing 2.5 mm; 10-pole; black



Item No.: 733-370

THT male header; 0.8 x 0.8 mm solder pin; angled; 100% protected against mismatching; Pin spacing 2.5 mm; 10-pole; light gray



Item No.: 733-340

THT male header; 0.8 x 0.8 mm solder pin; straight; 100% protected against mismatching; Pin spacing 2.5 mm; 10-pole; light gray

1.2 Optional Accessories

1.2.1 Ferrule

1.2.1.1 Ferrule



Item No.: 216-301

Ferrule; Sleeve for 0.25 mm² / AWG 24; insulated; electro-tin plated; yellow



Item No.: 216-321

Ferrule; Sleeve for 0.25 mm² / AWG 24; insulated; electro-tin plated; yellow



Item No.: 216-151

Ferrule; Sleeve for 0.25 mm² / AWG 24; uninsulated; electro-tin plated



Item No.: 216-131

Ferrule; Sleeve for 0.25 mm² / AWG 24; uninsulated; electro-tin plated; silver-colored



Item No.: 216-302

Ferrule; Sleeve for 0.34 mm² / 22 AWG; insulated; electro-tin plated; light turquoise



Item No.: 216-322

Ferrule; Sleeve for 0.34 mm² / 22 AWG; insulated; electro-tin plated; light turquoise



Item No.: 216-132

Ferrule; Sleeve for 0.34 mm² / AWG 24; uninsulated; electro-tin plated



Item No.: 216-152

Ferrule; Sleeve for 0.34 mm² / AWG 24; uninsulated; electro-tin plated

1.2.2 Marking

1.2.2.1 Marking strip



Item No.: 210-331/250-202

Marking strips; as a DIN A4 sheet; MARKED; 1-16 (400x); Height of marker strip: 2.3 mm/0.091 in; Strip length 182 mm; Horizontal marking; Self-adhesive; white



Item No.: 210-331/250-207

Marking strips; as a DIN A4 sheet; MARKED; 1-48 (100x); Height of marker strip: 2.3 mm/0.091 in; Strip length 182 mm; Horizontal marking; Self-adhesive; white



Item No.: 210-331/250-204

Marking strips; as a DIN A4 sheet; MARKED; 17-32 (400x); Height of marker strip: 2.3 mm/0.091 in; Strip length 182 mm; Horizontal marking; Self-adhesive; white



Item No.: 210-331/250-206

Marking strips; as a DIN A4 sheet; MARKED; 33-48 (400x); Height of marker strip: 2.3 mm/0.091 in; Strip length 182 mm; Horizontal marking; Self-adhesive; white

1.2.3 Strain relief

1.2.3.1 Strain relief plate



Item No.: 734-129

Strain relief plate; for female and male connectors; 25 mm wide; 1 part; Pin spacing 3.5 mm; light gray

1.2.4 Test and measurement

1.2.4.1 Testing accessories



Item No.: 735-500

WAGO Test pin; 1 mm Ø; 30 V AC / 60 V DC; CAT0; 1 A; 6 mm uninsulated; Test lead for soldering up to 0,5mm²

1.2.5 Tool

1.2.5.1 Operating tool



Item No.: 210-719

Operating tool; Blade: 2.5 x 0.4 mm; with a partially insulated shaft



Item No.: 210-251

Operating tool; for MCS MICRO and MINI with CAGE CLAMP® connection; yellow



Item No.: 233-335

Operating tool; green



Item No.: 233-331

Operating tool; insulated; yellow



Item No.: 733-130

Operating tool; made of insulating material; 1-way; loose; white



Item No.: 733-191

Operating tool; made of insulating material; 1-way; loose; yellow



Item No.: 233-332

Operating tool; made of insulating material; white

Installation Notes

Mismatching protection

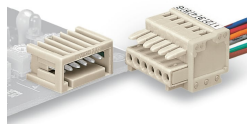

Male headers and female connectors are 100% protected against mismatching. Only mating halves with the same pole number can be connected.

Conductor termination

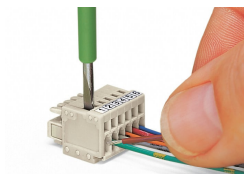

Inserting conductor via (2.5 x 0.4) mm screwdriver – CAGE CLAMP® actuation perpendicular to conductor entry.

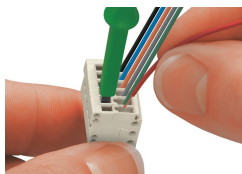

Conductor termination via screwdriver (233-335) – parallel to CAGE CLAMP® actuation

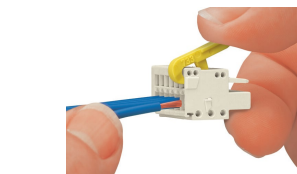
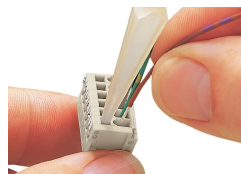

Conductor termination via operating tool (733-191)

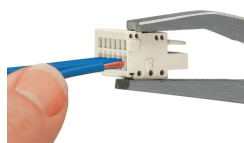

Conductor termination via operating tool (210-251)

Coding

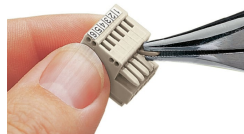

Coding a female connector – removing coding finger(s).

Marking

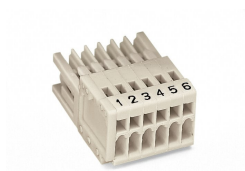

Strain relief

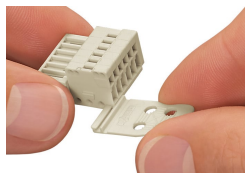

Strain relief plates for factory or in-the-field assembly

Testing

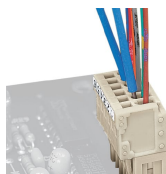

Testing via 1 mm Ø test pin (735-500), touch contact.