

### 600V / 15A 6 in one-package

#### ■ Features

- Compact Single in -line package

#### ■ Applications

- Inverter for Motor drive
- AC and DC Servo drive amplifier
- Uninterruptible power supply
- Industrial machines, such as Welding machines



#### ■ Maximum ratings and characteristics

- Absolute maximum ratings (at  $T_c=25^\circ\text{C}$  unless otherwise specified)

Item	Symbol	Rating	Unit
Collector-Emitter voltage	$V_{CES}$	600	V
Gate-Emitter voltage	$V_{GES}$	$\pm 20$	V
Collector current	Continuous	$I_C$	15 A
	1ms	$I_C$ pulse	30 A
		$-I_C$	15 A
	1ms	$-I_C$ pulse	30 A
Max. power dissipation	$P_C$	60	W
Operating temperature	$T_j$	+150	$^\circ\text{C}$
Storage temperature	$T_{stg}$	-40 to +125	$^\circ\text{C}$
Isolation voltage	$V_{is}$	AC 2000 (1min.)	V
Screw torque	Mounting *1	1.7	N·m

\*1 : Recommendable value : 1.3 to 1.7 N·m (M4)

#### ■ Equivalent Circuit Schematic

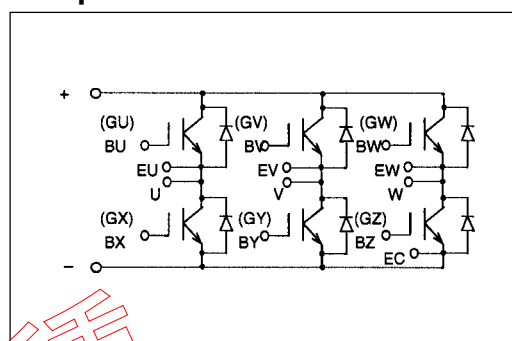

- Electrical characteristics (at  $T_j=25^\circ\text{C}$  unless otherwise specified)

Item	Symbol	Characteristics			Conditions	Unit
		Min.	Typ.	Max.		
Zero gate voltage collector current	$I_{CES}$	–	–	1.0	$V_{GE}=0\text{V}$ , $V_{CE}=600\text{V}$	mA
Gate-Emitter leakage current	$I_{GES}$	–	–	0.1	$V_{CE}=0\text{V}$ , $V_{GE}=\pm 20\text{V}$	$\mu\text{A}$
Gate-Emitter threshold voltage	$V_{GE(th)}$	5.5	–	8.5	$V_{CE}=20\text{V}$ , $I_C=15\text{mA}$	V
Collector-Emitter saturation voltage	$V_{CE(sat)}$	–	–	2.8	$V_{GE}=15\text{V}$ , $I_C=15\text{A}$	V
Input capacitance	$C_{ies}$	–	975	–	$V_{GE}=0\text{V}$	pF
Output capacitance	$C_{oes}$	–	225	–	$V_{CE}=10\text{V}$	
Reverse transfer capacitance	$C_{res}$	–	54	–	$f=1\text{MHz}$	
Turn-on time	$t_{on}$	–	–	1.2	$V_{CC}=300\text{V}$	
Turn-off time	$t_r$	–	–	1.0	$I_C=15\text{A}$	$\mu\text{s}$
	$t_{off}$	–	–	1.0	$V_{GE}=\pm 15\text{V}$	
	$t_f$	–	–	0.35	$R_G=150\text{ohm}$	
Diode forward on voltage	$V_F$	–	–	3.0	$I_F=15\text{A}$ , $V_{GE}=0\text{V}$	V
Reverse recovery time	$t_{rr}$	–	–	0.3	$I_F=15\text{A}$ , $-di/dt=45\text{A}/\mu\text{s}$ , $V_{GE}=-10\text{V}$	$\mu\text{s}$

#### ● Thermal resistance characteristics

Item	Symbol	Characteristics			Conditions	Unit
		Min.	Typ.	Max.		
Thermal resistance	$R_{th(j-c)}$	–	–	2.08	IGBT	$^\circ\text{C}/\text{W}$
	$R_{th(j-c)}$	–	–	3.0	Diode	$^\circ\text{C}/\text{W}$
	$R_{th(c-f)*2}$	–	0.06	–	the base to cooling fin	$^\circ\text{C}/\text{W}$

\*2 : This is the value which is defined mounting on the additional cooling fin with thermal compound

Characteristics (Representative)

Collector current vs. Collector-Emitter voltage  
T<sub>J</sub>=25°C

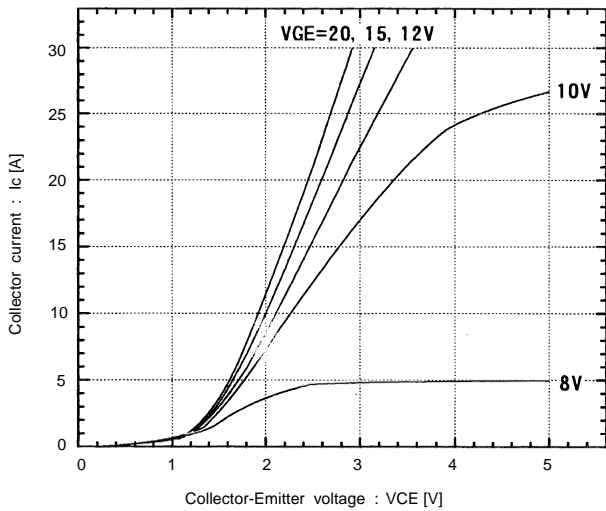

Collector current vs. Collector-Emitter voltage  
T<sub>J</sub>=125°C

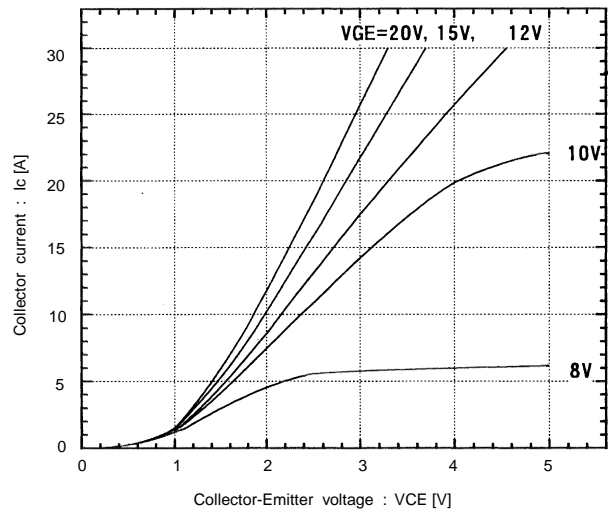

Collector-Emitter vs. Gate-Emitter voltage  
T<sub>J</sub>=25°C

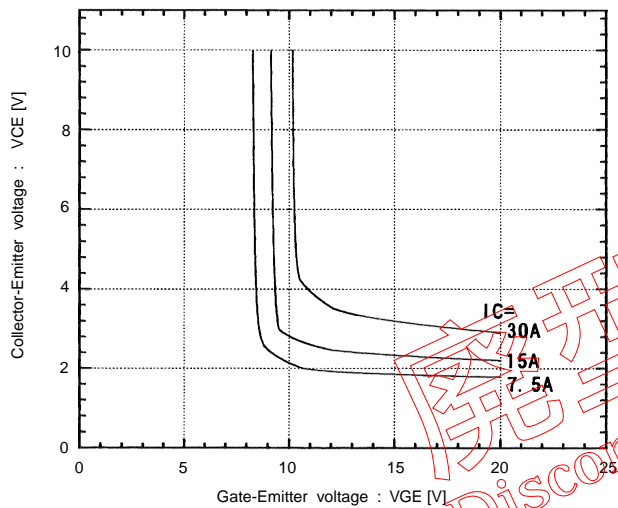

Collector-Emitter vs. Gate-Emitter voltage  
T<sub>J</sub>=125°C

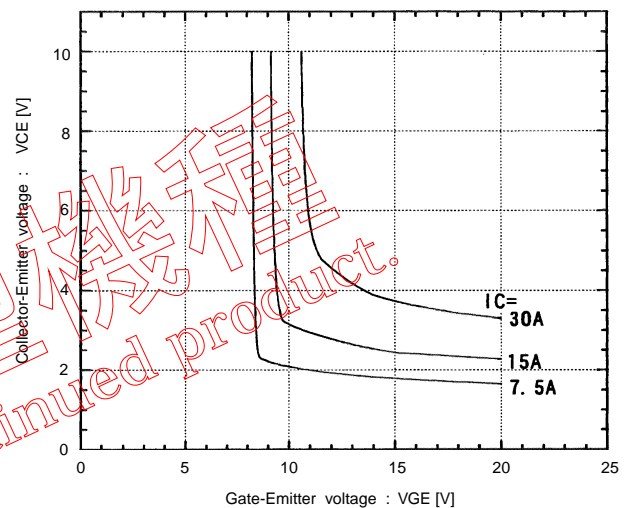

Switching time vs. Collector current  
V<sub>CC</sub>=300V, R<sub>G</sub>=150 ohm, V<sub>GE</sub>=±15V, T<sub>J</sub>=25°C

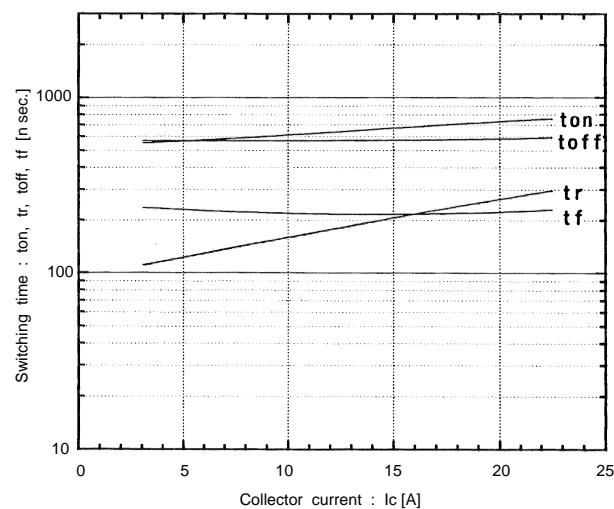

Switching time vs. Collector current  
V<sub>CC</sub>=300V, R<sub>G</sub>=150 ohm, V<sub>GE</sub>=±15V, T<sub>J</sub>=125°C

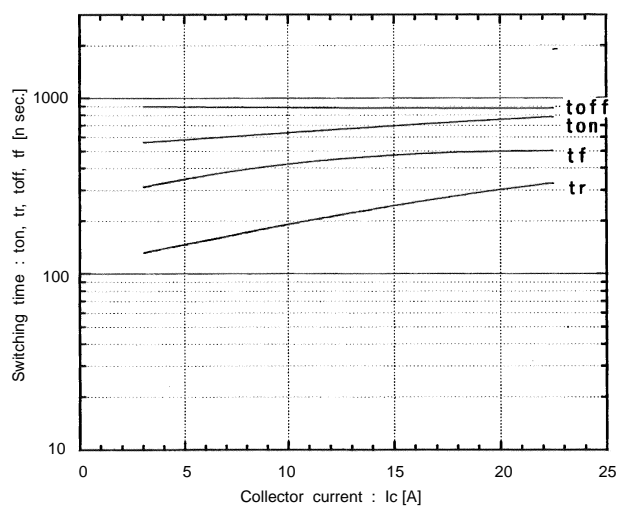

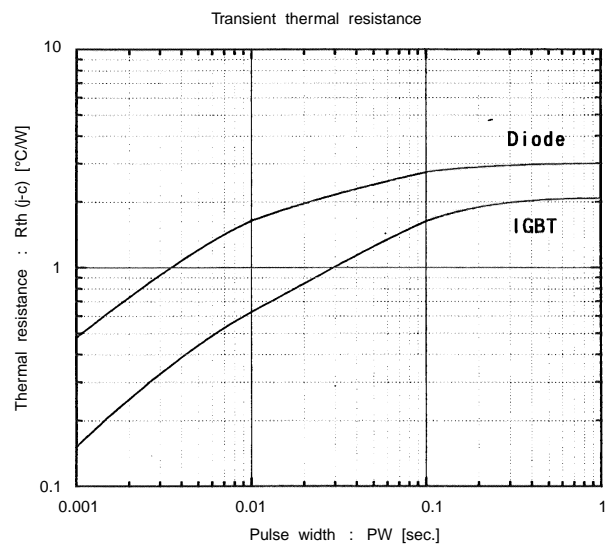
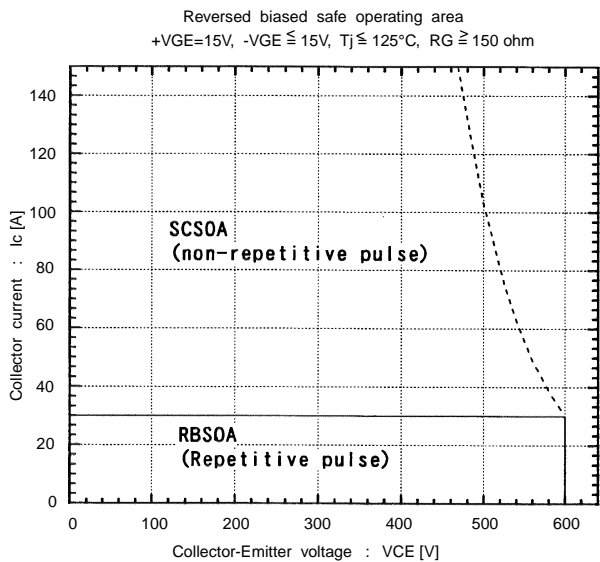
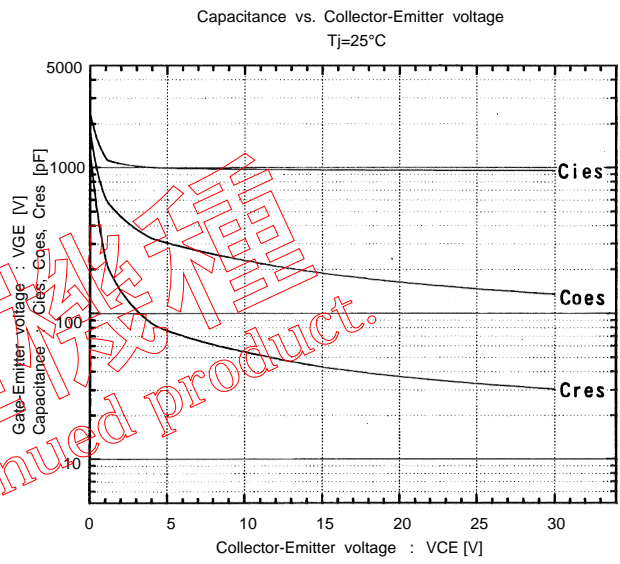
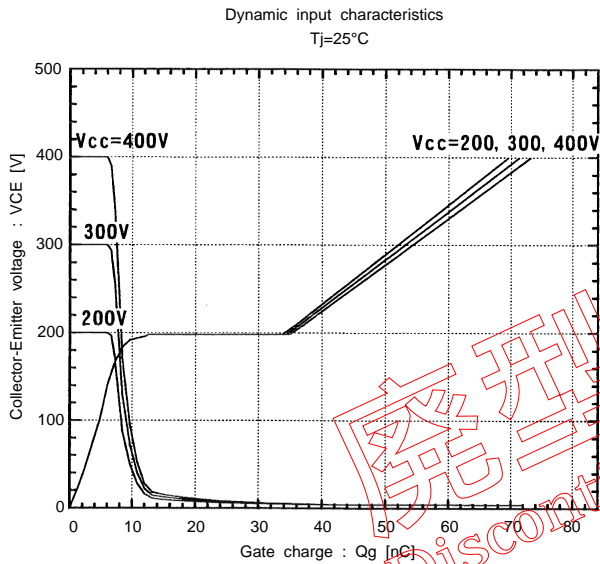
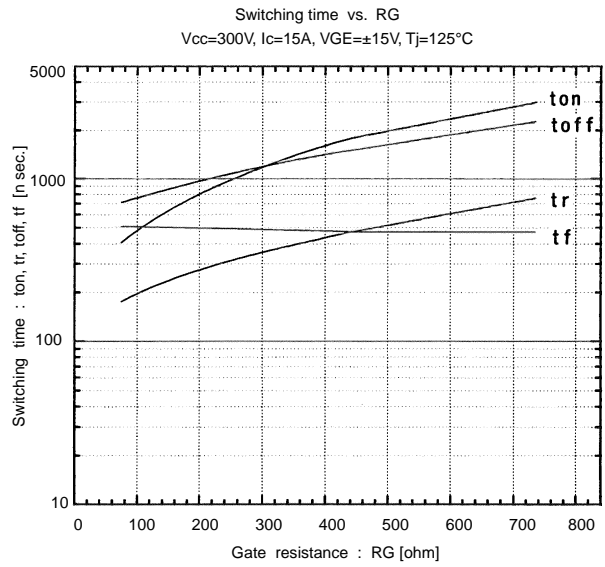
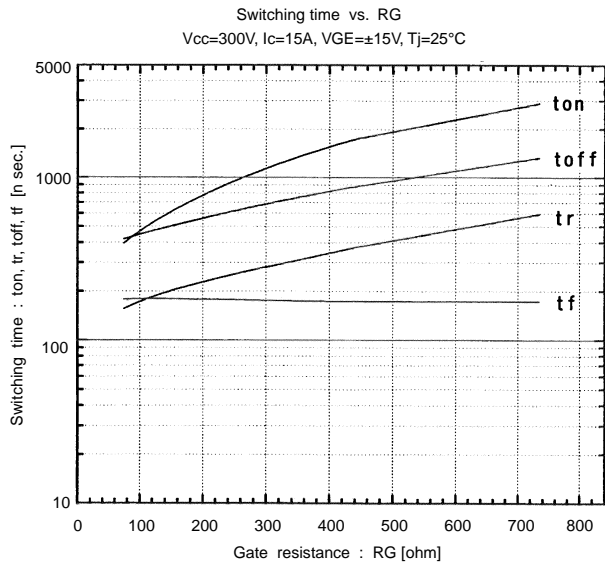

Switching loss vs. Collector current  
 $V_{cc}=300V, R_G=150\ \text{ohm}, V_{GE}=\pm 15V, T_j=125^\circ\text{C}$

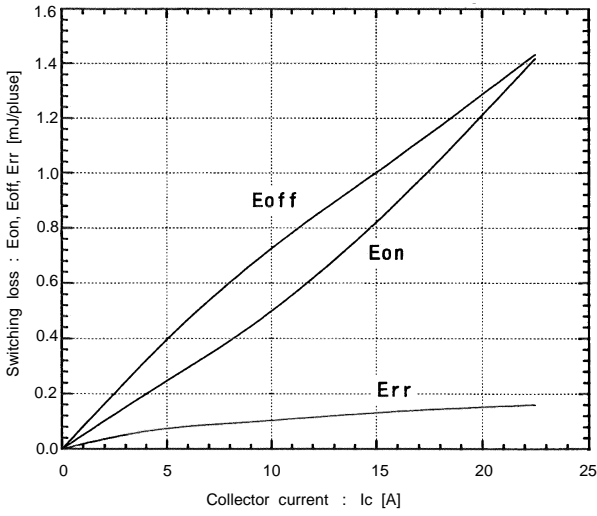

Switching loss vs. Gate resistance  
 $V_{cc}=300V, I_c=15A, V_{GE}=\pm 15V, T_j=125^\circ\text{C}$

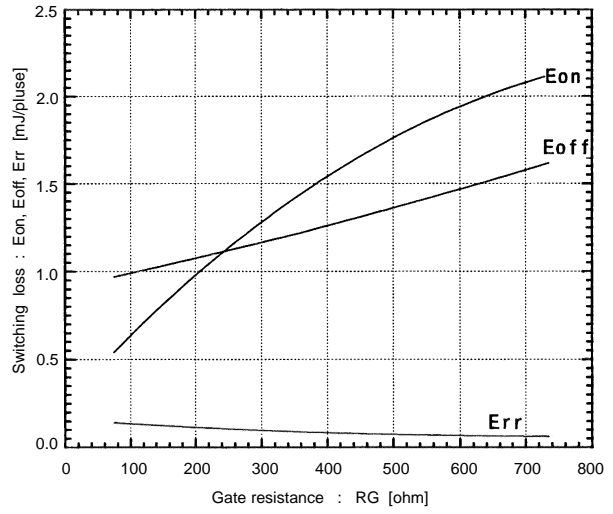

Forward current vs. Forward voltage

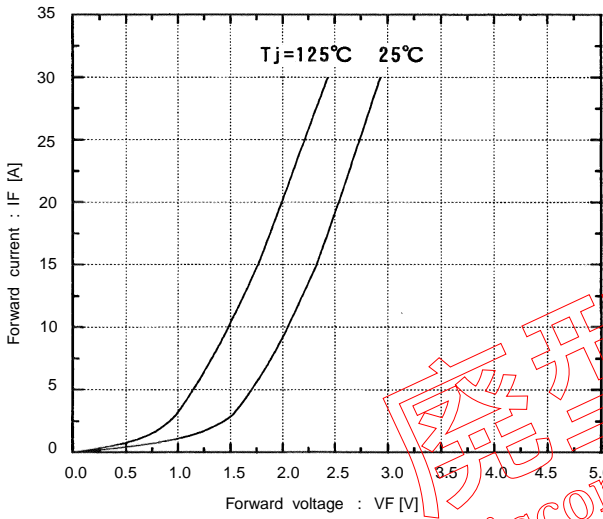

Reverse recovery characteristics  
 $t_{rr}, I_{rr}$ , vs.  $I_F$

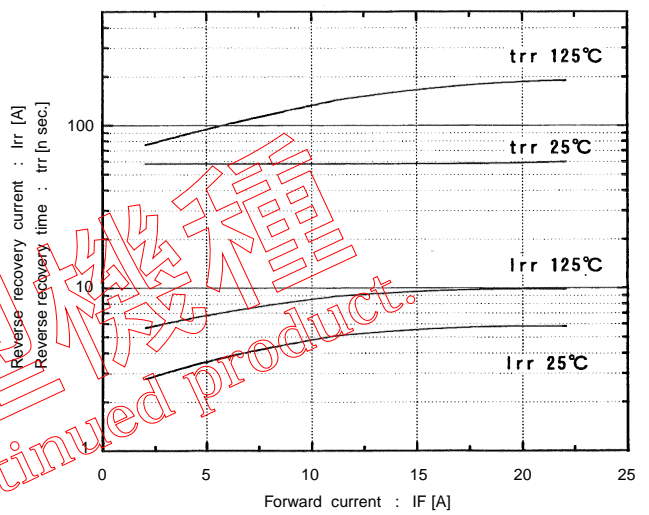

■ Outline Drawings, mm

