

PIDG

TE Internal #: 696422-6

Closed Ring Tongue Terminal, 22 – 16 AWG, #10 Stud Size, .197 in Stud Diameter, Closed Barrel, Straight, Tin, Partially Insulated, PIDG

[View on TE.com >](#)

Terminals & Splices > Ring Terminals

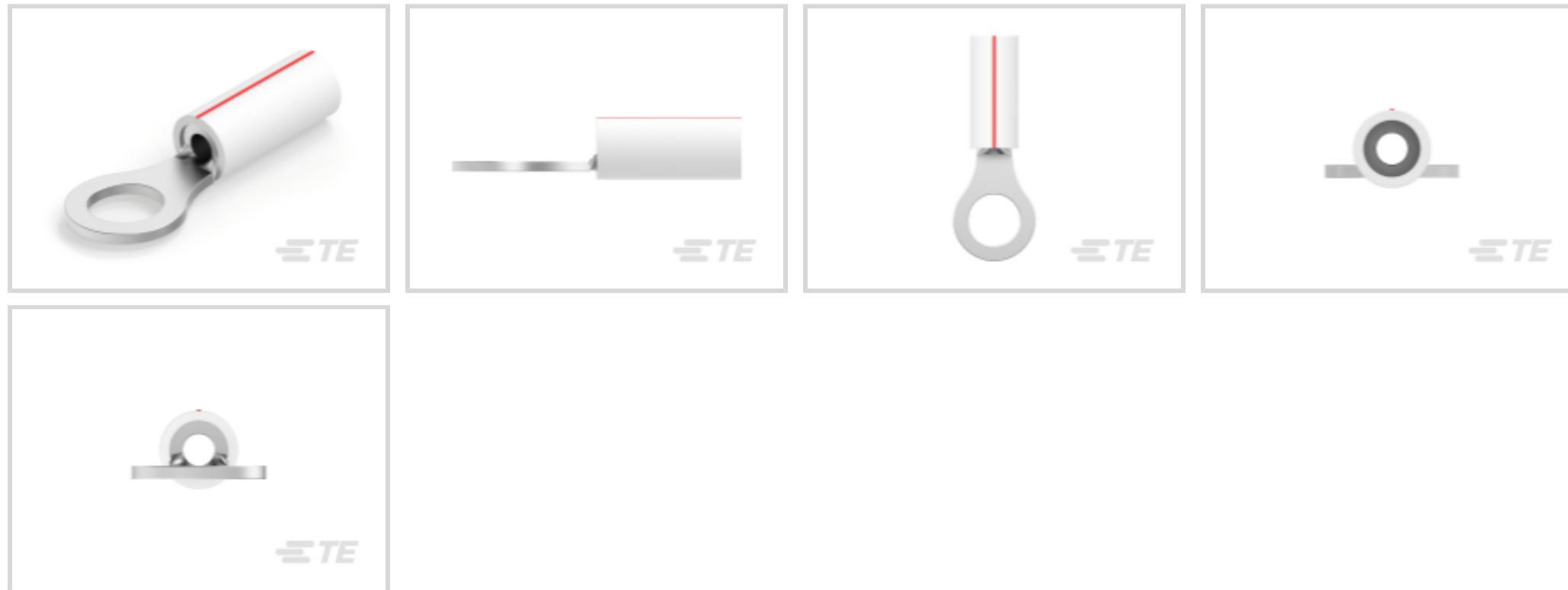

Ring Terminal Product Type: Closed Ring Tongue Terminal

Wire Size: 509 – 3260 CMA

Stud Size: #10

Features

Product Type Features

Terminal Features	Sheared
Ring Terminal Product Type	Closed Ring Tongue Terminal
Stud Size	#10
Sealable	No
Wire Insulation Support Retention Type	Insulation Support

Configuration Features

Number of Holes	1
-----------------	---

Body Features

Product Weight	.895 g
Insulation Sleeve Color	Natural
Stripe Color	Red

Contact Features

Barrel Type	Closed
Terminal Orientation	Straight
Terminal Plating Material	Tin

Mechanical Attachment



Wire Insulation Support	With
-------------------------	------

Dimensions

	.197 in
Wire Size	509 – 3260 CMA
Tongue Thickness	.79 mm[.031 in]
Product Length	21.56 mm[.849 in]
Compatible Insulation Diameter (Max)	3.18 mm[.125 in]
Compatible Insulation Diameter Range	2.03 – 3.18 mm[.08 – .125 in]

Usage Conditions

Insulation Option	Partially Insulated
Operating Temperature Range	150 °C[302 °F]

Operation/Application

Compatible With Wire Base Material	Copper
Compatible With Wire Plating Material	Tin

Industry Standards

Government Qualified Terminal	No
-------------------------------	----

Packaging Features

Packaging Quantity	1000
Packaging Method	Loose Piece

Other

Terminals & Splices Comment	Marking: Commercial 22-16- Military 22-18 in accordance with MIL-T-7928.
-----------------------------	--

Product Compliance

[For compliance documentation, visit the product page on TE.com>](#)

EU RoHS Directive 2011/65/EU	Compliant
EU ELV Directive 2000/53/EC	Compliant
China RoHS 2 Directive MIIT Order No 32, 2016	No Restricted Materials Above Threshold
EU REACH Regulation (EC) No. 1907/2006	Current ECHA Candidate List: JUNE 2023 (235) Candidate List Declared Against: JUNE 2023 (235) Does not contain REACH SVHC
Halogen Content	Not Low Halogen - contains Br or Cl > 900

ppm.

Solder Process Capability

Not applicable for solder process capability

Product Compliance Disclaimer

This information is provided based on reasonable inquiry of our suppliers and represents our current actual knowledge based on the information they provided. This information is subject to change. The part numbers that TE has identified as EU RoHS compliant have a maximum concentration of 0.1% by weight in homogenous materials for lead, hexavalent chromium, mercury, PBB, PBDE, DBP, BBP, DEHP, DIBP, and 0.01% for cadmium, or qualify for an exemption to these limits as defined in the Annexes of Directive 2011/65/EU (RoHS2). Finished electrical and electronic equipment products will be CE marked as required by Directive 2011/65/EU. Components may not be CE marked. Additionally, the part numbers that TE has identified as EU ELV compliant have a maximum concentration of 0.1% by weight in homogenous materials for lead, hexavalent chromium, and mercury, and 0.01% for cadmium, or qualify for an exemption to these limits as defined in the Annexes of Directive 2000/53/EC (ELV). Regarding the REACH Regulation, the information TE provides on SVHC in articles for this part number is based on the latest European Chemicals Agency (ECHA) 'Guidance on requirements for substances in articles' posted at this URL: <https://echa.europa.eu/guidance-documents/guidance-on-reach>

Compatible Parts

REPRESENTATION ONLY

TE Part # 47386
DAHT PG PIDG 26-16 ASSY

TE Part # 59250
T-HEAD PIDG 26-14 ASSY

TE Part # 58423-1
DIE, RBY IS9252

TE Part # 59824-1
TETRA-CRIMP PIDG PG FASTON 22-10 ASSY

TE Part # 58433-3
PRO CR ASSY, RBY IS9252

TE Part # 539691-2
ERGO DIE R.B.Y

TE Part # 2063030-1
SDE DIESET, RBY, UL

TE Part # 47806-2
DIES PIDG 22-16 DIE SET

TE Part # 59300
T-HEAD PIDG PG 26-16 ASSY

TE Part # 169400
CERTI-LOK FRAME W/O DIES

TE Part # 169404
CERTI-LOK DIE

TE Part # 1SET191001R0000
CRIMP-HT



TE Part # 1SET191002R0000
TET CRIMP-HT

Also in the Series | PIDG



Compression Connectors(17)



Crimp Terminal Housings(1)



Crimp Wire Pins, Tabs & Ferrules(41)



Hand Crimping Tools(2)



Knife Disconnects(11)



PCB Terminals(7)

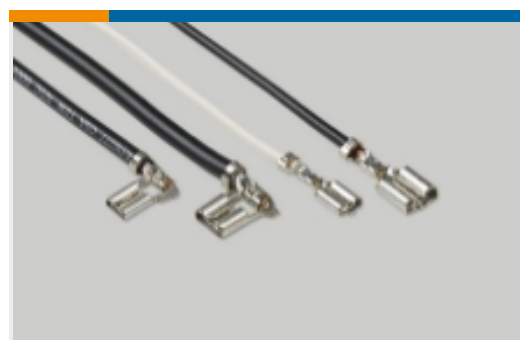

Quick Disconnects(47)



Ring Terminals(598)

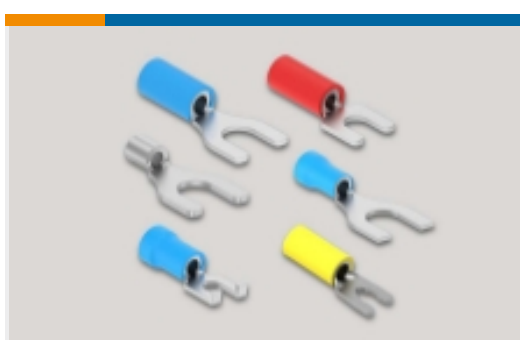

Spade Terminals(231)



Special Purpose Terminals(1)



Splices(43)

Customers Also Bought



TE Part #2-6609028-0
30VK6=F7358 S0



TE Part #1625862-1
RH73 2A 10G 30% 1000PPM 1K RL



TE Part #32858
TERMINAL,BUDG R 26-22 6

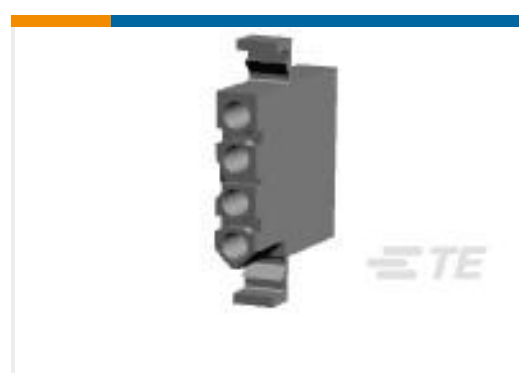

TE Part #770329-1
04P .093 COMM P&S RECPT .250CL

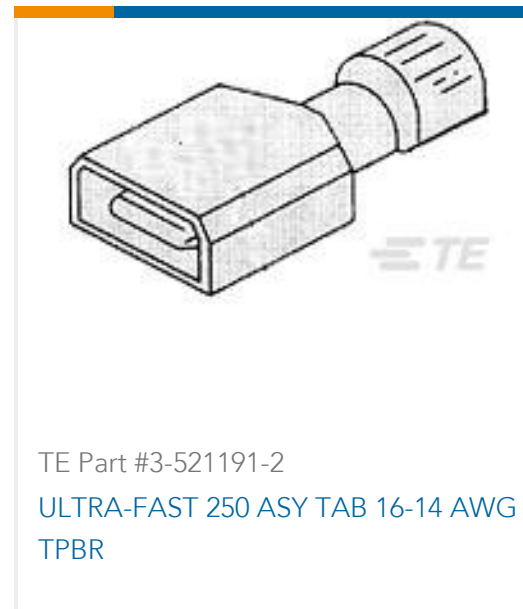
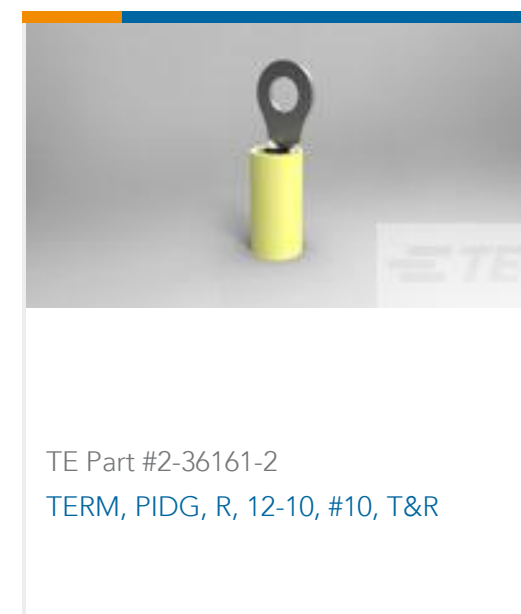
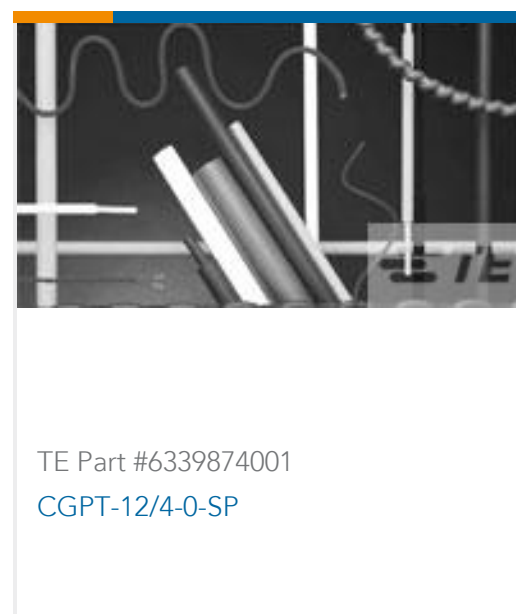

Documents

Product Drawings

[PIDG PVF2 22-16COMM22-18MIL 10](#)

English

CAD Files

[3D PDF](#)

3D

Customer View Model

[ENG_CVM_CVM_696422-6_A.2d_dxf.zip](#)

English

Customer View Model

[ENG_CVM_CVM_696422-6_A.3d_igs.zip](#)

English

Customer View Model

[ENG_CVM_CVM_696422-6_A.3d_stp.zip](#)

English

By downloading the CAD file I accept and agree to the [Terms and Conditions](#) of use.

Datasheets & Catalog Pages

[RADIATION_RESISTANT_PRE-INSULATED_TERMINALS_SPLICES](#)

English

Product Specifications

[Application Specification](#)

English