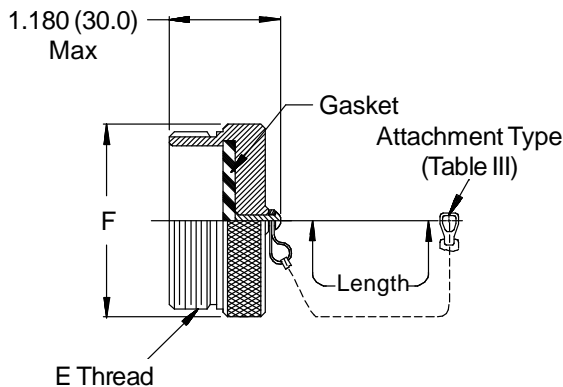
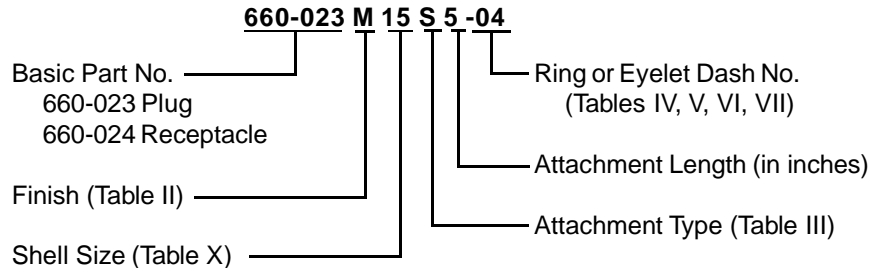
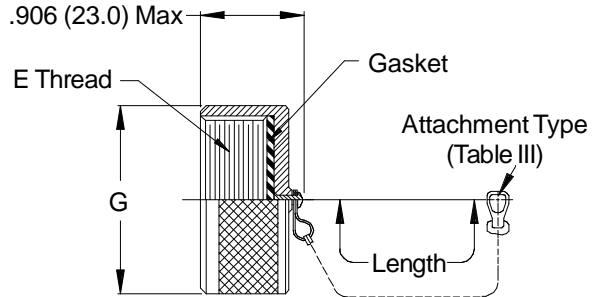

MIL-C-38999
Series III

660-023 Plug Cover

660-024 Receptacle Cover
TABLE X: SHELL SIZE DIMENSIONS

Shell Size	Shell Size Code Ref.	E Thread	F Max	G Max
09	A	.6250-0.1P-0.3L-TS	.906 (23.0)	.906 (23.0)
11	B	.7500-0.1P-0.3L-TS	1.024 (26.0)	1.102 (28.0)
13	C	.8750-0.1P-0.3L-TS	1.220 (31.0)	1.220 (31.0)
15	D	1.0000-0.1P-0.3L-TS	1.300 (33.0)	1.260 (32.0)
17	E	1.1875-0.1P-0.3L-TS	1.457 (37.0)	1.457 (37.0)
19	F	1.2500-0.1P-0.3L-TS	1.575 (40.0)	1.535 (39.0)
21	G	1.3750-0.1P-0.3L-TS	1.732 (44.0)	1.654 (42.0)
23	H	1.5000-0.1P-0.3L-TS	1.811 (46.0)	1.772 (45.0)
25	J	1.6250-0.1P-0.3L-TS	1.969 (50.0)	1.929 (49.0)

See inside back cover fold-out or page 14 for Table II.

Metric dimensions (mm) are indicated in parentheses.

660-023 (Plug) - 660-024 (Receptacle)
Protective Covers
MIL-C-38999 Series III Threaded



66 & 78

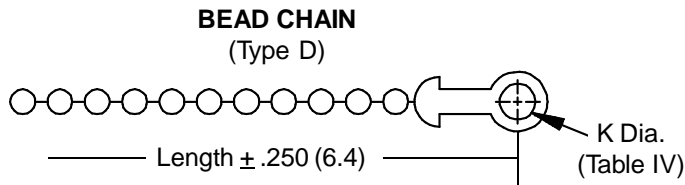
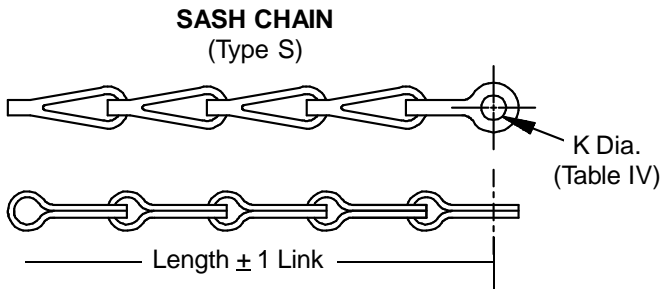
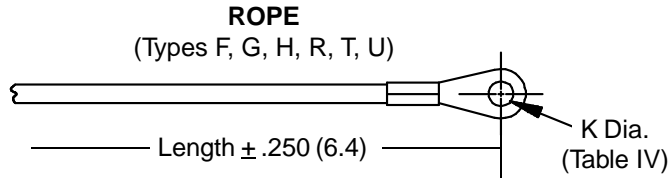

TABLE III: ATTACHMENT

Sym	Attachment Type
D	Bead Chain, Cres., Passivate
F	Wire Rope, Nylon Jacket
G	Nylon Rope
H	Wire Rope, Teflon Jacket
N	No Attachment
R	Wire Rope, PVC Jacket
S	#8 Sash Chain, Cres., Passivate
T	Wire Rope, No Jacket
U	Wire Rope, Polyurethane Jacket with Terminal

TABLE IV: EYELET

Dash No.	K DIA ±.010 (0.3)
01	.140 (3.6)
02	.182 (4.6)
03	.191 (4.9)
04	.197 (5.0)
05	.167 (4.2)
06	.125 (3.2)
07	.218 (5.5)
09	.156 (4.0)
00	No Eyelet

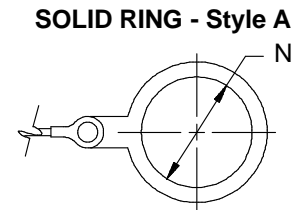
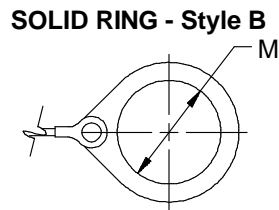
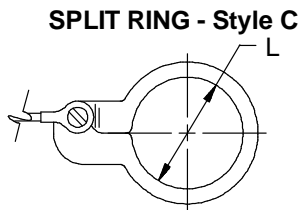

TABLE V: SPLIT RING STYLE C

Dash No.	L Dia. ±.015 (0.4)	Dash No.	L Dia. ±.015 (0.4)
50	.425 (10.8)	74	1.625 (41.3)
52	.485 (12.3)	76	1.750 (44.5)
54	.640 (16.3)	78	1.875 (47.6)
56	.750 (19.1)	80	1.980 (50.3)
58	.890 (22.6)	82	2.060 (52.3)
60	1.015 (25.8)	84	2.235 (56.8)
62	1.095 (27.8)	86	2.310 (58.7)
64	1.130 (28.7)	88	2.475 (62.9)
66	1.250 (31.8)	90	2.655 (67.4)
68	1.350 (34.3)	92	2.810 (71.4)
70	1.390 (35.3)	94	3.045 (77.3)
72	1.485 (37.7)		

TABLE VI: SOLID RING STYLE B

Dash No.	M Dia. ±.015 (0.4)	Dash No.	M Dia. ±.015 (0.4)
08	.468 (11.9)	24	1.484 (37.7)
10	.593 (15.1)	25	1.577 (40.1)
12	.718 (18.2)	27	1.640 (41.7)
13	.765 (19.4)	28	1.687 (42.8)
14	.844 (21.4)	29	1.765 (44.8)
15	.890 (22.6)	30	1.890 (48.0)
16	.968 (24.6)	31	1.953 (49.6)
17	1.015 (25.8)	32	1.968 (50.0)
18	1.093 (27.8)	33	2.077 (52.8)
19	1.140 (29.0)	35	2.140 (54.4)
20	1.203 (30.6)	36	2.187 (55.5)
21	1.265 (32.1)	40	2.406 (61.1)
22	1.343 (34.1)	44	2.656 (67.5)
23	1.453 (36.9)	48	3.031 (77.0)
		118	.310 (7.9)

TABLE VII: SOLID RING STYLE A

Dash No.	N Dia. ±.015 (0.4)	Dash No.	N Dia. ±.015 (0.4)
095	.312 (7.9)	109	1.266 (32.2)
100	.391 (9.9)	209	1.312 (33.3)
101	.516 (13.1)	110	1.391 (35.3)
102	.583 (14.8)	210	1.438 (36.5)
103	.641 (16.3)	111	1.521 (38.6)
104	.708 (18.0)	211	1.536 (39.0)
105	.766 (19.5)	112	1.641 (41.7)
205	.788 (20.0)	113	1.766 (44.9)
106	.896 (22.2)	213	1.812 (46.0)
206	.907 (23.0)	114	1.891 (48.0)
107	1.016 (25.8)	214	1.938 (49.2)
207	1.025 (26.0)	115	2.078 (52.8)
108	1.141 (29.0)	116	2.406 (61.1)
308	1.188 (30.2)	117	2.510 (63.8)
208	1.203 (30.6)		



Part Number: 660-024NF11R4-106

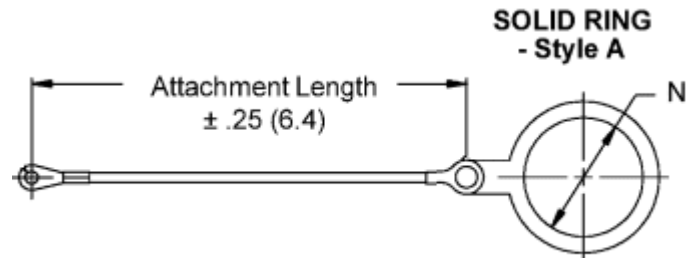
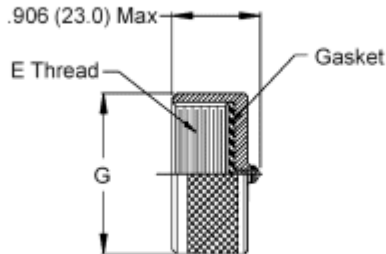

Product Series = 660
 Basic Part Number = 024
 Shell Size = 11
 Finish Code = NF
 (Cadmium Plate, Olive Drab Over, Electroless
 Nickel; M85049 Symbol Reference: W;
Specification: 1000 Hour Corrosion Resistance)
 Length Code = 4 (4 inches)
 Dash Number = 106
 Ring Type = Solid Ring (Style A)
 Attachment Type = Wire Rope, PVC Jacket
 Shell Size (Reference) = B

Shell Size (Reference) = B
 E Thread Class 2A/2B = .7500-0.1P-0.3L-TS
 G Dimension Max = 1.102 (28.0)
 N Diameter = .896 (22.2) ± .015 (.4)
 Dimensions are in Inches (Millimeter)

NOTES:

Unless otherwise specified, the following dimensional tolerances will apply:
 .xx = ± .03 (0.8); .xxx = ± .015 (0.4); Lengths = ± .060 (1.52); Angles = ± 5°

[Open Catalog Page](#)
[Quote](#)
[Print](#)
[Close](#)

[HOME](#)
[SAME-DAY](#)
[RFQ](#)
[SALES](#)
[QUIKCONNECT](#)
[FEEDBACK](#)

MIL-C-38999 Series III

660-023 M 15 S 5 -04
 Basic Part No. _____
 660-023 Plug
 660-024 Receptacle
 Finish (Table II) _____
 Shell Size (Table X) _____
 Ring or Eyelet Dash No.
 (Tables IV, V, VI, VII)
 Attachment Length (in inches)
 Attachment Type (Table III)

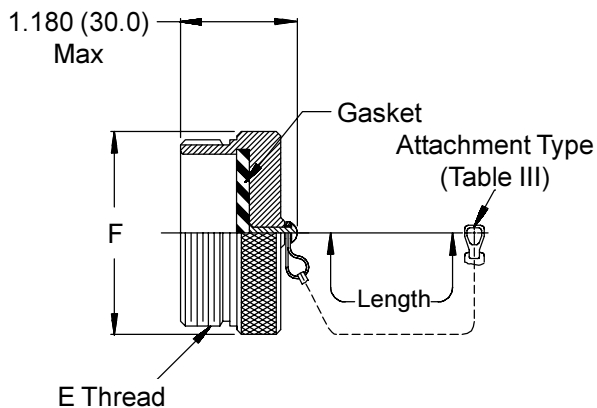

660-023 Plug Cover

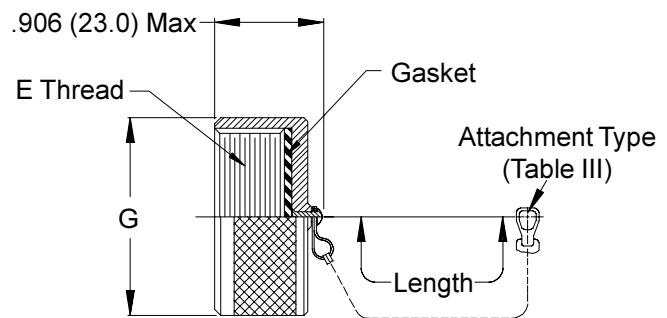

660-024 Receptacle Cover

TABLE X

Shell Size	Shell Size Code Ref.	E Thread	F Max	G Max
09	A	.6250-0.1P-0.3L-TS	.906 (23.0)	.906 (23.0)
11	B	.7500-0.1P-0.3L-TS	1.024 (26.0)	1.102 (28.0)
13	C	.8750-0.1P-0.3L-TS	1.220 (31.0)	1.220 (31.0)
15	D	1.0000-0.1P-0.3L-TS	1.300 (33.0)	1.260 (32.0)
17	E	1.1875-0.1P-0.3L-TS	1.457 (37.0)	1.457 (37.0)
19	F	1.2500-0.1P-0.3L-TS	1.575 (40.0)	1.535 (39.0)
21	G	1.3750-0.1P-0.3L-TS	1.732 (44.0)	1.654 (42.0)
23	H	1.5000-0.1P-0.3L-TS	1.811 (46.0)	1.772 (45.0)
25	J	1.6250-0.1P-0.3L-TS	1.969 (50.0)	1.929 (49.0)

See inside back cover fold-out or page 14 for Table II.

Metric dimensions (mm) are indicated in parentheses.

Series 66 Protective Covers



ROPE (Types F, G, H, R, T, U)

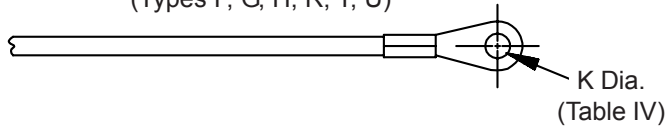

SASH CHAIN (Type S)

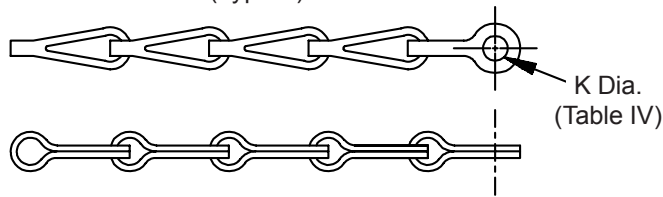

BEAD CHAIN (Type D)

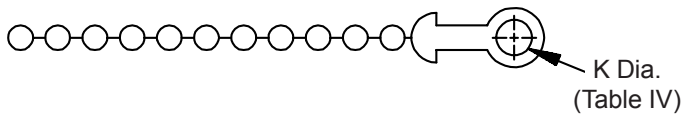

Sym	Attachment Type
D	Bead Chain, Cres., Passivate
F	Wire Rope, Nylon Jacket
G	Nylon Rope
H	Wire Rope, Teflon Jacket
N	No Attachment
R	Wire Rope, PVC Jacket
S	#8 Sash Chain, Cres., Passivate
T	Wire Rope, No Jacket
U	Wire Rope, Polyurethane Jacket with Terminal

Dash No.	K DIA
01	.140 (3.6)
02	.182 (4.6)
03	.191 (4.9)
04	.197 (5.0)
05	.167 (4.2)
06	.125 (3.2)
07	.218 (5.5)
09	.156 (4.0)
00	No Eyelet

SPLIT RING - Style C

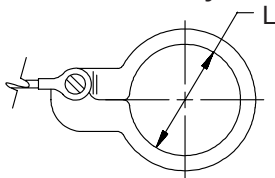

SOLID RING - Style B

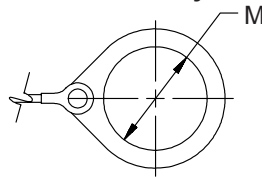

SOLID RING - Style A

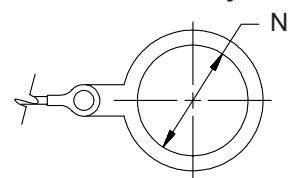

Dash No.	L Dia. ±.015 (0.4)	Dash No.	L Dia. ±.015 (0.4)
50	.425 (10.8)	74	1.625 (41.3)
52	.485 (12.3)	76	1.750 (44.5)
54	.640 (16.3)	78	1.875 (47.6)
56	.750 (19.1)	80	1.980 (50.3)
58	.890 (22.6)	82	2.060 (52.3)
60	1.015 (25.8)	84	2.235 (56.8)
62	1.095 (27.8)	86	2.310 (58.7)
64	1.130 (28.7)	88	2.475 (62.9)
66	1.250 (31.8)	90	2.655 (67.4)
68	1.350 (34.3)	92	2.810 (71.4)
70	1.390 (35.3)	94	3.045 (77.3)
72	1.485 (37.7)		

Dash No.	M Dia. ±.015 (0.4)	Dash No.	M Dia. ±.015 (0.4)
08	.468 (11.9)	24	1.484 (37.7)
10	.593 (15.1)	25	1.577 (40.1)
12	.718 (18.2)	27	1.640 (41.7)
13	.765 (19.4)	28	1.687 (42.8)
14	.844 (21.4)	29	1.765 (44.8)
15	.890 (22.6)	30	1.890 (48.0)
16	.968 (24.6)	31	1.953 (49.6)
17	1.015 (25.8)	32	1.968 (50.0)
18	1.093 (27.8)	33	2.077 (52.8)
19	1.140 (29.0)	35	2.140 (54.4)
20	1.203 (30.6)	36	2.187 (55.5)
21	1.265 (32.1)	40	2.406 (61.1)
22	1.343 (34.1)	44	2.656 (67.5)
23	1.453 (36.9)	48	3.031 (77.0)
		118	.310 (7.9)

Dash No.	N Dia. ±.015 (0.4)	Dash No.	N Dia. ±.015 (0.4)
095	.312 (7.9)	109	1.266 (32.2)
100	.391 (9.9)	209	1.312 (33.3)
101	.516 (13.1)	110	1.391 (35.3)
102	.583 (14.8)	210	1.438 (36.5)
103	.641 (16.3)	111	1.521 (38.6)
104	.708 (18.0)	211	1.536 (39.0)
105	.766 (19.5)	112	1.641 (41.7)
205	.788 (20.0)	113	1.766 (44.9)
106	.896 (22.2)	213	1.812 (46.0)
206	.907 (23.0)	114	1.891 (48.0)
107	1.016 (25.8)	214	1.938 (49.2)
207	1.025 (26.0)	115	2.078 (52.8)
108	1.141 (29.0)	116	2.406 (61.1)
308	1.188 (30.2)	117	2.510 (63.8)
208	1.203 (30.6)		



Reference Information Standard Materials and Finishes

TABLE II - STANDARD FINISHES

GLENAIR SYMBOL	M85049 SYMBOL REFERENCE ONLY	FINISH	SPECIFICATION(S)
A		Cadmium Plate, Bright	AMS-QQ-P-416, Type I, Class 2
B		Cadmium Plate, Olive Drab	AMS-QQ-P-416, Type II, Class 3
C*	A	Anodize, Black	AMS-A-8625, Type II, Class 2
G*		Hard Coat, Anodic	AMS-A-8625, Type III, Class 1
J		Iridite, Gold Over Cadmium Plate Over Electroless Nickel	MIL-C-5541, Class 3 AMS-QQ-P-416, Type II, Class 3 over AMS-C-26074, Class 4, Grade B
LF		Cadmium Plate, Bright Over Electroless Nickel	1000 Hour Corrosion Resistance
M	N	Electroless Nickel	AMS-C-26074, Class 4, Grade B
N		Cadmium Plate, Olive Drab Over Electroless Nickel	AMS-QQ-P-416, Type II, Class 3 over Electroless Nickel AMS-C-26074
NC		Zinc Cobalt, Dark Olive Drab	96 Hour Corrosion Resistance
NF	W	Cadmium Plate, Olive Drab Over Electroless Nickel	1000 Hour Corrosion Resistance
T		Cadmium Plate, Olive Drab Over Electroless Nickel	AMS-QQ-P-416, Type II, Class 3 over Electroless Nickel, AMS-C-26074, Class 4, Grade B
U**		Cadmium Plate, Black	AMS-QQ-P-416, Type II, Class 3
ZN		Zinc-Nickel Alloy, Olive Drab	ASTMB 841-91, Over Electroless Nickel 1000 Hour Salt Spray

* Anodize finish; not suitable for EMI Shielding or grounding applications.
 ** Applicable to corrosion resisting steel backshells and accessories. Consult factory for other available finishes.

The following standard materials are used for the majority of Glenair backshells and connector accessories. However, backshell components are not limited to those items listed, but are representative of

the elements used in Glenair's general accessory products. Contact Glenair for applicable specifications on items not listed below.

STANDARD MATERIALS - BACKSHELLS AND ACCESSORIES

COMPONENT	MATERIAL	SPECIFICATION
Machined components: such as backshell bodies, fabricated elbows, protective covers, rotatable couplers, dummy stowage receptacles, lock nuts, G-spring support rings, EMI ground rings, grommet followers, etc.	Aluminum	AMS-QQ-A-200, 225 ASTMB211, 221, 209
Die cast components: such as angular backshells, strain relief backshells, strain relief bodies, strain relief saddles, special EMI ground rings, etc.	Aluminum	QQ-A-591 ASTMB85, 26
Backshells or strain reliefs: available in optional corrosion resisting steel; and hardware: such as screws, washers, rivets, wire rope, sash chain, band straps, etc.	Corrosion Resisting Steel	ASTMA582 (300 Series) AMS-QQ-S-763
Elastomeric seals: such as O-rings, cable jacket seals, grommets, etc.	Silicone	ZZ-R-765, MIL-R-25988
Anti-friction and thrust washers	Teflon	TFE
Anti-rotation device	Corrosion Resistant Material	N/A

BODY STRAP

Glenair offers an optional stainless steel body strap for attaching protective covers as illustrated. To specify body strap, add suffix letter C to the end of the part number. For example 360AS001M1610M6C.

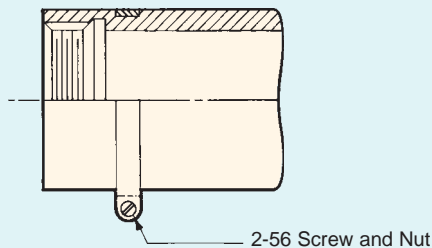

NOTES

On all length callouts, tolerance is $\pm .060$ unless otherwise specified.

Unless otherwise specified, the following other dimensional tolerances will apply:

- .xx = $\pm .03$ (0.8)
- .xxx = $\pm .015$ (0.4)
- Lengths = $\pm .060$ (1.52)
- Angles = $\pm 5^\circ$

Metric dimensions (mm) are indicated in parentheses

NOTE: For your convenience these tables have been reproduced inside the back cover fold-out.



Part Number Cross Ref Description Products More

Q 660-02 Part Number

gdcsearch | [Logout](#) | [Help](#)
[Advanced Search](#)

- [Home](#)
- [Products](#)
- [Suppliers](#)
- [Parametric Search](#)
- [BOM Manager](#)
- [Military](#)
- [PCN Search](#)
- [Compare](#)
- [My Briefcase](#)
- [Customize this page](#)

Part Search ▶ 660-02 ▶ Part Details

[Submit Support Ticket](#)

660-02 - Glenair

Lifecycle - Active

Last Check Date - Apr 07, 2011



[Add To My Briefcase](#) | [Export to XML](#) | [Back To Results](#)

[Add a comment](#) | [Add an attachment](#)

- Summary
- Parametric
- Manufacturing
- Environmental NEW!
- Risk Analysis
- Documents
- Supplier Profile
- History
- Comments BETA

Risk Analysis [Download Risk Report](#)



Lifecycle Risk	Low
Part Status	Active
Part Lifecycle Stage	Mature
Estimated Years to EOL	7.5 Years
Estimated EOL Date	2019

MultiSourcing Risk	Medium
Crosses available within Part Category	NO
Other Sources	0 Source

Inventory Risk	Medium
Market Availability	1 Distributor(s) more dates

RoHS Risk	Medium
RoHS Compliant	No

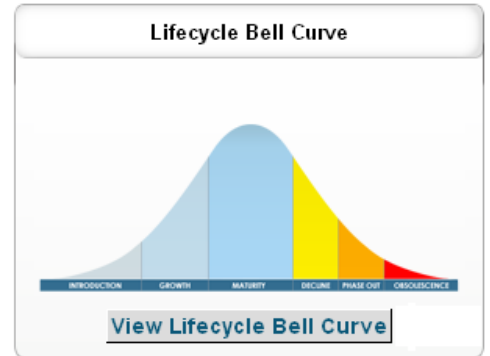

Risk Analysis

For further information on the analysis of the SiliconExpert Risk Analysis & Obsolescence Forecast Algorithm developed in collaboration with the University of Maryland's CALCE, please click [here](#).

Supplier Obsolescence Profile

PDNs issued for obsolescence notices	NO
PDNs made public	NO
Obsolescence data listed on website	NO
Date of obsolescence listed on website	NO
Obsolescence data extractable from PDFs	NO

Qwik Connect

G L E N A I R ■ J A N U A R Y 2 0 0 9 ■ V O L U M E 1 3 ■ N U M B E R 1

The Long Goodbye

Is it Time to Bid Cadmium Adieu?

On the Hunt for a Cadmium Replacement

Cadmium, a chemical element with the symbol Cd and atomic number 48, is a silver-white metal with a melting temperature of 321°C. When heated above this temperature, for example in an accidental fire, cadmium oxide fumes may be emitted. These fumes are considered to be dangerous to the environment and human health; which is why Glenair component parts plated with cadmium are specifically rated to only 175°C.

While cadmium oxide exposure risks in humans are still relatively unknown, it has nevertheless become a goal of many industries to proactively eliminate cadmium from manufactured products and systems. This movement is a significant challenge in our industry, particularly since military specifications still require the use of cadmium. In fact, military parts are currently exempt from cadmium and other substance reduction initiatives.

Because of its desirable functional qualities, electroplated cadmium has long been applied to components on commercial and military land, sea and air systems as well as NASA space systems. Cadmium provides up to 1,000 hours of sacrificial corrosion protection and excellent lubricity and resistance to galling for threaded applications. While the reduction and eventual elimination of cadmium from military systems is a laudable goal, replacement materials must deliver the same levels of performance.

The Department of Defense and the National Aeronautics and Space Administration (NASA) recently formed the Joint Cadmium Alternatives Team (JCAT) to identify and validate alternatives to cadmium for DoD systems and NASA applications. Working with a variety of DoD organizations and OEMs, JCAT defined the functional properties of electroplated cadmium, the substrates and components to which it is currently applied, and the desired properties for potential alternative/replacement materials.

Along with these military and space pollution prevention initiatives, a number of governmental controls have emerged recently. In the United States, the EPA and several states have issued regulations restricting the use of certain heavy metals. The European Union introduced the sweeping Restrictions of Hazardous Substances (RoHS) directive. China has established its own version of RoHS.

The Joint Strike Fighter (JSF) program is the first major program to fall subject to JCAT's efforts and is planned to be cadmium free. Additionally, JSF program managers intend to eliminate the use of hexavalent chromium, another useful but reportedly toxic substance integral to a number of finish treatment options. On the commercial front, the Boeing 787 "Dreamliner," we are told, will be fabricated exclusively from cad-free materials.

So the hunt for a cadmium replacement is on, and in this issue of *QwikConnect* we'll bring you up to speed on all the latest developments.



Corrosion Protection Treatments

Fighting corrosion is a perennial struggle in electrical interconnect systems. Glenair has developed a broad range of technologies and techniques to win the battle in even the harshest application environments. Our objective is always to build parts which meet industry standards and provide years of service. Corrosion-proof composite thermoplastic solutions, stainless steel technologies, and durable finish platings are at the forefront of our efforts to solve corrosion problems before they can affect the safe operation of high-reliability interconnect systems.

Plating is the protective coating of potentially corrosive materials, or combinations of materials, with electro- and electroless-deposited metals and other substances. As long as the protective coating is unbroken, corrosion is held at bay. In real world applications, though, parts get nicked, scratched and worn with use. The best platings, therefore, are “sacrificial,” meaning they halt corrosion by giving up their metals to interfere with the ionic current flow that would otherwise rust the part needing protection.

Electroplating

Electro-depositing, or “electroplating,” is the coating of an object with a thin layer of metal, or a synthetic substance such as PTFE, using electricity. The metals most often used are gold, silver, chromium, copper, nickel, tin, cadmium, and zinc. The object to be plated, called the “work,” is usually a different metal, but can be the same metal or even a nonmetal, such as a composite thermoplastic.

Electroplating usually takes place in a tank of solution containing the metal to be deposited on the work. When these electroplating chemicals dissolve, the atoms move freely, but lose one or more negatively-charged electrons and, as a result, become positively charged ions. Although ions are not visible to the naked



eye, the solution may show some color; a nickel solution, for example, is emerald green.

The object to be plated is negatively charged by an electrical source and attracts the positive metal ions, which coat the object, regain their lost electrons and become metal once again.

Another process called electroless-deposited plating operates without using electricity. The action is purely chemical and, once started, is autocatalytic (that is, it runs by itself). Electroless plating enables metal coating of other metals and nonconductive materials, such as plastics, glasses and ceramics.

Many effective protective coatings used in the interconnect industry use a combination of two or more finish materials in order to create a physical barrier between joining parts and to prevent galvanic corrosion due to dissimilar metals. The approved U.S. Navy finish, cadmium over electroless nickel is the most

common finish of this type provided by Glenair. Other choices include cromate over cadmium, zinc-cobalt, and zinc-nickel.

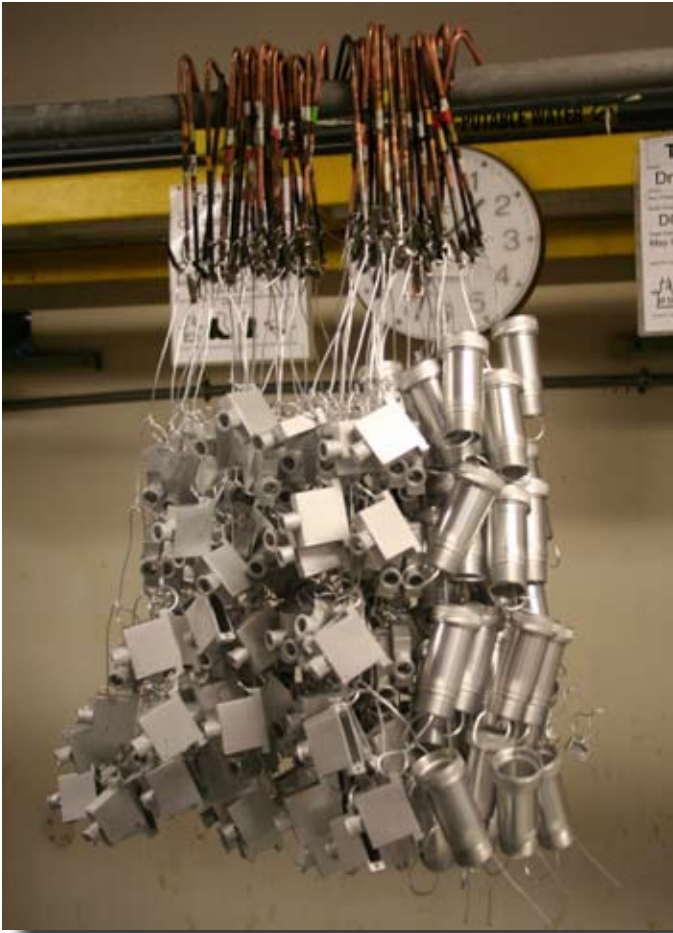

Component parts must be individually wired in order to form the electrical circuit required in the electroplating process. When current is passed through the electrolyte rich plating solution, the parts become the cathode and the sacrificial plating material becomes the anode in the galvanic process.

Passivation

Stainless steel parts require a special finish treatment known as “passivation.” The chromium content of stainless steel causes the natural formation of an invisible, corrosion-resisting chromium oxide film on the steel surface. If damaged mechanically or chemically, this film is self healing as long as oxygen is present. The protective quality of this oxide film layer can be enhanced by passivation.

According to ASTM A380, passivation is "the removal of exogenous iron or iron compounds from the surface of stainless steel by means of a chemical dissolution, most typically by a treatment with an acid solution that will remove the surface contamination, but will not significantly affect the stainless steel itself." The ASTM spec goes on to describe passivation as "the chemical treatment of stainless steel with a mild oxidant, such as a nitric acid solution, for the purpose of enhancing the spontaneous formation of the protective passive film." Passivation removes "free iron" contamination left behind on the surface of the stainless steel from casting, machining and other secondary operations. These contaminants are potential corrosion sites if not removed.



Passivation, combined with a high quality grade of stainless steel, can create products which are extremely corrosion-resistant and will provide many years of service.

Anodization

Anodizing is an electrolytic process that places aluminum oxide films on aluminum. The resulting coating is uniform, much harder, and denser than natural oxidation. It is formed by converting the surface of the part with a simultaneous penetration and build-up of aluminum oxide. Unlike paint, which can flake off if not applied properly, anodized finishes are actually formed from the base material and cannot flake off. The aluminum oxide finish is

very hard and exceptionally wear resistant. The aluminum can also be dyed at the end of the anodizing process for a colored finish. Anodized parts have a non-conductive finish.



Electrodeposited Paint or Electroplating

Electrodeposited paint, also referred to as electrocoating, electrophoretic deposition, or electropainting, is an organic finishing



Glenair's electrodeposited paint line is used primarily for commercial grade components, such as our MIL-DTL-5015 (ITS) and MIL-DTL 26482 (IPT-SE) type connector series.

process that uniformly applies thin-film primers and one-coat finishes to metallic substrates. Electrodeposited paint resembles electroplating by using electric current to deposit a coating onto substrates. However, electrocoating deposits waterborne paint onto substrates rather than metal ions.

Because of the uniformity of the applied coating, and excellent adhesion properties, corrosion protection offered by electrodeposited paint is quite high on both steel and aluminum substrates. Corrosion testing performed by the National Defense Center for Environmental Excellence (NDCEE) has demonstrated exceptional performance when used as a primer in combination with both aerospace and chemical agent resistant coating (CARC) topcoats. Electrodeposited paint also offers reduced environmental impact associated with hazardous solvents, and solid/hazardous waste generation and disposal. However, electrodeposited paint is limited to one-coat application and penetration of electrocoat material to the interior surfaces of a tubular shaped item may not be feasible.



Glenair offers its Black Electrodeposited Paint finish treatment on Signal and Power Connection Products such as the ITS connector series, based on MIL-DTL-5015 with reverse bayonet and threaded coupling options, and the IPT-SE connector series based on MIL-C-26482. Electrodeposited Paint can also be specified for other Glenair products.

Environmental Health and the Mil-Specs

MIL-DTL-38999L, published in May 2008, and MIL-DTL-83513, published in October 2008, call for new plating options for connectors and accessories. These are among the most important mil-specs controlling circular and rectangular military interconnects. Additionally, MIL-DTL-28840, the controlling mil-spec for shipboard, high density circular interconnects, is in the revision process. All three of these new or prospective mil-specs call out new plating options listed below.

It is expected that when other military and related industry specs are revised, they will also adopt these changes. For instance, the “grand-daddy” of specifications for backshells and accessories, AS85049, controlled by the Society of Automotive Engineers (SAE), will likely incorporate the plating additions established by these revised mil-specs.

Code P: Pure electrodeposited aluminum, conductive, temperature rated -65°C to 175°C, in accordance with MIL-DTL-83488, Type II, to withstand 500 hours of dynamic salt spray testing. (Glenair offers AlumiPlate electrodeposited aluminum plating that matches these requirements).

Code T: Nickel fluorocarbon polymer over a suitable underplate, conductive, temperature rated -65°C to 175°C, to withstand 500 hours of dynamic salt spray testing. (Glenair offers 1000 Hour Grey Nickel-PTFE plating that matches these requirements).

Code Z: Zinc nickel in accordance with ASTM B841 over a suitable underplate, conductive, temperature rated -65°C to 175°C, to withstand 500 hours of dynamic salt spray testing. Color shall be matte olive drab. (Glenair offers zinc-nickel plating that matches these requirements).

Galvanic Corrosion and the Case for Composites

Anyone who has worked on a rusty old automobile knows the dissimilar metals effect. The mix of aluminum and cast iron components in older cars led to some truly monstrous corrosion problems due to “galvanic” corrosion—the electrochemical action of two dissimilar metals in the presence of an electrolyte and an electron conductive path. When two different metals are in physical contact in the presence of an acid or salt galvanic corrosion will occur.

Galvanic action is a principal corrosion problem in electrical interconnect systems. Specifically, the galvanic corrosion between the base metal of a part and its conductive plating. One way to solve this corrosion challenge is to specify composite thermoplastics for connectors and backshells. Composite thermoplastics offer unlimited corrosion resistance. Conversely, aluminum interconnect components are immediately subject to galvanic coupling causing the metal material to be sacrificed to its cadmium/nickel plating. Substituting composite plastic for the aluminum eliminates conditions required for this type of corrosion to occur.

Glenair has a responsibility to deliver interconnect systems and hardware without “built-in” corrosion problems. To prevent corrosion problems in backshells, for example, engineers use their thorough understanding of design and materials science to produce conductive, plated products which both prevent EMI and resist corrosion in harsh application environments, and the simplest solution to this challenge by far is the specification of composite materials in place of metal.



Plating for Conductivity

In our electrical interconnect industry, the problems associated with corrosion are compounded by the need to produce parts that are electrically conductive. As we all know, it is the conductive properties of plated connectors and backshells which prevent electromagnetic interference (EMI) from disrupting the flow of data throughout the interconnect system. To prevent EMI from permeating into the system, conductive cable shielding is grounded to plated connectors and accessories to take the unwelcome EMI harmlessly to ground. If metal connectors and accessories could be produced without the need for conductive surface platings, corrosion in interconnect systems would be a much easier problem to resolve. Surface platings themselves significantly compound the difficulty of preventing interconnect system corrosion.

All matter is electrical by nature. Everything—from your body’s nervous system to the earth itself—has electrical properties. All matter is made up of atoms which in turn are composed of protons, neutrons, and electrons. The center, or nucleus of the atom, is composed of positively charged protons and neutral neutrons. The process of corrosion takes place at this most basic molecular level. To be a bit more exact, the corrosion process is electrochemical in nature; for the process to occur several specific conditions must be met, and not all are solely electrical:

- There must be a positive or anodic area, referred to as the “anode.”
- There must be a negative or cathodic area, referred to as the “cathode.”
- There must be a path for ionic current flow, referred to as the “electrolyte.”
- There must be a path for electronic current flow, which is normally a “metallic path.”

The electrical pressure between the two magnetic poles—the anode and the cathode—results in a migration of electrons from one to the other along the metallic path. With the loss of electrons, positively-charged atoms remain at the anode, combining with negatively-charged ions in the environment to form, in the case of steel parts, ferrous hydroxide, or rust. In most interconnect applications the role of the ionic current flow is played by the atmosphere, rain or salt spray on ships. The rate at which metal is removed by the corrosive process is usually measured in amperes or thousandths of ampere (milliamperes). In interconnect applications the conductor for this electrical current can be the mating point of the various subcomponents—such as fasteners, bands and braids—or the threaded interface between the backshell and connector. But the metallic path for the current flow can also be between the shell of the component and its own metallic surface plating.

The corrosion process described above will continue without rest, until one or more of the four conditions is no longer met. For this reason, the elimination of one of the four conditions is the very heart and soul of corrosion prevention efforts. An unbroken (perfect) protective coating on the surface of a metal part will, for example, prevent the electrolyte from connecting the cathode and anode and so eliminate the ionic current flow. Sacrificial anodes, to cite another example, can halt corrosion by integrating an alternative metal material into the metallic path (usually zinc) to halt corrosion of the more valuable, protected equipment. Perhaps the ultimate solution to corrosion is to replace the metallic materials with engineering plastics, essentially eliminating the anode from the equation altogether. Dissimilar metals are the most frequent cause of unexpected corrosion failures in marine environments, which is why Glenair’s composite components are of such value in systems subject to salt spray, stack gas and other corrosive electrolytes.

Glenair Material and Finish Options

This chart presents a selection of the broad range of base materials and plating options available from Glenair. Innovation and qualification of material and finish types is a major Glenair strength.

Code	Material	Finish	Finish Specification	Hrs. Salt Spray	Electrical Conductivity	Operating Temp. Range	RoHS	Notes
A	Aluminum	Cadmium, No Chromate	SAE-AMS-QQ-P-416 Type I Class 3	48	Conductive	-65 to +175°C		Not recommended for new projects. LF is preferred.
AB	Marine Bronze	Unplated		1000	Conductive	-65 to +200°C	✓	Marine and geophysical applications.
AL	Aluminum	AlumiPlate, Clear Chromate	MIL-DTL-83488, Class 2, Type II over electroless nickel	1000	Conductive	-65 to +175°C	✓	Approved for MIL-DTL-38999L and MIL-DTL-83513G.
B	Aluminum	Cadmium, Olive Drab	SAE-AMS-QQ-P-416 Type II Class 3	96	Conductive	-65 to +175°C		Not recommended for new projects. NF is preferred.
C	Aluminum	Anodize, Black	AMS-A-8625 Type II Class 2	336	Non-Conductive	-65 to +175°C	✓	Glenair's standard black anodize finish.
E	Aluminum	Chem Film	MIL-DTL-5541 Type 1 Class 3	168	Conductive	-65 to +175°C		Glenair's standard chem film finish.
G	Aluminum	Anodize, Hardcoat	AMS-A-8625 Type III, Class 1, .001" thick	336	Non-Conductive	-65 to +200°C	✓	Not recommended for new projects. G2 is preferred.
G2	Aluminum	Anodize, Hardcoat	AMS-A-8625, Type III, Class 1, .002" thick	336	Non-Conductive	-65 to +200°C	✓	Dark olive grey color. Glenair's preferred hardcoat finish.
J	Aluminum	Cadmium, Gold	SAE-AMS-QQ-P-416 Type II, Class 2 over electroless nickel	500	Conductive	-65 to +175°C		Not recommended for new projects. JF is preferred.
JF	Aluminum	Cadmium, Gold	SAE-AMS-QQ-P-416 Type II, Class 2 over electroless nickel	1000	Conductive	-65 to +175°C		Glenair's preferred gold cadmium finish.
LF	Aluminum	Cadmium, Clear	SAE-AMS-QQ-P-416 Type II Class 2 over electroless nickel	1000	Conductive	-65 to +175°C		Glenair's preferred clear cadmium finish.
M	Aluminum	Electroless Nickel	AMS-C-26074 Class 4 Grade B; ASTM-B-733, SC 2, Type IV	48	Conductive	-65 to +200°C	✓	Glenair's standard electroless nickel finish.
MT	Aluminum	Nickel-PTFE	GMF-002 Type II Class 1	1000	Conductive	-65 to +175°C	✓	Approved for MIL-DTL-38999L and MIL-DTL-83513G.
N	Aluminum	Cadmium, Olive Drab	SAE-AMS-QQ-P-416 Type II Class 3 over electroless nickel	500	Conductive	-65 to +175°C		Not recommended for new projects. NF is preferred.
NC	Aluminum	Zinc-Cobalt, Olive Drab	ASTM B 840 Grade 6 Type D over electroless nickel	350	Conductive	-65 to +175°C		Glenair's standard olive drab zinc-cobalt finish.
NF	Aluminum	Cadmium, Olive Drab	SAE-AMS-QQ-P-416 Type II Class 2 over electroless nickel	1000	Conductive	-65 to +175°C		Glenair's standard olive drab cadmium finish.
P	Stainless Steel	Electrodeposited Nickel	SAE-AMS-QQ-N-290 Class 1 Grade F	500	Conductive	-65 to +200°C	✓	Not recommended for new projects. ZM is preferred.
T	Aluminum	Cadmium, No Chromate	SAE-AMS-QQ-P-416 Type I Class 3	48	Conductive	-65 to +175°C		Not recommended for new projects. LF is preferred.
TP2	Titanium	Electrodeposited Nickel	SAE-AMS-QQ-N-290 Class 1 Grade F	96	Conductive	-65 to +200°C	✓	Glenair's preferred finish for titanium connectors.
U	Aluminum	Cadmium, Black	SAE-AMS-QQ-P-416 Type I Class 3	48	Conductive	-65 to +175°C		Not recommended for new projects. UF is preferred.
UC	Aluminum	Zinc-Cobalt, Black	ASTM B 840 Grade 6 Type D over electroless nickel	350	Conductive	-65 to +175°C		Glenair's standard black zinc-cobalt finish.
UCR	Aluminum	Zinc-Cobalt, Black	ASTM B 840 Grade 6 Type D over electroless nickel	350	Conductive	-65 to +175°C	✓	RoHS version of UC.
UF	Aluminum	Cadmium, Black	SAE-AMS-QQ-P-416 Type II Class 2 over electroless nickel	1000	Conductive	-65 to +175°C		Glenair's preferred black cadmium finish.
XAL	Composite	AlumiPlate	MIL-DTL-86448, Class 2, Type II over electroless nickel	2000	Conductive	-65 to +175°C	✓	Approved for MIL-DTL-38999L.
XB	Composite	Unplated Black		2000	Non-Conductive	-65 to +175°C	✓	Glenair's standard unplated composite.
XM	Composite	Electroless Nickel	AMS-C-26074	2000	Conductive	-65 to +175°C	✓	Glenair's standard electroless nickel finish over composite.
XMT	Composite	Nickel-PTFE	GMS-002 Class 2 Type II	2000	Conductive	-65 to +175°C	✓	Approved for MIL-DTL-38999L.
XO	Composite	Unplated Light Brown		2000	Non-Conductive	-65 to +175°C	✓	Not recommended for new projects. Use XB.
XW	Composite	Cadmium, Olive Drab	SAE-AMS-QQ-P-416 Type II Class 3 over electroless nickel	2000	Conductive	-65 to +175°C		Glenair's standard olive drab cadmium finish over composite.
XZN	Composite	Zinc-Nickel, Black	ASTM B841 Grade 5 over electroless nickel	2000	Conductive	-65 to +175°C		Glenair's standard black zinc-nickel finish over composite.
Z1	Stainless Steel	Passivate	SAE-AMS-SAE-AMS-QQ-P-35 Type VI	1000	Conductive	-65 to +200°C	✓	Glenair's standard passivated stainless steel.
Z2	Aluminum	Gold	MIL-DTL-45204 Class 1 over electroless nickel	48	Conductive	-65 to +200°C	✓	Glenair's standard gold plating for space programs.
ZC	Stainless Steel	Zinc-Cobalt, Black	ASTM-B840, Grade 6		Conductive	-65 to +175°C		Glenair's standard zinc-cobalt over stainless steel.
ZCR	Stainless Steel	Zinc-Cobalt, Black	ASTM-B840, Grade 6		Conductive	-65 to +175°C	✓	RoHS version of ZC.
ZL	Stainless Steel	Electrodeposited Nickel	SAE-AMS-QQ-N-290 Class 1 Grade F	1000	Conductive	-65 to +200°C	✓	Used on hermetic connectors. Use ZM for other applications.
ZM	Stainless Steel	Electroless Nickel	AMS-C-26074 Class 1 Grade A		Conductive	-65 to +200°C	✓	Glenair's preferred nickel-plated stainless steel.
ZMT	Stainless Steel	Nickel-PTFE	GMF-002 Type II Class 3	1000	Conductive	-65 to +175°C	✓	Glenair's new 1000 Hour Grey over stainless steel.
ZN	Aluminum	Zinc-Nickel, Olive Drab	ASTM B841 Grade 5 over electroless nickel	1000	Conductive	-65 to +175°C		Glenair's standard olive drab zinc-nickel finish.
ZNU	Aluminum	Zinc-Nickel, Black	ASTM B841 Grade 5 over electroless nickel	1000	Conductive	-65 to +175°C		Glenair's standard black zinc-nickel finish.
ZU	Stainless Steel	Cadmium, Black	SAE-AMS-QQ-P-416 Type II Class 3	1000	Conductive	-65 to +175°C		Glenair's standard black cadmium over stainless steel.
ZW	Stainless Steel	Cadmium, Olive Drab	SAE-AMS-QQ-P-416 Type II Class 2 over electroless nickel	2000	Conductive	-65 to +175°C		Glenair's standard olive drab cadmium over stainless steel.

Glenair Backshell Plating Code and Mil-Spec Connector Finish Code Cross-Reference

MIL-DTL-38999 Series I and II		Recommended Glenair Accessory Code
Finish Code	Material, Finish	
A	Aluminum, Cadmium Plated, Clear Chromate	LF
B	Aluminum, Cadmium Plated, Olive Drab	NF
C	Aluminum, Anodize, Hardcoat	G2
E	Stainless Steel, Passivated	Z1
F	Aluminum, Electroless Nickel Plated	M
N	Stainless Steel, Electrodeposited Nickel (Hermetic)	P
P	Aluminum, Pure Dense Aluminum (AlumiPlate SM)	AL
R	Aluminum, Electroless Nickel	M
T	Aluminum, Nickel-PTFE	MT
U	Aluminum, Cadmium Plated, Clear Chromate	LF
X	Aluminum, Cadmium Plated, Olive Drab	NF
Z	Aluminum, Zinc-Nickel, Olive Drab	ZN

MIL-DTL-38999 Series III and IV Class Code		Recommended Glenair Accessory Code
Finish Code	Material, Finish	
C	Aluminum, Anodize, Hardcoat	G2
F	Aluminum, Electroless Nickel	M
G	Aluminum, Electroless Nickel	M
H	Stainless Steel, Passivated	Z1
J	Composite, Cadmium Plated, Olive Drab	XW
K	Stainless Steel, Passivated	Z1
L	Stainless Steel, Electrodeposited Nickel	P
M	Composite, Electroless Nickel Plated	XM
P	Aluminum, Pure Dense Aluminum (AlumiPlate SM)	AL
R	Aluminum, Electroless Nickel	M
S	Stainless Steel, Electrodeposited Nickel	P
T	Aluminum, Nickel-PTFE	MT
W	Aluminum, Cadmium Plated, Olive Drab	NF
X	Aluminum, Cadmium Plated, Olive Drab	NF
Z	Aluminum, Zinc-Nickel, Olive Drab	ZN

MIL-DTL-83513		Recommended Glenair Accessory Code
Finish Code	Material, Finish	Code
A	Aluminum, Pure Dense Aluminum (AlumiPlate SM)	AL
C	Aluminum, Cadmium Plated, Gold Chromate	JF
K	Aluminum, Zinc-Nickel, Olive Drab	ZN
N	Electroless Nickel	M
P	Stainless Steel, Passivated	Z1
T	Aluminum, Nickel-PTFE	MT

MIL-DTL-5015		Recommended Glenair Accessory Code
Class Code	Material, Finish	Code
A, B, C, E, F, P, R, W	Aluminum, Cadmium Plated, Olive Drab	NF

MIL-DTL-26482		Recommended Glenair Accessory Code
Material, Finish	Code	
Series I	Aluminum, Cadmium Plated, Olive Drab	NF
Series 2 Class L	Electroless Nickel	M
Series 2 Class W	Aluminum, Cadmium Plated, Olive Drab	NF

AS85049		Recommended Glenair Accessory Code
Finish Code	Material, Finish	Code
A	Aluminum, Black Anodize	C
B	Stainless Steel, Cadmium Plated, Black	ZU
G	Aluminum, Electroless Nickel Plated (Space)	M
J	Composite, Cadmium Plated, Olive Drab	XW
L	Composite, Cadmium Plated, Olive Drab ⁽¹⁾	XX
M	Composite, Electroless Nickel Plated	XM
N	Aluminum, Electroless Nickel Plated	M
P	Aluminum, Cadmium Plated, Olive Drab ⁽¹⁾	NFP
W	Aluminum, Cadmium Plated, Olive Drab	NF
T	Composite, Unplated	XO

(1) Selective plated with polysulfide barrier

the PLATING GAME

from 



Object of the Game: Improve the performance of metal and composite parts with protective electroplating.

How to Play: Roll dice to begin. First player to market with all the best materials and finishes wins!

START: A technician formulates solutions for use in the electroplating "bath" by combining acids and aqueous metals to form an electrolytic liquid. These solutions contain free metal ions that will eventually be deposited onto the part via electrical current.



Dihydrogen monoxide exposure. Return to start.



STEP 3: Raw parts are wired for electrical conductivity, thoroughly cleaned with an alkaline cleanser and an acid bath, and then finished with a sodium hydroxide "etch" to create a clean, adhesive surface to which platings can be applied.

STEP 2: Pre-mixed batches of plating solution are augmented with balls of sacrificial metals (in this case copper—located in hanging baskets) to provide an abundant source of free metal ions that will eventually deposit onto the connectors' surface.



Pass MADCAP Inspection. Move ahead 3 spaces.

STEP 8: Plated parts receive a final rinsing in hot deionized water, after which they are dried and cured in an oven. Lastly, parts are sorted and inspectors ensure there are no flaws.



FINISH!

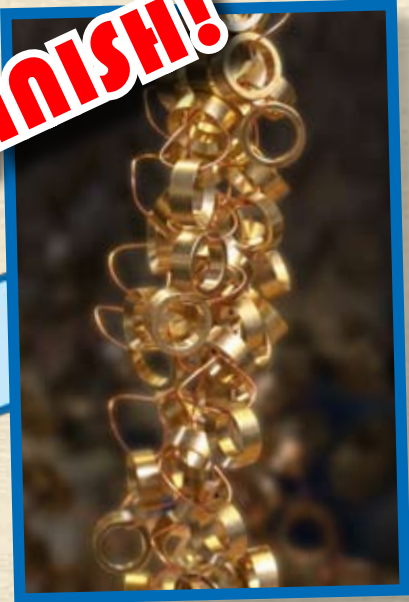

Delivery van trailer-hitch needs chrome job. Lose turn.

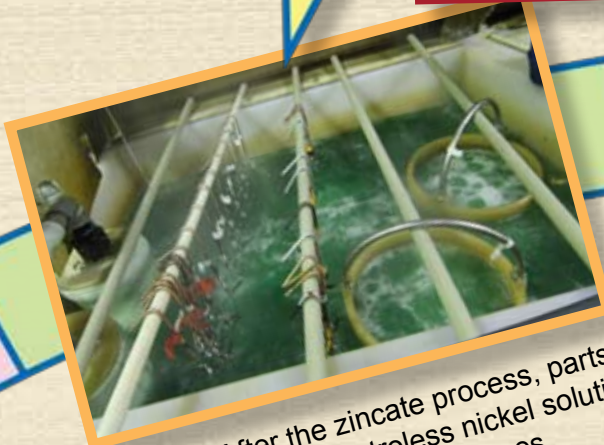

STEP 5: After the zincate process, parts are plated in an electroless nickel solution and rinsed thoroughly three times.

STEP 7: To attain specific colors, plated parts are submerged in an electroless chromic acid bath that has been dyed. The chromate solution reacts with the plating to yield colors such as olive drab, black and yellow.

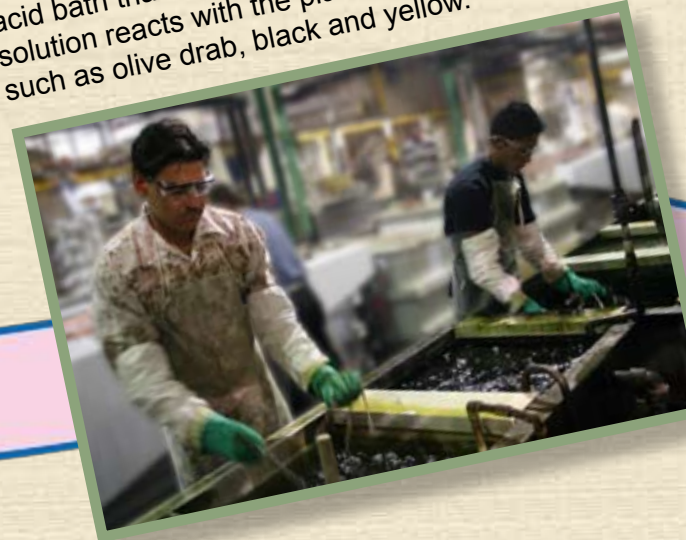

STEP 4: Clean parts are stripped of all oxide buildup in a nitric acid bath, then plated in an electroless zincate solution designed to protect the surface from further oxidation.

Finish rush job on schedule. Move ahead 2 spaces.

Waste a day plating Harley tail-pipes. Go back 7 spaces.

STEP 6: Parts are then immersed in an electrolytic bath of sulfuric acid and the metal plating material; and electricity is applied. The acid activates the surface of the parts, readying them to be plated. The submerged metal balls act as the anode (by giving up ions), and the parts as the cathode (by taking metal ions).



World Cup broadcast distracts workforce. Go back to Step 4.

Quick Picks: A Guide to Glenair's Most Popular Finishes



Electroless Nickel

Cost	\$	\$	\$	\$	\$
Conductivity	+	+	+	+	+
Corrosion Resistance	⌚	⌚	⌚	⌚	⌚

-65 to +200°C

Glenair Code **M**

RoHS Compliant Aluminum plated with electroless nickel offers excellent conductivity, wear resistance, and adequate corrosion resistance. Typically specified on electrical connectors and accessories used in avionics boxes, exoatmospheric equipment, and missiles, electroless nickel is a good choice when exposure to marine or corrosive atmospheres is not a primary concern. The plating process is purely chemical, and once started, is autocatalytic (it runs by itself).



Zinc-Nickel

Cost	\$	\$	\$	\$	\$
Conductivity	+	+	+	+	+
Corrosion Resistance	⌚	⌚	⌚	⌚	⌚

-65 to +175°C

Glenair Code **ZN, ZNU**

Not Compliant Recently added to MIL-DTL-38999 and MIL-DTL-83513, zinc-nickel plated aluminum has become a cost-effective alternative to cadmium. Available with olive drab or black chromate conversion coatings, zinc-nickel plated aluminum is commonly found on soldier systems and military airframe applications.



Black Zinc-Cobalt

Cost	\$	\$	\$	\$	\$
Conductivity	+	+	+	+	+
Corrosion Resistance	⌚	⌚	⌚	⌚	⌚

-65 to +175°C

Glenair Code **UCR, F7**

RoHS Compliant Zinc-cobalt with black trivalent chromate topcoat fills the need for a RoHS compliant conductive black finish for soldier systems, unmanned vehicles, robots and other tactical gear. This new addition to the Glenair lineup is likely to replace black zinc-nickel for new Future Combat System applications. Black zinc-cobalt plating is a standard finish on Glenair's ITS 5015 reverse bayonet power connectors.



Black Anodize

Cost	\$	\$	\$	\$	\$
Conductivity	+	+	+	+	+
Corrosion Resistance	⌚	⌚	⌚	⌚	⌚

-65 to +175°C

Glenair Code **C**

RoHS Compliant Black anodized aluminum is a popular finish for electrical connectors and accessories. Typically employed when conductivity is not required, black anodized aluminum offers a modicum of corrosion protection and is relatively inexpensive. Anodizing is an electrolytic process that creates aluminum oxide films by oxidizing the base metal. The resulting coating is much harder and denser than natural oxidation. The parts are immersed in a sulfuric acid solution at room temperature. After anodizing, the parts are dyed black.



Cadmium

Cost	\$	\$	\$	\$	\$
Conductivity	+	+	+	+	+
Corrosion Resistance	⌚	⌚	⌚	⌚	⌚

-65 to +175°C

Glenair Code **NF, LF, JF**

Not Compliant Cadmium plated aluminum has been the unchallenged workhorse of the defense/aerospace industry. Offering up to 1000 hours of salt spray protection when deposited over a preliminary coating of electroless nickel, cadmium is highly conductive, provides good lubricity and resistance to galling. As plated, cadmium has a silvery appearance. A subsequent chromic acid passivation bath creates a chromate topcoat over the cadmium, enhancing corrosion protection. Olive drab chromate is widely used, followed by gold chromate and clear chromate.

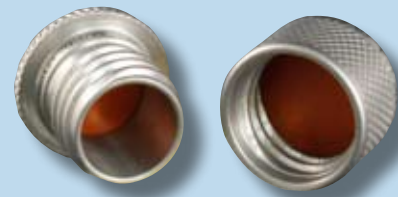

Stainless Steel

Cost	\$	\$	\$	\$	\$
Conductivity	+	+	+	+	+
Corrosion Resistance	⌚	⌚	⌚	⌚	⌚

-65 to +200°C

Glenair Code **Z1, ZL, ZW**

RoHS Compliant Stainless steel offers unbeatable strength and protection from environmental stress if durability and corrosion resistance are more important than cost and weight. Typically found on aircraft engines, landing gear, geophysical equipment, armored vehicles and marine applications, passivated stainless steel is widely specified in throughout the interconnect industry. Also offered with nickel and cadmium plating for improved conductivity, stainless steel is an obvious alternative to cadmium if cost and weight are not an issue.



Marine Bronze

Cost	\$	\$	\$	\$	\$
Conductivity	+	+	+	+	+
Corrosion Resistance	⌚	⌚	⌚	⌚	⌚

-65 to +200°C

Glenair Code **AB**

RoHS Compliant Marine bronze, an alloy of bronze, aluminum and nickel, is more resistant to the corrosive effects of seawater than ferrous alloys. Used on Glenair's GeoMarine connector coupling nuts, marine bronze is unplated and develops an aluminum oxide protective layer when exposed to air. Marine bronze connectors and accessories are found in shipboard and offshore drilling applications.



Plated Composite

Cost	\$	\$	\$	\$	\$
Conductivity	+	+	+	+	+
Corrosion Resistance	⌚	⌚	⌚	⌚	⌚

-65 to +200°C

Glenair Code **XM, XW, XMT**

RoHS Compliant Plated composite connectors and accessories provide unsurpassed corrosion protection and excellent conductivity. Glass-reinforced thermoplastic is metallized and plated with electroless nickel (olive drab cadmium is another popular finish). Plated composite connectors and accessories have become the first choice for aerospace programs seeking to eliminate cadmium and reduce weight.



Unplated Composite

Cost	\$	\$	\$	\$	\$
Conductivity	+	+	+	+	+
Corrosion Resistance	⌚	⌚	⌚	⌚	⌚

-65 to +175°C

Glenair Code **XB, XO**

RoHS Compliant If conductivity and EMI shielding are not required, unplated composites provide the best solution to corrosion protection. Glenair's composite connector accessories are ideally suited for use in harsh environments where even stainless steel parts can be attacked by corrosive fluids. Available in black (code XB) and brown (code XO).



AlumiPlateSM

Cost	\$	\$	\$	\$	\$
Conductivity	+	+	+	+	+
Corrosion Resistance	⌚	⌚	⌚	⌚	⌚

-65 to +175°C

Glenair Code **AL, XAL**

RoHS Compliant AlumiPlate provides excellent conductivity and corrosion resistance. 99.99% pure aluminum is electrolytically deposited onto aluminum in a specialized water-free process, followed by a trivalent chromate conversion coating. AlumiPlate has been approved by Boeing and Lockheed as a replacement for cadmium. AlumiPlate has been added to MIL-DTL-38999 and MIL-DTL-83513. Threaded parts require dry lube to prevent galling. AlumiPlate is a service mark of AlumiPlate Incorporated, Minneapolis, Minnesota.



Nickel-PTFE

Cost	\$	\$	\$	\$	\$
Conductivity	+	+	+	+	+
Corrosion Resistance	⌚	⌚	⌚	⌚	⌚

-65 to +175°C

Glenair Code **MT, XMT, ZMT**

RoHS Compliant Now approved for MIL-DTL-38999 and MIL-DTL-83513, Glenair's **1000 Hour Grey™** meets the need for a cadmium replacement with excellent conductivity, wear resistance and corrosion protection. This extremely durable finish is gun-metal gray. A proprietary preliminary undercoat is followed with a composite coating of electroless nickel phosphorus and polytetra-fluoroethylene (PTFE). An organic topcoat provides sealing and added resistance to SO₂ salt fog. Ni-PTFE is approved for the Joint Strike Fighter and offers extremely good lubricity.

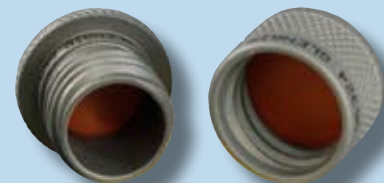

Hardcoat Anodize

Cost	\$	\$	\$	\$	\$
Conductivity	+	+	+	+	+
Corrosion Resistance	⌚	⌚	⌚	⌚	⌚

-65 to +200°C

Glenair Code **G2**

RoHS Compliant Hardcoat anodized aluminum offers greater wear resistance and better corrosion resistance compared to conventional anodizing. Typically employed when conductivity is not required, hardcoat aluminum offers good corrosion protection for marine and tactical applications. The resulting finish is a matte greenish-gray color. Hardcoat anodizing is an electrolytic process that creates aluminum oxide films by oxidizing the base metal in a sulfuric acid solution. The parts are immersed in a sulfuric acid solution at cold temperature. After anodizing, the parts can be dyed black (code GB).

Active Versus Noble Metals in Interconnect Systems

Metal materials used in manufacturing have different electrochemical potentials. Even so-called “pure” metals have inherent differences in electrochemical potential at the microscopic level. This is why a block of steel sitting all by itself corrodes. The order in which metals will corrode is always from the most anodic (active) to the most cathodic (noble). When two dissimilar metals are put together, only the more anodic metal will corrode. The magnitude of potential difference between the two metals, and which of the metals has the more negative potential, will determine which metal will be the cathode, which will be the anode, and the rate at which corrosion will occur.

Aluminum, bronze and stainless steel are all common material choices in interconnect hardware. Tin-plated copper wire is the most common material for RFI/EMI shielding, together with nickel-plated copper and silver-plated copper wire. Cadmium over nickel plating, the standard “W” finish specification called out in MIL-C-85409, is by far the most

common metallic surface finish, followed closely by commercial combinations of zinc, nickel and copper. It should be readily apparent that with this broad range of metal types in use, an interconnect system is a dissimilar metal accident just waiting to happen. The dissimilar metal problem is compounded by the unfortunate porosity of plated surfaces and the potential for protective plating to be scratched or damaged in handling. Both situations allow for electrolytic coupling of the base metal to its cadmium and nickel plating, which eventually results in catastrophic corrosion of the base material.

As mentioned, the obvious solution is to transition from metal materials to composite. But for all metal systems, the preferred approach is to select metal material combinations which are at least compatible within an index of .25 volts on the galvanic table. When this maximum is adhered to, the sacrificing of less-noble metals to more-noble metals is controlled, and components will survive the 500 hour salt fog minimum exposure required by military standards. Please consult the factory for additional information.

GALVANIC TABLE				
GROUP	MATERIAL	EMF (Volts)	ANODIC INDEX (.01V)	COMPATIBLE COUPLES @ .25V
–	Titanium and Cobalt Plate	+ .10	5	
3	Silver Plate	0	15	
4	Monel and Nickel Plate	.15	30	
5	Copper	.20	35	
7	Bronze and Brass	.30	45	
8	18-8 SST	.35	50	
10	Tin Plate	.50	65	
14	Aluminum	.75	90	
15	Cadmium Plate	.80	95	
17	Zinc Plate	1.10	125	

New Non-Toxic Plating Choices Available Now @ Glenair

At present, Glenair's customers specify cadmium plating on parts more often than any other finish treatment. Although cadmium plating is exempted under the Restrictions of Hazardous Substances (RoHS), there continues to be considerable impetus in the military and industrial sectors to reduce use of cadmium and other common plating substances, such as hexavalent chromium.

The Joint Group on Pollution Prevention (JG-PP), a partnership between the Military Services, NASA, DLA, and DCMA, appointed a Joint Cadmium Alternatives Team (JCAT) and sponsored a Hexavalent Chromium Coating Alternatives Technology Survey to find replacements for these two substances. Thus far, efforts to identify cadmium substitutes have proven more successful than hexavalent chromium replacements. Not surprisingly, any material active enough to provide corrosion control has high potential to also be a health and environmental hazard.

Cadmium plating offers interconnect designers excellent corrosion resistance, lubricity, solderability, adhesion and ductility. The main drawback of cadmium is its purported toxicity. The search for cadmium alternatives has been challenging, as replacements need to provide simultaneously 1) lubrication and consistent friction control, 2) protection to substrate aluminum or alloy steel from corrosion, 3) a barrier coating base, and 4) galvanic protection for compatibility between dissimilar metals such as aluminum and steel.

Cadmium replacement options often require a post-treatment chromate conversion coating for enhanced appearance and additional corrosion protection. The best choice for conversions is hexavalent chromium. Conversion coatings without hexavalent chromium are available, and they can yield

fair salt spray results, but they generally lack hexavalent chromium's self-healing property.

Newer trivalent chromium conversions in combination with rare earth metals such as vanadium show promise to match the performance of traditional hexavalent chromium processes, but not without significant drawbacks. Trivalent chromate requires additional controls, increasing its expense. Originally thought to be non-toxic, chromium in the trivalent variety can oxidize to the toxic hexavalent form at a rate of 7% to 10% when exposed to air, and at even greater rates in ground water.

Glenair has offered cadmium-free zinc nickel for some time, and now offers AlumiPlate and a nickel-PTFE plating superior to standard nickel-fluorocarbon polymer finish treatments. Both AlumiPlate and Ni-PTFE (see next page) are free of cadmium and hexavalent chromium.

AlumiPlateSM

AlumiPlate aluminum coating provides excellent conductivity and corrosion protection particularly in salt and other acidic environments. The AlumiPlate layer is pore free and provides a robust physical barrier. The pure aluminum coating forms a thin, tenacious, non-degenerating oxide almost immediately upon contact with air. This aluminum layer acts to "heal" scratches or impingements on an ongoing basis.

Typically a 0.5 mil AlumiPlate aluminum coating (with no chromate conversion) will provide over 1,200 hours of ASTM B117 salt spray resistance. It also protects from galvanic corrosion in steel-to-aluminum (and various other dissimilar metals-to-aluminum) applications.

Unlike many conventional platings which are destroyed or lost at higher temperatures, AlumiPlate aluminum offers good protection for base metals in extremely high temperature applications, as the melting point of aluminum is 1,220°F (660° C).

1000 Hour Grey™

The Advanced Formula Ni-PTFE Plating Process for EMC Applications

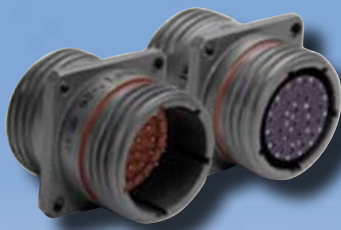

**New Cadmium Free
RoHS Compliant
Plating Process Breaks
1000 Hour Corrosion
Protection Barrier!**

The MIL-DTL-38999 Rev. L detail specification establishes several new cadmium-free conductive plating options including high-performance nickel-fluorocarbon polymer. The Glenair advanced formula **1000 Hour Grey™** plating process (Ni-PTFE) meets all D38999 performance requirements including a shell-to-shell conductivity maximum 2.5 millivolt drop potential.

1000 Hour Grey™ delivers outstanding performance in a broad range of land, sea, air and space interconnect applications. The non-reflective, non-magnetic, gun-metal gray surface finish is an ideal choice for tactical military systems with extraordinary corrosion protection and EMC requirements.

Advanced Durability, Lubricity Plus Outstanding Temperature Resistance!

The mechanical, electrical and environmental performance of **1000 Hour Grey™** is truly outstanding, far surpassing that of other metal alloy/fluorocarbon polymer plating solutions:

- 1000+ Hrs. Salt Spray
- Max 2.5 Millivolt Drop Potential
- -65°C to 175°C Temp. Rating
- 336+ Hrs. Sulfur Dioxide Resistance
- Non-Magnetic
- Cadmium Free
- Low Coefficient of Friction
- Hexavalent Chromium Free
- Potassium Formate Resistant
- Low Shell-to-Shell Resistance
- Adheres to Composite Plastic
- 500+ Mating Cycles
- Low Outgassing
- Available Now!



INCH - POUND

SPECIFICATION GMF-002
10 OCTOBER 2008

SUPERCEDING
9 OCTOBER 2008

SPECIFICATION

CORROSION-RESISTANT, CONDUCTIVE NICKEL-PTFE COATINGS FOR ALUMINUM, COMPOSITE AND STAINLESS STEEL CONNECTORS AND ACCESSORIES



Approved

A handwritten signature in blue ink, appearing to read 'Greg Brown'.

Greg Brown, V.P. Glenair Engineering

DISTRIBUTION STATEMENT: General release, unlimited distribution. This document does not contain export-controlled technical data or Glenair proprietary information. License is granted to Glenair customers for unrestricted use of this information.

© 2008 Glenair, Inc. All Rights Reserved.

1 SCOPE

1.1 Scope. This specification covers high-performance nickel-fluorocarbon coatings for electrical connector and accessory applications. These coatings are designed to meet the requirements of MIL-DTL-38999L (Plating type T).

1.2 Classification. The nickel-fluorocarbon coatings are of the following types and classes.

1.2.1 Types

Type I – as coated

Type II – with supplementary organic nanocoat

1.2.2 Classes

Class 1- Nickel-PTFE over Nickel-alloy underplate, total buildup 0.0010-0.0015, for use on machined aluminum base metal.

Class 2 - Nickel-PTFE over Nickel-alloy underplate over copper plate, total buildup 0.0010-0.0015, for use on die-cast aluminum and composite thermoplastic

Class 3 - Nickel-PTFE over Nickel-alloy over Nickel strike, total buildup 0.0010-0.0015, for use on cast or machined corrosion-resistant steel base metal.

Class 4 – Nickel-PTFE over Nickel-alloy underplate, total buildup 0.0005-0.0008, for use on MIL-DTL-83513 connectors and other high-precision components.

2 APPLICABLE DOCUMENTS

2.1 Specifications and standards. The following specifications and standards form a part of this document to the extent specified herein.

ASTM B117 Operating Salt Spray (Fog) Apparatus

ASTM B487 Measurement of Metal and Oxide Coating, Thickness by Microscopic Examination of a Cross Section, Method of

ASTM B567 Measurement of Coating Thickness by the Beta Backscatter Method

ASTM B568 Measurement of Coating Thickness by X-Ray Spectrometry

MIL-DTL-38999 Connectors, Electrical, Circular, General Specification for

MIL-STD-202 Test Methods for Electronic and Electrical Component Parts.

2.2 Order of precedence. In the event of a conflict between the requirements of this specification and the references cited herein, this document takes precedence.

3 REQUIREMENTS

3.1 Materials and Processing. Coating materials shall meet the chemical and physical requirements specified in Glenair GPS52 (Proprietary). Processes shall conform to GPS-52.

3.1.1 RoHS Compliance. Materials shall meet the requirements of European Union Directive 2002/95/EC. Materials shall not contain lead, cadmium, hexavalent chromium or other restricted materials.

- 3.2 Pre-Treatment. Parts, prior to coating, shall be free of oil, dirt, and all foreign material. Parts shall be cleaned in accordance with Glenair GPS52 (proprietary).
- 3.3 Appearance. The coating shall be continuous, smooth, fine grained, and free from visible blisters, pits, nodules, porosity, cracks and other defects. The coating shall be non-reflective, dull grey in color. Superficial staining as a result of rinsing, or slight discoloration resulting from drying or baking operations shall not be cause for rejection.
- 3.4 Adhesion. The coating adhesion after completion of all processing steps shall be such that when examined at a magnification of 4X, the coating shall not show separation from the basis metal when tested in accordance with ASTM B571. The test specimen shall be bent 180° over a mandrel with a diameter 4 times the specimen thickness (0.4 inch minimum).
- 3.5 Thickness. The plating thickness shall be uniform on significant surfaces. Slight buildup on corners and edges is permitted. Plating buildup on interior surfaces, holes and recesses shall not be required to meet minimum thickness specifications. If minimum plating thicknesses are required on interior surfaces, the engineering drawing shall specify the requirement.
Plating Thickness on Significant Exterior surfaces
Class 1, 2, and 3: 0.0010 minimum, 0.0015 maximum.
Class 4: 0.0005 minimum, 0.0008 maximum.
- 3.6 Corrosion Resistance. Coated specimens shall be subjected to a 5% neutral salt-spray test in accordance with ASTM B117. Type II finishes shall be subjected to continuous exposure to a 5% acidic (SO₂) salt spray in accordance with ASTM G85 A4. Any corrosion site where basis material is exposed and visible with the naked eye shall be considered a cause for rejection. A corrosion site shall be considered a failure of it is larger than .025 in size and occurs on critical areas of plated parts. White corrosion products shall not be cause for rejection.

Table 1: Corrosion Resistance

Class	Type	Basis Material	ASTM B117 Salt Spray Hours	ASTM G85 A4 SO ₂ Salt Spray Hours	Glenair Plating Code
1	I	Aluminum	1000	Not Required	Not Assigned
1	II	Aluminum	1000	336	MT
2	I	Composite	2000	Not Required	Not Assigned
2	I	Cast Aluminum	500	Not Required	Not Assigned
2	II	Composite	2000	336	XMT
2	II	Cast Aluminum	500	168	MT
3	I	CRES	1000	Not Required	Not Assigned
3	II	CRES	1000	336	ZMT
4	I	Aluminum	500	Not Required	Not Assigned
4	II	Aluminum	500	336	MT1

- 3.7 Conductivity. Parts shall be capable of meeting the conductivity requirements of the applicable connector specifications.
- 3.8 Marking Permanency. Coated parts shall meet the marking permanency test of MIL-STD-202 Method 215 when imprinted with epoxy-based ink.

- 3.9 Solderability. Coated parts shall be solderable using 60/40 tin/lead solder.
- 3.10 Temperature. Coated parts shall exhibit no deterioration or delamination of plating when exposed to continuous operation from -65°C to +175° C for Type II finishes, and -65° to +200 C for Type I finishes.
- 4 QUALITY ASSURANCE PROVISIONS
- 4.1 Control Records. Records shall be maintained for each processing bath. These records shall show modifications to the baths by adding chemicals and solutions, periodic analysis of the baths, and a record of the lots and quantity of parts plated. These records shall be maintained for a period of not less than one year.
- 4.2 Quality Conformance Inspection. Quality conformance inspections shall consist of non-destructive production lot inspection, periodic destructive adhesion tests, and periodic corrosion tests.
- 4.2.1 Production Lot Inspection (non-destructive). Random samples from each homogeneous production lot shall be examined visually and tested for thickness. The number of samples shall be in accordance with MIL-STD-105, inspection Level II with an acceptable quality level (AQL) of 1.5 percent defective.
- 4.2.1.1 Visual Inspection. Samples shall be examined for compliance with the requirements of 3.3.
- 4.2.1.2 Thickness of Plating. Samples shall be inspected and the plating thickness measured using a suitable non-destructive method such as the beta backscatter method of ASTM B487 or the x-ray spectrometry method of ASTM B568. Measurements shall be taken at several locations on significant surfaces. The shall be considered nonconforming if one or more measurements fail to meet the minimum thickness specified in 3.5. If the number of non-conforming items exceeds the acceptance number for the specified lot, the lot shall be rejected.
- 4.2.2 Periodic Tests. Adhesion and corrosion resistance shall be verified with periodic inspections conducted on aluminum alloy specimen strips approximately 1 inch wide, 4 inches long and 0.04 inch thick. Specimen strips shall be plated concurrently with production lots.
- 4.2.2.1 Frequency of Tests. Periodic tests shall be conducted on a monthly basis, with a maximum interval of 35 days between tests.
- 4.2.2.2 Periodic Test Sample Size. Four specimen strips shall be used for each test.
- 4.2.2.3 Periodic Adhesion Test. Coated specimen strips shall be tested to meet the requirement of 3.4.
- 4.2.2.4 Periodic Corrosion Test. Coated specimen strips shall be tested to meet the requirement of 3.6 except 500 hours duration. SO₂ salt fog shall not be required for periodic testing.
- 4.3 Qualification Inspection. Qualification testing shall be performed to verify compliance with the requirements of this specification and the requirements of MIL-DTL-38999L. Testing shall include the qualification tests specified in MIL-DTL-38999L Table XII Group 9, the plating adhesion test defined in MIL-DTL-38999L 4.5.5, and the SO₂ salt fog test defined in ASTM G85 A4.

5 NOTES

- 5.1 **Intended Use.** This coating was developed to meet the requirements of the aerospace/defense industry for a highly conductive, corrosion-resistant alternative to cadmium plating. This coating is suitable for use on most Glenair products including, but not limited to, electrical connectors, cable clamps, protective covers, backshells, and conduit fittings. This coating meets the requirements of MIL-DTL-38999L plating type T.
- 5.2 **Temperature Range.** MIL-DTL-38999 specifies a maximum temperature of +200° C for Ni-PTFE letter code T finish. Exposure to continuous temperature over +175° will result in lower resistance to SO₂ salt fog, but will not compromise compliance with MIL-DTL-38999.
- 5.3 **Dissimilar Metals.** Galvanically incompatible finishes should not be in intimate contact. Ni-PTFE finishes, like electroless nickel finishes, are galvanically incompatible with cadmium finishes. Users should exercise caution when specifying incompatible finishes on connectors and accessories.

The Glenair **MT** nickel fluorocarbon polymer plating has been assigned the **XMT** code in the plating tables for Glenair composite thermoplastic connector accessories. Here are just some of the key performance attributes for this finish when applied to our standard 30% glass-filled PEI composite material :

Temperature Resistance: Glenair's **XMT Ni-PTFE 1000 Hour Grey™** finish is rated from -65°C to +175°C.

Plating adhesion: When tested as specified in 3.4, there shall be no blistering, peeling, flaking or separation of plating or other damage detrimental to the operation of the part.

Dissimilar metals and compatible couples: The **1000 Hour Grey™** finish satisfies prohibitions against dissimilar metal coupling as specified in MIL-STD-889.

Shell-to-shell conductivity (millivolts): The **XMT** finish is rated at 2.5 millivolt drop potential.

Sulfur Dioxide Resistance: The **XMT** finish passes the requisite 336 hours resistance to Sulfur Dioxide.

One More Shot

Most of you know I grew up in Boston as a loyal fan of all the big Boston teams. Next to the Boston College Eagles, one of my all-time favorite teams is the Boston Celtics. And Larry Bird, the “Hick from French Lick,” is easily my favorite Celtic player. Bird was truly one of basketball’s greatest natural talents: His knack for recognizing and remembering the moves of opponents and teammates prompted coach Bill Fitch to nickname him “Kodak,” for his photographic memory of all the action on the court. But even more impressive than his natural ability, Larry Bird was also one of the hardest working professionals ever to play the game.

I have a fabulous newspaper clipping about Bird, in which he explains his extraordinary work ethic: “Growing up, my family didn’t have a whole lot. But we worked hard and made the most of what we had. Which, I believe, is what made me the ball player I am. Because it made me stay after practice and shoot foul shots. Maybe a thousand a day. It made me learn how to pass. How to play defense. While other guys were spending time learning how to dunk, I would practice the pick and roll. Or the give and go. Then I’d shoot more foul shots. I had a coach who told me that no matter how much I practiced, there was always another kid out there, somewhere, practicing longer. ***Well, I always made sure I took one more shot than that kid.***”

All human beings are creatures of habit. Bird made it a habit to practice the key skills that would make him the best in his game. But more importantly, when Bird made a habit of taking “one more shot” than the other guy, he made a conscious decision to pit himself against the entire universe of all possible ball players—not just the guys in his current league. This notion leads me to the point I would like to impress upon all of you: At Glenair, we define our universe of possible markets and competitors with the broadest possible boundaries. As hard as we are working, you can be sure that somewhere out there some “kid” is taking more “practice shots” than we are. Never fall into the trap of believing we don’t need to keep working hard on our game, just because we are doing fine against our current list of competitors. Bird never did. Neither should we.

Christopher J. Toomey
President

Publisher

Christopher J. Toomey

Executive Editor

Marcus Kaufman

Managing Editor

Carl Foote

Deputy Editor

Alex Boone

Art Director

Charles W. Belsler

Technical Consultant

Jim Donaldson

Issue Contributors

Greg Brown

Mussadiq Hussain

David Laliberte

Jim Plessas

Tom Young

Distribution

Terry White

QwikConnect is published quarterly by Glenair, Inc. and printed in the U.S.A. All rights reserved. © Copyright 2009 Glenair, Inc. A complete archive of past issues of *QwikConnect* is available on the Internet at www.glenair.com/qwikconnect

GLENAIR, INC.

1211 AIR WAY
GLENDALE, CA 91201-2497
TEL: 818-247-6000
FAX: 818-500-9912
EMAIL: sales@glenair.com
www.glenair.com

