

643710-4 ✓ ACTIVE

## MTA 156

TE Internal #: 643710-4

Rectangular Power Connectors, Header, Plug, Wire-to-Board, 14 Position, 3.96 mm [.156 in] Centerline, Printed Circuit Board, UL 94V-0, MTA 156

[View on TE.com >](#)



Connectors > Power Connectors > Rectangular Power > Rectangular Power Connectors

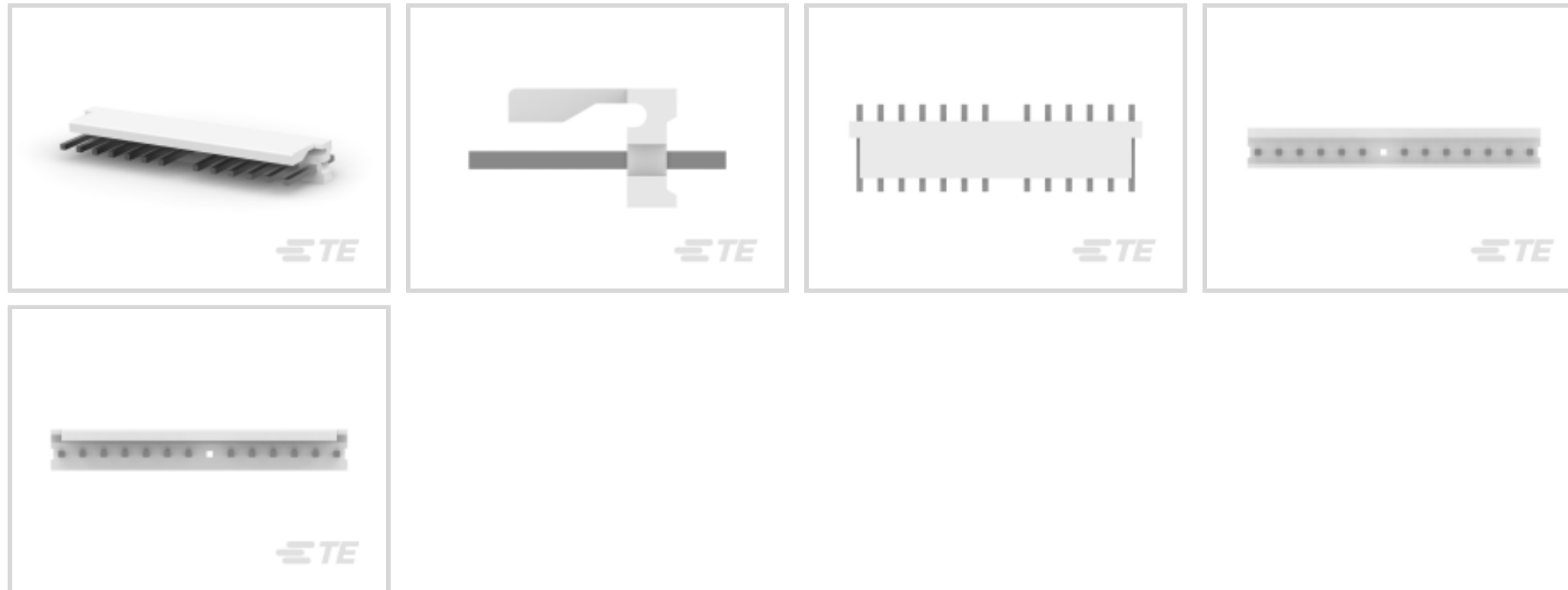

Rectangular Power Connector Type: **Header**

Connector & Housing Type: **Plug**

Connector System: **Wire-to-Board**

Number of Positions: **14**

Centerline (Pitch): **3.96 mm [.156 in]**

## Features

### Product Type Features

Header Type	Partially Shrouded
Rectangular Power Connector Type	Header
Connector & Housing Type	Plug
Connector System	Wire-to-Board
Sealable	No
Connector & Contact Terminates To	Printed Circuit Board

### Configuration Features

Number of Loaded Positions	13
Number of Positions	14
PCB Mount Orientation	Vertical
Number of Power Positions	14
Number of Rows	1

### Electrical Characteristics

Operating Voltage	600 VAC
-------------------	---------



### Contact Features

Mating Post Length	10.16 mm[.4 in]
Contact Layout	Inline
Contact Mating Area Plating Material	Tin
Contact Underplating Material	Nickel
Contact Base Material	Copper Alloy
Contact Current Rating (Max)	7 A
Contact Retention Within Housing	Without
Contact Type	Pin
PCB Contact Termination Area Plating Material	Tin
Contact Mating Area Plating Material Thickness	2.54 $\mu$ m[100 $\mu$ in]

### Termination Features

Termination Post & Tail Length	3.81 mm[.15 in]
Termination Method to Printed Circuit Board	Through Hole - Solder

### Mechanical Attachment

Strain Relief	Without
Mating Retention	With
Mating Alignment	Without
PCB Mount Alignment	Without
Panel Mount Feature	Without
PCB Mount Retention	Without
Mating Retention Type	Friction Lock
Connector Mounting Type	Board Mount

### Housing Features

Centerline (Pitch)	3.96 mm[.156 in]
Housing Color	Natural
Housing Material	Polyester - GF

### Dimensions

Connector Height	10.8 mm
PCB Thickness (Recommended)	1.57 – 2.36 mm[.062 – .093 in]
Product Length	55.47 mm

### Usage Conditions



Operating Temperature Range	-55 – 105 °C[-67 – 221 °F]
-----------------------------	----------------------------

### Operation/Application

Circuit Application	Power
---------------------	-------

### Industry Standards

CSA Rating	Certified, LR 7189
UL Rating	Recognized
Compatible With Agency/Standards Products	CSA, UL
Compatible With Approved Standards Products	UL E28476
UL Flammability Rating	UL 94V-0
Glow Wire Rating	Standard Part - Not Glow Wire

### Packaging Features

Packaging Quantity	1000
Packaging Method	Package

### Other

Number of Blocked Positions	1
-----------------------------	---

## Product Compliance

[For compliance documentation, visit the product page on TE.com>](#)

EU RoHS Directive 2011/65/EU	Compliant
EU ELV Directive 2000/53/EC	Compliant
China RoHS 2 Directive MIIT Order No 32, 2016	No Restricted Materials Above Threshold
EU REACH Regulation (EC) No. 1907/2006	Current ECHA Candidate List: JUNE 2024 (241) Candidate List Declared Against: JUNE 2024 (241) Does not contain REACH SVHC
Halogen Content	Not Low Halogen - contains Br or Cl > 900 ppm.
Solder Process Capability	Wave solder capable to 265°C

#### Product Compliance Disclaimer

This information is provided based on reasonable inquiry of our suppliers and represents our current actual knowledge based on the information they provided. This information is subject to change. The part numbers that TE has identified as EU RoHS compliant have a maximum concentration of 0.1% by weight in homogenous materials for lead, hexavalent chromium, mercury, PBB, PBDE, DBP, BBP, DEHP, DIBP, and 0.01% for cadmium, or qualify for an exemption to these limits as defined in the Annexes of Directive 2011/65/EU (RoHS2). Finished electrical and electronic equipment products will be CE marked as required by Directive 2011/65/EU. Components may not be CE marked. Additionally, the part numbers that TE has identified as EU ELV compliant have a maximum concentration of 0.1% by weight in homogenous



materials for lead, hexavalent chromium, and mercury, and 0.01% for cadmium, or qualify for an exemption to these limits as defined in the Annexes of Directive 2000/53/EC (ELV). Regarding the REACH Regulation, the information TE provides on SVHC in articles for this part number is based on the latest European Chemicals Agency (ECHA) 'Guidance on requirements for substances in articles' posted at this URL: <https://echa.europa.eu/guidance-documents/guidance-on-reach>

## Compatible Parts



TE Part # 1-640445-4  
14P MTA156 HDR ASSY FL/STR SN



TE Part # 640629-1  
MTA156 KEYING PLUG



TE Part # 1-640551-4  
14P MTA156 COVER



TE Part # 1-643071-4  
14P MTA156 FD-THRU COVER



TE Part # 1-643067-4  
14P MTA156 MOLDED COVER



TE Part # CAT-103156-WBHSN  
Receptacle Housing: Wire-to-Board, no Mating Alignment, SL 156



TE Part # 4-643818-4  
14P MTA156 CONN ASSY 20AWG YEL



TE Part # 4-643817-4  
14P MTA156 CONN ASSY 18AWG LF



TE Part # 1-640643-4  
14P MTA156 COVER F/T



TE Part # 4-643819-4  
14P MTA156 CONN ASSY 22AWG LF

## Also in the Series | MTA 156



Connector Caps & Covers(89)



Connector Contacts(4)



Connector Hardware(2)



Insertion & Extraction Tools(1)

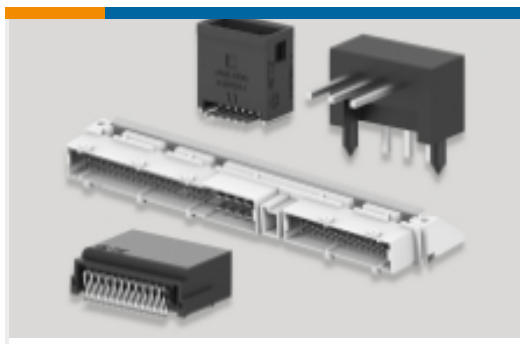

PCB Headers &amp; Receptacles(317)



Rectangular Power Connectors(691)



Standard Rectangular Connectors(336)

## Customers Also Bought

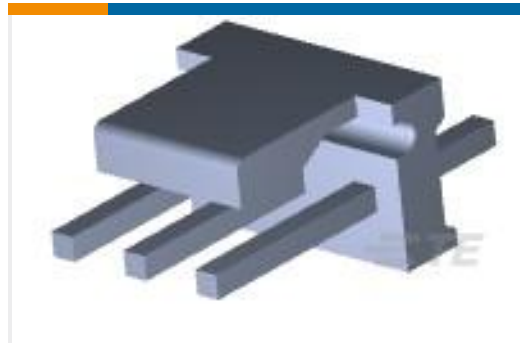
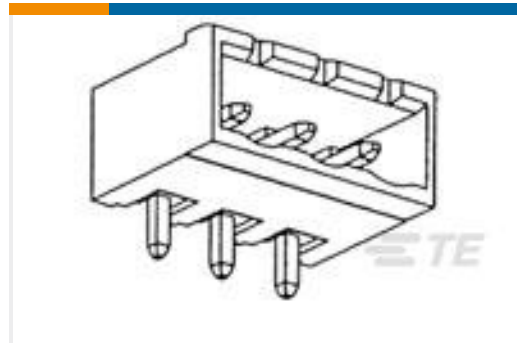
TE Part #640454-3  
03P MTA100 HDR ASSY SQ STR POLTE Part #644752-3  
03P MTA156 HDR ASSY SQ STR F/LTE Part #796638-4  
4POS 5.08MM CE R/A HDR, TRM BLKTE Part #5-146282-1  
01 MODII HDR SRST B/A .100CL

## Documents

### Product Drawings

#### 14P MTA156 HDR ASSY W/O#7

English

### CAD Files

#### Customer View Model

[ENG\\_CVM\\_CVM\\_643710-4\\_M.2d\\_dxf.zip](#)

English

#### 3D PDF

3D

#### Customer View Model

[ENG\\_CVM\\_CVM\\_643710-4\\_M.3d\\_igs.zip](#)

English

#### Customer View Model

[ENG\\_CVM\\_CVM\\_643710-4\\_M.3d\\_stp.zip](#)

English

By downloading the CAD file I accept and agree to the [Terms and Conditions](#) of use.

### Product Specifications

#### Application Specification

English

### Agency Approvals

#### Agency Approval Document

English

643710-4

Rectangular Power Connectors, Header, Plug, Wire-to-Board, 14 Position, 3.96 mm [.156 in] Centerline, Printed Circuit Board, UL 94V-0, MTA 156

