

PLEASE CHECK WWW.MOLEX.COM FOR LATEST PART INFORMATION

Part Number: [63902-9900](#)
Status: **Active**
Description: FineAdjust™ Applicator for SolderRight™ In-Board Terminals

Documents:

[RoHS Certificate of Compliance \(PDF\)](#)

General

Product Family	Application Tooling
Series	T9999
Function	Crimp
Geographic Area	Global
Level of Automation	Automatic
More Detailed Tech Information	applicationtooling@molex.com
Product Name	FineAdjust™
Survey	www.molex.com//review/apptool_survey.html
Tool Type	Applicator
UPC	887191620619

Material Info

Reference - Drawing Numbers

Application Tooling Documents	ATS-639029900
-------------------------------	---------------

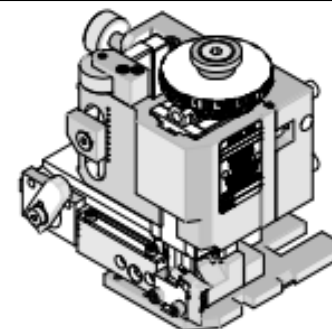

Series

image - Reference only

EU RoHS

**ELV and RoHS
Compliant**

REACH SVHC

Not Reviewed

Low-Halogen Status

Not Reviewed

China RoHS



**Need more information on product
environmental compliance?**

Email productcompliance@molex.com
For a multiple part number RoHS Certificate of
Compliance, [click here](#)

Please visit the [Contact Us](#) section for any
non-product compliance questions.

Search Parts in this Series

[T9999Series](#)

Use With

Molex TM-3000™: 63801-7200 ,
63801-7300 , Molex TM-4000™:
63801-7600 , Molex TM-2000™:
63800-8300 , 63800-8400 , and Most
Industry Standard Presses or Wire Process
Machines