







61800860	DATA SHEET	
Valid from: 03.07.2018	SILVYN® KLICK PG	

SILVYN® KLICK-GP is a straight, one piece conduit gland with push-in closure for quick secure assembly. Dismantle by sliding the locking sleeve. The gland is suitable for conduit type SILVYN® RILL.



- Material:** Body - PA
Seal - TPE
- Features:** Push-In-Lock
For coarse and fine profile conduits
Simple dismounting
High mechanical stress
- Resistant:** To fuels, mineral oil, fat, alkalizes, glycols, acids, bases and common solvents
- Temperature range:** -40°C up to +115°C
- Colour:** Grey
Black (UV-Resistant)
- Norm Reference:**



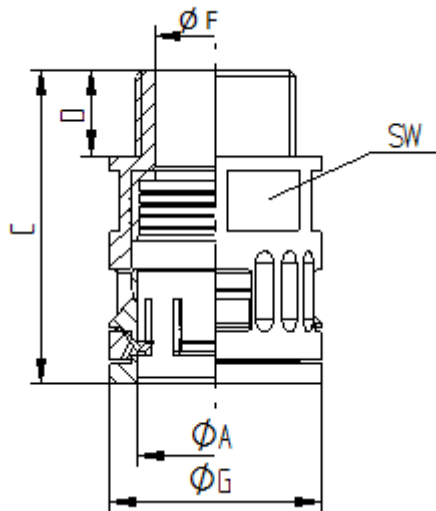

 UL FILENUMBER E308201
- Note:** Self-extinguishing HB acc. to UL94
Free of silicone, cadmium and halogen
- Protection class:** IP 68 acc. to EN 60529
IP 69 K Type-tested by VDE acc. to DIN 40050 T.9

Creator: M. Wegerer /PDP Released: DAMU1/PDP	Document: DB61800860EN Version: 06	Page 1 of 2
---	---------------------------------------	-------------

61800860	DATA SHEET	
Valid from: 03.07.2018	SILVYN® KLICK PG	



Dimensions table:

Part no.	Part name	Thread	SW	Article Designation Ø A mm	Outer Ø G mm	Inner Ø F mm	Length C mm	Thread length D mm
Grey								
6180 0860	SILVYN® KLICK PG	PG 7	16	10	17	7	32,5	10
6180 0870	SILVYN® KLICK PG	PG 9	18	13	20	10	35	10
6180 0880	SILVYN® KLICK PG	PG 11	21	15,8	23	12,5	37	10
6180 0850	SILVYN® KLICK PG	PG13,5	24	18,5	26	13,5	43	13
6180 0890	SILVYN® KLICK PG	PG 16	27	21,2	29,5	17	46	13
6180 0900	SILVYN® KLICK PG	PG 21	34	28,5	37	23,5	48,5	12,5
6180 0910	SILVYN® KLICK PG	PG 29	40	34,5	44	30	53,5	14,5
6180 0920	SILVYN® KLICK PG	PG 36	60	42,5	63	36	76	17
6180 0930	SILVYN® KLICK PG	PG 48	70	54,5	74	47,5	88	17
Black								
6180 0865	SILVYN® KLICK PG	PG 7	16	10	17	7	32,5	10
6180 0875	SILVYN® KLICK PG	PG 9	18	13	20	10	35	10
6180 0885	SILVYN® KLICK PG	PG 11	21	15,8	23	12,5	37	10
6180 0855	SILVYN® KLICK PG	PG13,5	24	18,5	26	13,5	43	13
6180 0895	SILVYN® KLICK PG	PG 16	27	21,2	29,5	17	46	13
6180 0905	SILVYN® KLICK PG	PG 21	34	28,5	37	23,5	48,5	12,5
6180 0915	SILVYN® KLICK PG	PG 29	40	34,5	44	30	53,5	14,5
6180 0925	SILVYN® KLICK PG	PG 36	60	42,5	63	36	76	17
6180 0935	SILVYN® KLICK PG	PG 48	70	54,5	74	47,5	88	17

For more information please see our current catalogue. Please do not hesitate to contact our laboratory if there are any questions regarding resistance against aggressive agents and special oil.

Creator: M. Wegerer /PDP Released: DAMU1/PDP	Document: DB61800860EN Version: 06	Page 2 of 2
---	---------------------------------------	-------------