

REVISIONS			
REV	DESCRIPTION	DATE	APPROVED
-	NEW RELEASE PER E.O. C6776	011019	C.F.

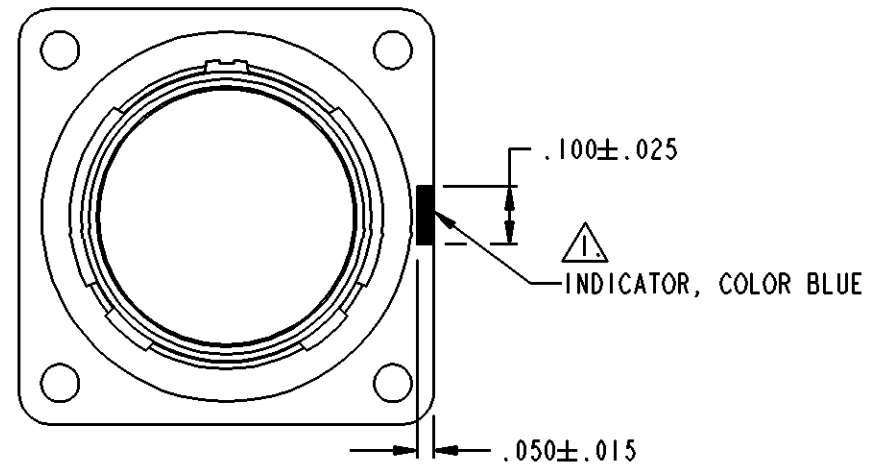
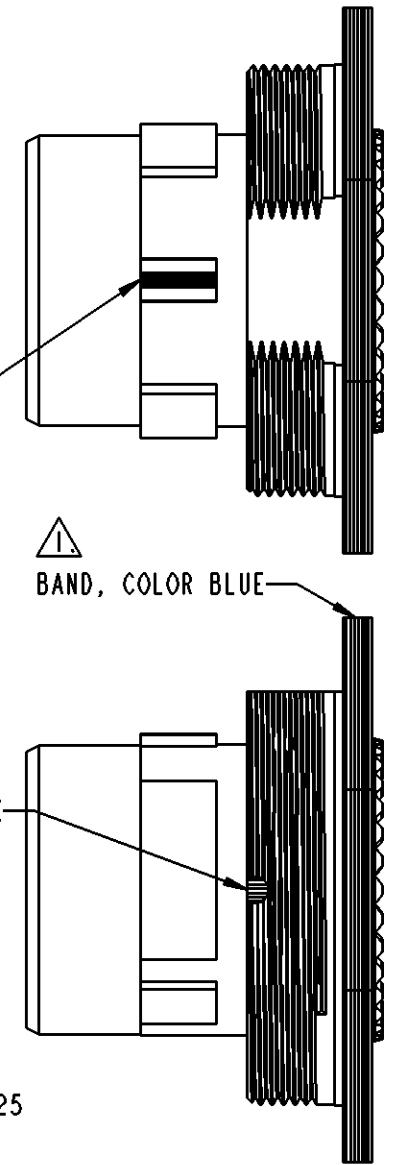
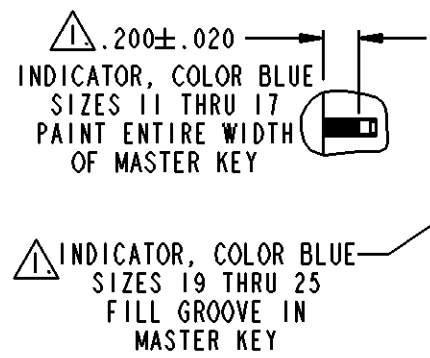
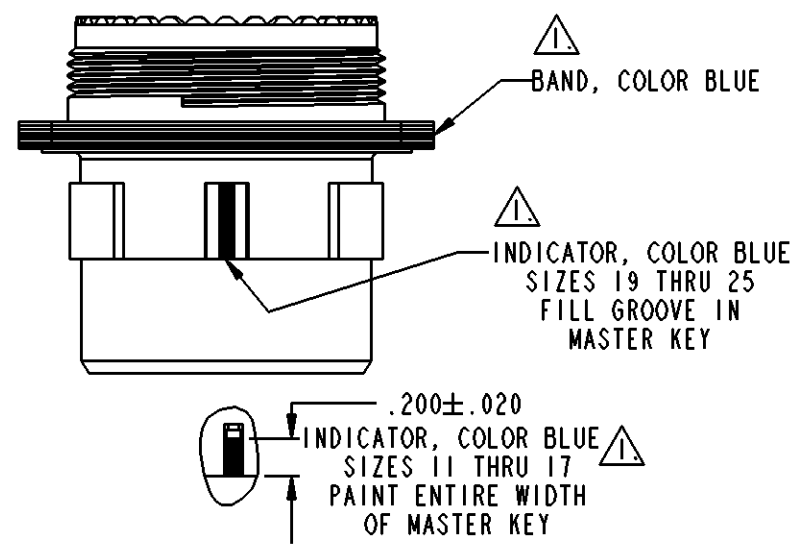

(\*\*)<sub>1</sub> - SIZE 11, 13, 15, 17, 19, 21, 23 AND 25

⚠ AFTER PLATING TO CORRECT PLATING LIST NUMBER, PAINT COLOR BAND AND INDICATOR AS SHOWN PER DPS 1-141-17, TYPE VII, CLASS 1, COLOR BLUE.

UNLESS OTHERWISE SPECIFIED: DIMENSIONS ARE IN INCHES DECIMALS TO ± .005 ANGLES ± 30° T.I.R. .010 PARTS TO HAVE NO BURRS OR SHARP EDGES MATERIAL ALUM ALLOY 6061-T6 PER DMS 2-037-01 FINISH (**) <sub>2</sub> = DPS #1 APPLIES	SIGNATURE & DATE	
	DR	D. WHITACRE 011016
	CHK	C.F. 011019
	PE	D. WHITACRE 011016
	APPD	EHAN LATIF 070907
	SCALE	NONE WT

SHELL, RECEPTACLE  
 SQ FLG & JAM NUT MOUNTING  
 BREECH LOCK COUPLING  
 DIV SERIES  
 PLATED AND PAINTED FOR DISTRIBUTION  
 INFORMATION

CP	MATL CODE 61
<b>DEUTSCH</b> ENGINEERED CONNECTING DEVICES 5733 W. Whittier Ave. Hemet, California	
<b>A</b> DWG SIZE	6131-201/220-(**) <sub>1</sub> (**) <sub>2</sub> P
CODE 11139	SHEET 1 OF 1

6131-201-220-XXXX

# Mouser Electronics

Authorized Distributor

Click to View Pricing, Inventory, Delivery & Lifecycle Information:

[TE Connectivity:](#)

[6131-212-25149P](#)