

IEC Appliance Inlet C18, Snap-in Mounting, Front Side, Solder or Quick-connect Terminal



6102-5



Approvals and Compliances

Description

- Panel Mount :
 Snap-in version from front side
- 1 Function :
- Appliance Inlet , Pin temperature 70 °C , Protection class II
- Solder terminals or quick connect terminals

Other versions on request

- Other panel thickness
- Types for enhanced glow wire test requirements acc. IEC 60695-2-12 and -13 for the use in unattended household equipment acc. IEC 60335-1

References

- Alternative: Version in protection class I [6100-4](#)
- Alternative: version with line filter [5120](#)

Weblinks

[pdf datasheet](#), [html-datasheet](#), [General Product Information](#), [Distributor-Stock-Check](#), [Accessories](#), [Detailed request for product](#)

Technical Data

Ratings IEC	10A / 250VAC; 50Hz
Ratings UL/CSA	15A / 250VAC; 60Hz
Dielectric Strength	> 2kVAC between L-N (1 min/50Hz)
Allowable Operation Temperature	-25 °C to 70 °C
IP-Protection	from front side IP 30 acc. to IEC 60529
Insulation cover	Suitable for appliances with protection class II acc. to IEC 61140
Terminal	Solder terminals or quick connect terminals
Panel Thickness S	Snap-in: 1/1.2/1.5/2/2.5/3 mm
Material: Housing	Thermoplastic, black, UL 94V-0

appliance inlet/-outlet	C18 acc. to IEC 60320-1, UL 60320-1, CSA C22.2 no. 60320-1 (for cold conditions) pin-temperature 70 °C, 10A, Protection Class II
-------------------------	--

Approvals and Compliances

Detailed information on product approvals, code requirements, usage instructions and detailed test conditions can be looked up in [Details about Approvals](#)

Approvals



The approval mark is used by the testing authorities to certify compliance with the safety requirements placed on electronic products.

Approval Reference Type: 6102-5

Approval Logo	Certificates	Certification Body	Description
	VDE Approvals	VDE	Certificate Number: 40015595
	UL Approvals	UL	UL File Number: E96454
	CQC Approvals	CQC	CCC File Number:



Product standards

Product standards that are referenced

Organization	Design	Standard	Description
	Designed according to	IEC 60320-1	Appliance couplers for household and similar general purposes
	Designed according to	UL 60320-1	Standard for Attachment Plugs and Receptacles
	Designed according to	CSA C22.2 no. 60320-1	General Use Receptacles, Attachment Plugs, and Similar Wiring Devices





Application standards

Application standards where the product can be used

Organization	Design	Standard	Description
	Designed for applications acc.	IEC/UL 60950	IEC 60950-1 includes the basic requirements for the safety of information technology equipment.
	Designed for applications acc.	IEC 60335-1	Safety of electrical appliances for household and similar purposes. Meets the requirements for appliances in unattended use. This includes the enhanced requirements of glow wire tests acc. to IEC 60695-2-12 and -13.

Compliances

The product complies with following Guide Lines

Identification	Details	Initiator	Description
	CE declaration of conformity	SCHURTER AG	The CE marking declares that the product complies with the applicable requirements laid down in the harmonisation of Community legislation on its affixing in accordance with EU Regulation 765/2008.
	RoHS	SCHURTER AG	EU Directive RoHS 2011/65/EU
	China RoHS	SCHURTER AG	The law SJ / T 11363-2006 (China RoHS) has been in force since 1 March 2007. It is similar to the EU directive RoHS.
	REACH	SCHURTER AG	On 1 June 2007, Regulation (EC) No 1907/2006 on the Registration, Evaluation, Authorization and Restriction of Chemicals 1 (abbreviated as "REACH") entered into force.

Dimensions [mm]

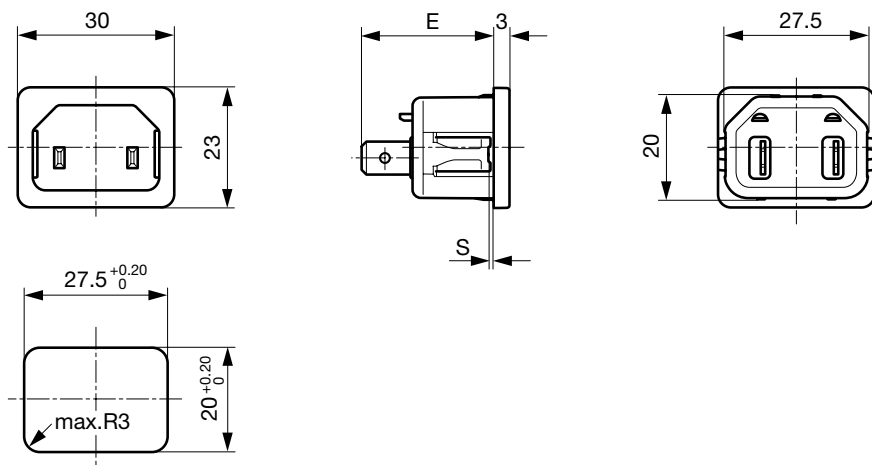

E: Solder terminals 22.5 mm

E: Quick connect terminals 25.5 mm

S: 1.0; 1.2; 1.5; 2.0; 2.5; 3.0 mm

All Variants

Type	Protection Class	Panel mounting	Panel Thickness s [mm]	Terminal	Order Number
6102-5	II	Snap-in	1.5	Quick connect terminals 4.8 x 0.8 mm	6102.5215
6102-5	II	Snap-in	2	Quick connect terminals 4.8 x 0.8 mm	6102.5220
6102-5	II	Snap-in	2.5	Quick connect terminals 4.8 x 0.8 mm	6102.5225
6102-5	II	Snap-in	3	Quick connect terminals 4.8 x 0.8 mm	6102.5230
6102-5	II	Snap-in	1	Quick connect terminals 6.3 x 0.8 mm	6102.5310
6102-5	II	Snap-in	1.2	Quick connect terminals 6.3 x 0.8 mm	6102.5312

Type	Protection Class	Panel mounting	Panel Thickness s [mm]	Terminal	Order Number
6102-5	II	Snap-in	1.5	Quick connect terminals 6.3 x 0.8 mm	6102.5315
6102-5	II	Snap-in	2	Quick connect terminals 6.3 x 0.8 mm	6102.5320
6102-5	II	Snap-in	2.5	Quick connect terminals 6.3 x 0.8 mm	6102.5325
6102-5	II	Snap-in	3	Quick connect terminals 6.3 x 0.8 mm	6102.5330
6102-5	II	Snap-in	1	Solder terminals 3.8 x 0.8 mm	6102.5110
6102-5	II	Snap-in	1.2	Solder terminals 3.8 x 0.8 mm	6102.5112
6102-5	II	Snap-in	1.5	Solder terminals 3.8 x 0.8 mm	6102.5115
6102-5	II	Snap-in	2.5	Solder terminals 3.8 x 0.8 mm	6102.5125
6102-5	II	Snap-in	3	Solder terminals 3.8 x 0.8 mm	6102.5130

Availability for all products can be searched real-time: <https://www.schurter.com/en/Stock-Check/Stock-Check-SCHURTER>

Articles for enhanced glow wire test requirements acc. IEC 60695-2-12 and -13 can be ordered with ending ".15" (xxxx.xxxx.15). They are suitable for the use in unattended household equipment acc. IEC 60335-1.

Packaging unit 50 Pcs

Accessories

Description

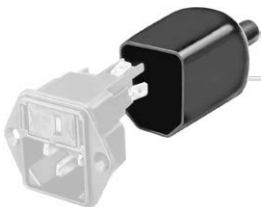

Assorted Covers
Rear Cover

0859.0048

4311.9401

4311.9402



Cord retaining kits
Cord retaining strain relief

Countersunk, C

4700.0003

Mating Outlets/Connectors

Category / Description

[Connector Overview complete](#)



4782 Mounting: Power Cord, 3 x 1 mm² / 3 x 18 AWG, Cable, Connector: IEC C13

4782

4022 Mounting: Power Supply Cord, 3 x 1.5 mm², Screw clamps, Connector: IEC C13

4022

4785 Mounting: Power Cord, 3 x 1 mm² / 3 x 18 AWG, Cable, Connector: IEC C13

4785

4300-06 Mounting: Power Cord, 3 x 1 mm² / 3 x 18 AWG, Cable, Connector: IEC C13

4300-06

4012 Mounting: Power Supply Cord, 3 x 1.5 mm², Screw clamps, Connector: IEC C13

4012

[Connector further types to 6102-5](#)

...

Mating Outlets/Connectors shuttered



[Power Cord Overview complete](#)

Power cord with IEC connector C17, V-Lock, straight

VAC17KS

[Power Cord further types to 6102-5](#)