

TOZ 12VDC 48VDC0,1A

Weidmüller Interface GmbH & Co. KG
 Klingenbergstraße 26
 D-32758 Detmold
 Germany

www.weidmueller.com

Product image

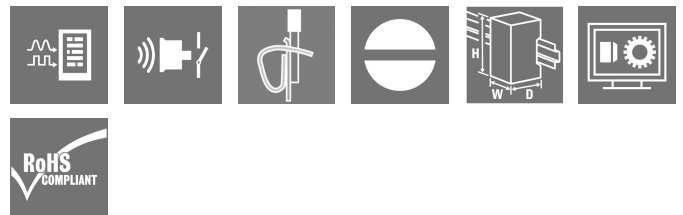
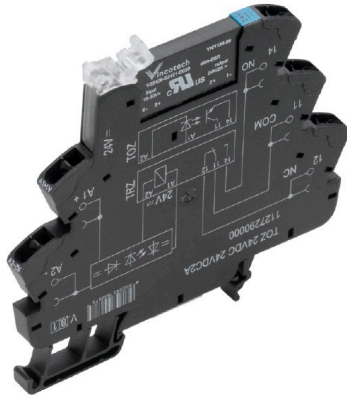

Similar to illustration

- 1 NO contact (Bipolar transistor)
- 6.4 mm wide
- 0.1 A DC output current
- Unique multi-voltage input from 24 to 230 V UC
- Input voltages from 12 V DC to 230 V UC with coloured marking: AC: red, DC: blue, UC: white

General ordering data

Version	TERMSERIES, Solid-state relay, Rated control voltage: 12 V DC $\pm 20\%$, Rated switching voltage: 3... 48 V DC, Continuous current: 0.1 A, Tension-clamp connection
Order No.	1127040000
Type	TOZ 12VDC 48VDC0,1A
GTIN (EAN)	403224890872 1
Qty.	10 items

TOZ 12VDC 48VDC0,1A

Weidmüller Interface GmbH & Co. KG

Klingenbergstraße 26

D-32758 Detmold

Germany

www.weidmueller.com

Technical data

Approvals

Approvals



ROHS Conform

UL File Number Search [UL Website](#)

Certificate no. (cULus) E141197

Dimensions and weights

Depth	87.8 mm	Depth (inches)	3.4567 inch
Height	90.5 mm	Height (inches)	3.563 inch
Width	6.4 mm	Width (inches)	0.252 inch
Net weight	29.9 g		

Temperatures

Storage temperature	-40 °C...70 °C	Ambient temperature	-20 °C...60 °C
Operating temperature		Humidity	5-95% relative humidity, Tu = 40°C, without condensation

Probability of failure

MTTF 3026 a

Environmental Product Compliance

RoHS Compliance Status	Compliant with exemption
RoHS Exemption (if applicable/known)	7a, 7cl
REACH SVHC	Lead 7439-92-1
SCIP	9e2cbc49-76d9-4611-b8ec-5b4f549a0aa9

Rated data UL

Ambient temperature (operational), max.	60 °C	Connection cross-section AWG, min.	AWG 26
Connection cross-section AWG, max.	AWG 14	Type of conductor	rigid copper conductor, flexible copper conductor
Pollution severity level	2		

Control side

Rated control voltage	12 V DC \pm 20 %	Nominal control current	5 mA DC (\pm 20 %)
Power rating	112 mW	Status indicator	Green LED
Protective circuit	Rectifier	Input frequency	10 Hz
Coil voltage of the replacement relay deviating from the rated control voltage	Yes	Coil voltage of the replacement relay	5 V DC

Load side

Rated switching voltage	3... 48 V DC	Continuous current	0.1 A
Rated switching current	100 mA	Switch-on delay	\leq 0.4 ms
Switch-off delay	\leq 3 ms	Voltage drop at max. load	\leq 1 V
Leakage current	<10 μ A	Min. switching current	500 μ A

TOZ 12VDC 48VDC0,1A

Weidmüller Interface GmbH & Co. KG
 Klingenbergstraße 26
 D-32758 Detmold
 Germany

www.weidmueller.com

Technical data

Short-circuit-proof	No	Protective circuit, load side	Free-wheeling diode
Contact type	1 NO contact (Bipolar transistor)	max. switching frequency (DC control voltage)	10 Hz

General data

Mounting rail	TS 35		
Test button available	No		
Colour	black		
UL94 flammability rating component	Component	Housing	
	UL94 flammability rating	V-0	
	Component	Retaining clip	
	UL94 flammability rating	V-0	

Insulation coordination

Rated voltage	300 V	Pollution severity	2
Surge voltage category	III	Clearance and creepage distances for control side - load side	≥ 5.5 mm
Dielectric strength for control side - load side	2.5 kVeff	Dielectric strength to mounting rail	4 kVeff / 1 Min.
Impulse withstand voltage	6 kV (1.2/50 µs)	Protection degree	IP20

Further details of approvals / standards

Certificate No. (DNV)	TAA00001E5	Certificate no. (cULus)	E141197
-----------------------	------------	-------------------------	---------

Connection data

Wire connection method	Tension-clamp connection	Stripping length, rated connection	8 mm
Clamping range, rated connection	1.5 mm ²	Clamping range, min.	0.14 mm ²
Clamping range, max.	2.5 mm ²	Wire connection cross section AWG, min.	AWG 26
Wire connection cross section AWG, max.	AWG 14	Wire cross-section, solid, min.	0.14 mm ²
Wire cross-section, solid, max.	2.5 mm ²	Wire cross-section, solid, min. (AWG)	AWG 26
Wire cross-section, solid, max. (AWG)	AWG 14	Wire connection cross section, finely stranded, min.	0.14 mm ²
Wire connection cross section, finely stranded, max.	2.5 mm ²	Wire cross-section, finely stranded, min. (AWG)	AWG 26
Wire cross-section, finely stranded, max. (AWG)	AWG 14	Wire connection cross-section, finely stranded with wire-end ferrules DIN 46228/4, min.	0.14 mm ²
Wire connection cross-section, finely stranded with wire-end ferrules DIN 46228/4, max.	1.5 mm ²	Conductor cross-section, flexible, AEH (DIN 46228-1), min.	0.14 mm ²
Conductor cross-section, flexible, AEH (DIN 46228-1), max.	1.5 mm ²	Blade size	0.6 x 3.5 mm

Classifications

ETIM 6.0	EC001504	ETIM 7.0	EC001504
ETIM 8.0	EC001504	ETIM 9.0	EC001504
ETIM 10.0	EC001504	ECLASS 9.0	27-37-16-04
ECLASS 9.1	27-37-16-04	ECLASS 10.0	27-37-16-04
ECLASS 11.0	27-37-16-04	ECLASS 12.0	27-37-16-04
ECLASS 13.0	27-37-16-04	ECLASS 14.0	27-37-16-04
ECLASS 15.0	27-37-16-04		

TOZ 12VDC 48VDC0,1A

Weidmüller Interface GmbH & Co. KG
Klingenbergstraße 26
D-32758 Detmold
Germany

www.weidmueller.com

Drawings

Wiring diagram

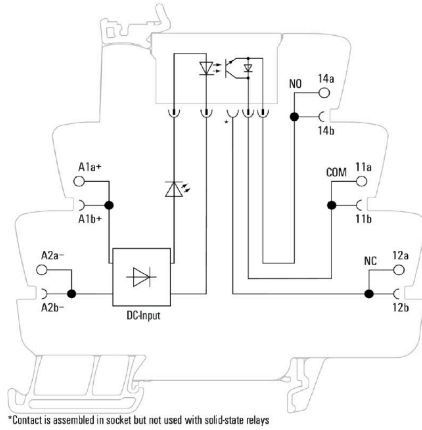

Dimensional drawing

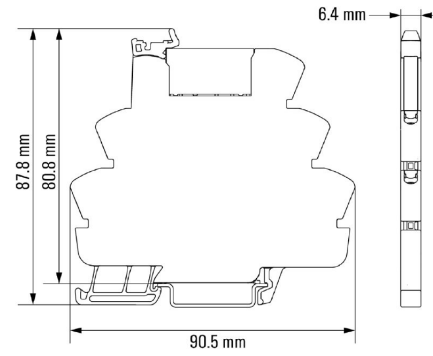

Miscellaneous

Type code TERMSERIES solid-state relay versions

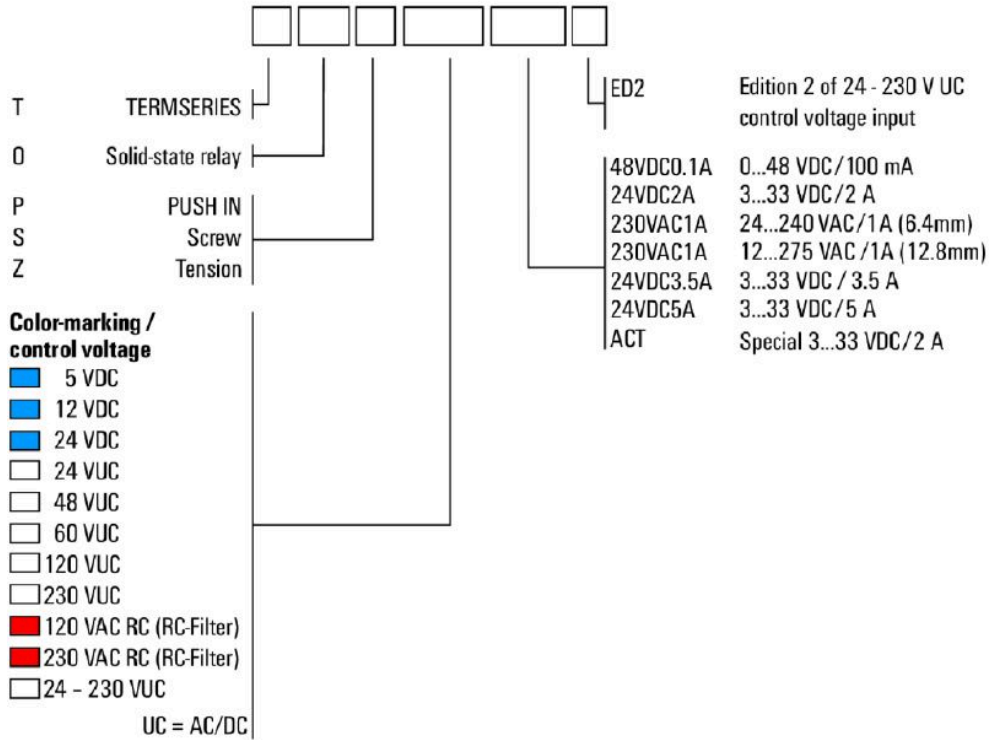

Type codes

TOZ 12VDC 48VDC0,1A

Weidmüller Interface GmbH & Co. KG
 Klingenbergstraße 26
 D-32758 Detmold
 Germany

www.weidmueller.com

Accessories

Partition plate



Versatile separation plates

Separation plates can be used to group together signals visually, to electrically isolate modules and to insert markings for a better overview. This makes them a particularly versatile accessory. Separation plates increase the clearance and creepage distances between two modules, thus increasing the rated insulation voltage between two modules to up to 600 V. Double separation plates can be marked with WAD5 or WS10/5 markers and enable continuous cross-connections. Installation is made easier with the perforations to individually break out the cross-connection channels.

- Partition plates visually separates groups from each other
- Indentations for individual breaking out the crossconnection channels
- Partition plates isolates between two modules by increasing the clearance and creepage distances of up to 600 V

General ordering data

Type	TW TXS/TXZ R3.2	Version	
Order No.	1240800000	TERMSERIES, Partition plate	
GTIN (EAN)	4050118028188		
Qty.	10 ST		

Supply module



Space-saving supply modules

Our supply terminals enable potentials to be fed at the input – e.g. neutral or minus potentials – or switched potentials to be fed at the output. In conjunction with precisely fitting cross-connections from the TERMSERIES, the connections for the cables on the relay module remain free for actuators or sensors. No additional feed-through terminal blocks are required, resulting in huge space savings in the panel. At the same time, the wiring is simplified as no double wire-end ferrules are required for the potential feed.

General ordering data

Type	TXP SUPPLY	Version	
Order No.	2618940000	TERMSERIES, Supply module, Number of contacts: 5, , Continuous current: 10 A, PUSH IN	
GTIN (EAN)	4050118667592		
Qty.	10 ST		

TOZ 12VDC 48VDC0,1A

Weidmüller Interface GmbH & Co. KG
 Klingenbergstraße 26
 D-32758 Detmold
 Germany

www.weidmueller.com

Accessories

Type	TXS SUPPLY	Version
Order No.	1240780000	TERMSERIES, Supply module, Number of contacts: 5, , Continuous
GTIN (EAN)	4050118028140	current: 10 A, Screw connection
Qty.	10 ST	
Type	TXZ SUPPLY	Version
Order No.	1240790000	TERMSERIES, Supply module, Number of contacts: 5, , Continuous
GTIN (EAN)	4050118028164	current: 10 A, Tension-clamp connection
Qty.	10 ST	

Blank

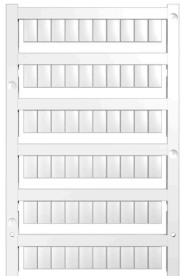

WS markers are the perfect match for the W-series connectors. Thanks to their system compatibility, the WS tags can also be used with the I-series and the Z-series. The large marking surfaces do not only permit long character strings but also multi-line text. WS markers are ideal for labels with long, customised character strings. Thanks to the proven MultiCard format, printing with PrintJet CONNECT oder/or Plotter is possible.

- Can be fitted in strips or individually
- Markers in proven MultiCard format

For custom printing: Please send us a file of our labeling software M-Print PRO or M-Print PRO Online (without installation) for your labeling specifications.

General ordering data

Type	WS 10/6 M MC NE WS	Version
Order No.	1818400000	WS, Terminal marker, 10 x 6 mm, Pitch in mm (P): 6.00 Weidmueller,
GTIN (EAN)	4032248310876	Allen-Bradley, white
Qty.	600 ST	

ZQV

General ordering data

Type	ZQV 1.5N/R6.4/2 GE	Version
Order No.	1193670000	TERMSERIES, Cross-connector
GTIN (EAN)	4032248976638	
Qty.	10 ST	
Type	ZQV 1.5N/R6.4/10 GE	Version
Order No.	1193680000	TERMSERIES, Cross-connector
GTIN (EAN)	4032248976454	
Qty.	10 ST	

TOZ 12VDC 48VDC0,1A

Weidmüller Interface GmbH & Co. KG
 Klingenbergstraße 26
 D-32758 Detmold
 Germany

www.weidmueller.com

Accessories

Type	ZQV 1.5N/R6.4/19 GE	Version
Order No.	1193690000	TERMSERIES, Cross-connector
GTIN (EAN)	4032248976645	
Qty.	10 ST	
Type	ZQV 1.5N/R6.4/2 BL	Version
Order No.	1446140000	TERMSERIES, Cross-connector
GTIN (EAN)	4050118251074	
Qty.	10 ST	
Type	ZQV 1.5N/R6.4/10 BL	Version
Order No.	1390350000	TERMSERIES, Cross-connector
GTIN (EAN)	4050118190793	
Qty.	10 ST	
Type	ZQV 1.5N/R6.4/19 BL	Version
Order No.	1391620000	TERMSERIES, Cross-connector
GTIN (EAN)	4050118191813	
Qty.	10 ST	
Type	ZQV 1.5N/R6.4/2 RT	Version
Order No.	1446090000	TERMSERIES, Cross-connector
GTIN (EAN)	4050118250886	
Qty.	10 ST	
Type	ZQV 1.5N/R6.4/10 RT	Version
Order No.	1391640000	TERMSERIES, Cross-connector
GTIN (EAN)	4050118191660	
Qty.	10 ST	
Type	ZQV 1.5N/R6.4/19 RT	Version
Order No.	1391610000	TERMSERIES, Cross-connector
GTIN (EAN)	4050118191783	
Qty.	10 ST	
Type	ZQV 1.5N/R6.4/2 SW	Version
Order No.	1446040000	TERMSERIES, Cross-connector
GTIN (EAN)	4050118251067	
Qty.	10 ST	
Type	ZQV 1.5N/R6.4/10 SW	Version
Order No.	1391630000	TERMSERIES, Cross-connector
GTIN (EAN)	4050118191776	
Qty.	10 ST	
Type	ZQV 1.5N/R6.4/19 SW	Version
Order No.	1391600000	TERMSERIES, Cross-connector
GTIN (EAN)	4050118191806	
Qty.	10 ST	

Slotted screwdriver



Slotted screwdriver with rounded blade SD DIN 5265,
 ISO 2380/2, output to DIN 5264, ISO 2380/1.
 ChromTop tip, SoftFinish grip

TOZ 12VDC 48VDC0,1A

Weidmüller Interface GmbH & Co. KG
 Klingenbergstraße 26
 D-32758 Detmold
 Germany

www.weidmueller.com

Accessories

General ordering data

Type	SDS 0.6X3.5X100	Version
Order No.	2749340000	Screwdriver, Blade width (B): 3.5 mm, Blade length: 100 mm, Blade thickness (A): 0.6 mm
GTIN (EAN)	4050118895568	
Qty.	1 ST	
Type	SDIS SLIM 0.6X3.5X100	Version
Order No.	2749610000	Mounting tool, Blade width (B): 3.5 mm, Blade length: 100 mm, Blade thickness (A): 0.6 mm
GTIN (EAN)	4050118896350	
Qty.	1 ST	

Angled slotted screwdriver



General ordering data

Type	SD TO 0,6X3,0	Version
Order No.	2749560000	Screwdriver, Blade width (B): 3 mm, Blade length: 70 mm, Blade thickness (A): 0.6 mm
GTIN (EAN)	4050118895889	
Qty.	1 ST	

Cross-connections



Adjustable cross-connections

Increase the flexibility of your cross-connections. The TERMSERIES CROSS-CONNECTION (TCC) enables individually adjustable cross-connections with up to 51 poles. The maximum number of pluggable poles has been increased to 32 poles. The strip material can be shortened to the required length very easily. The cross-connectors convince thanks to their easy handling and visibility as well as their universal connection possibilities. An additional web prevents the spring from deforming during assembly.

- Individually adjustable cross-connection with 51 poles
- Additional bar to avoid deformation of the spring
- Increased cross-connection – up to 32 poles possible
- Vibration resistance

General ordering data

Type	TCC 6.4/51 RD	Version
Order No.	2556410000	TERMSERIES, Cross-connector
GTIN (EAN)	4050118566925	
Qty.	10 ST	

TOZ 12VDC 48VDC0,1A

Weidmüller Interface GmbH & Co. KG
 Klingenbergstraße 26
 D-32758 Detmold
 Germany

www.weidmueller.com

Accessories

Type	TCC 6.4/51 OR	Version
Order No.	2556370000	TERMSERIES, Cross-connector
GTIN (EAN)	4050118566680	
Qty.	10 ST	
Type	TCC 6.4/51 BL	Version
Order No.	2556450000	TERMSERIES, Cross-connector
GTIN (EAN)	4050118566963	
Qty.	10 ST	
Type	TCC 6.4/51 BK	Version
Order No.	2556490000	TERMSERIES, Cross-connector
GTIN (EAN)	4050118567007	
Qty.	10 ST	
Type	TCC 6.4/2 OR	Version
Order No.	2556350000	TERMSERIES, Cross-connector
GTIN (EAN)	4050118566826	
Qty.	10 ST	
Type	TCC 6.4/2 BL	Version
Order No.	2556430000	TERMSERIES, Cross-connector
GTIN (EAN)	4050118566949	
Qty.	10 ST	
Type	TCC 6.4/2 BK	Version
Order No.	2556470000	TERMSERIES, Cross-connector
GTIN (EAN)	4050118566987	
Qty.	10 ST	
Type	TCC 6.4/10 RD	Version
Order No.	2556400000	TERMSERIES, Cross-connector
GTIN (EAN)	4050118566918	
Qty.	10 ST	
Type	TCC 6.4/10 OR	Version
Order No.	2556360000	TERMSERIES, Cross-connector
GTIN (EAN)	4050118566673	
Qty.	10 ST	
Type	TCC 6.4/10 BL	Version
Order No.	2556440000	TERMSERIES, Cross-connector
GTIN (EAN)	4050118566956	
Qty.	10 ST	
Type	TCC 6.4/10 BK	Version
Order No.	2556480000	TERMSERIES, Cross-connector
GTIN (EAN)	4050118566994	
Qty.	10 ST	
Type	TCC 12.8/26 RD	Version
Order No.	2556420000	TERMSERIES, Cross-connector
GTIN (EAN)	4050118566932	
Qty.	10 ST	
Type	TCC 12.8/26 OR	Version
Order No.	2556380000	TERMSERIES, Cross-connector
GTIN (EAN)	4050118566697	
Qty.	10 ST	
Type	TCC 12.8/26 BL	Version
Order No.	2556460000	TERMSERIES, Cross-connector
GTIN (EAN)	4050118566970	
Qty.	10 ST	

TOZ 12VDC 48VDC0,1A

Weidmüller Interface GmbH & Co. KG
 Klingenbergstraße 26
 D-32758 Detmold
 Germany

www.weidmueller.com

Accessories

Type	TCC 12.8/26 BK	Version
Order No.	2556500000	TERMSERIES, Cross-connector
GTIN (EAN)	4050118567014	
Qty.	10 ST	
Type	TCC 6.4/2 RD	Version
Order No.	2556390000	TERMSERIES, Cross-connector
GTIN (EAN)	4050118566901	
Qty.	10 ST	

Interface adapters

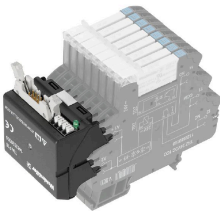

Faster signal wiring with less space

To reduce wiring times, pre-assembled cables are used between the control system and the interface level and are simply connected to the TERMSERIES adapter. This enables throughput times in electrical cabinet building to be significantly reduced. The adapter has a universal fit and offers a genuine space advantage in interaction with the TERMSERIES products with identical contours.

- Reduced wiring time due to plug-and-play concept with pre-assembled cables
- Can be applied to the input and output sides of the TERMSERIES
- Ready for plus and minus switching logic
- High space-saving due to universal fit to other TERMSERIES products

General ordering data

Type	TIA F10	Version
Order No.	1463520000	TERMSERIES, Adapter, 10-pole plug according to DIN EN 60603-13,
GTIN (EAN)	4050118323535	long locking lever, Number of signal paths: 8, Rated voltage DC : 24 V,
Qty.	1 ST	Rated current (per signal path): 125 mA
Type	TIA SUBD 15S	Version
Order No.	1463530000	TERMSERIES, Adapter, Sub-D, 15-pole, DIN 41652 / IEC 60807,
GTIN (EAN)	4050118323542	Number of signal paths: 8, Rated voltage DC : 24 V, Rated current (per
Qty.	1 ST	signal path): 125 mA
Type	TIAL F20	Version
Order No.	1463550000	TERMSERIES, Adapter, 20-pole plug according to DIN EN 60603-13,
GTIN (EAN)	4050118331783	long locking lever, Number of signal paths: 16, Rated voltage DC : 24
Qty.	1 ST	V, Rated current (per signal path): 60 mA