

PLEASE CHECK WWW.MOLEX.COM FOR LATEST PART INFORMATION

Part Number: [55935-0610](#)
Status: **Active**
Overview: [MicroClasp™](#)
Description: 2.00mm Pitch MicroClasp™ Wire-to-Board Header, Single Row, Right Angle, 6 Circuits, with PCB Locator

Documents:

[3D Model](#) [Product Specification PS-51382-004 \(PDF\)](#)
[Drawing \(PDF\)](#) [RoHS Certificate of Compliance \(PDF\)](#)

General

Product Family	PCB Headers
Series	55935
Application	Signal, Wire-to-Board
Overview	MicroClasp™
Product Name	MicroClasp™
UPC	800756632148

Physical

Breakaway	No
Circuits (Loaded)	6
Circuits (maximum)	6
Color - Resin	Natural
Durability (mating cycles max)	30
First Mate / Last Break	No
Glow-Wire Compliant	No
Guide to Mating Part	No
Keying to Mating Part	None
Lock to Mating Part	Yes
Material - Plating Mating	Tin
Material - Plating Termination	Tin
Material - Resin	Polyester
Net Weight	679.700/mg
Number of Rows	1
Orientation	Right Angle
PC Tail Length	3.20mm
PCB Locator	Yes
PCB Retention	Yes
PCB Thickness - Recommended	1.60mm
Packaging Type	Tray
Pitch - Mating Interface	2.00mm
Shrouded	Fully
Stackable	No
Surface Mount Compatible (SMC)	No
Temperature Range - Operating	-25°C to +85°C
Termination Interface: Style	Through Hole

Electrical

Current - Maximum per Contact	3A
Voltage - Maximum	250V

Material Info

Reference - Drawing Numbers

Product Specification	PS-51382-004, RPS-51382-006, RPS-51382-007, RPS-51382-008, RPS-51382-009, RPS-51382-010,
-----------------------	---

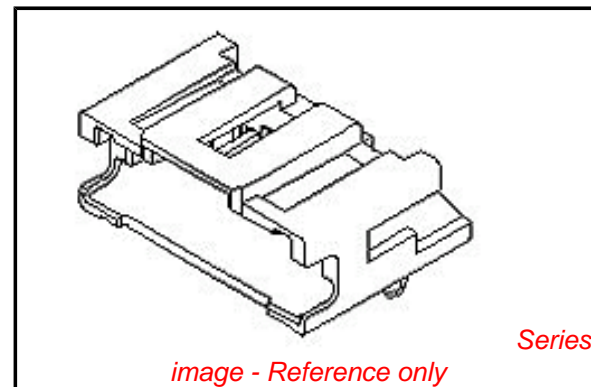

EU RoHS

**ELV and RoHS
Compliant**

REACH SVHC

Not Reviewed

Low-Halogen Status

Not Low-Halogen

China RoHS



**Need more information on product
environmental compliance?**

Email productcompliance@molex.com
For a multiple part number RoHS Certificate of Compliance, [click here](#)

Please visit the [Contact Us](#) section for any non-product compliance questions.

Search Parts in this Series

[55935Series](#)

Mates With

51382 MicroClasp™ Wire-to-Board
Receptacle Housing

Sales Drawing

RPS-51382-011, RPS-51382-012, RPS-51382-013,
RPS-51382-014, RPS-51382-015
SD-55935-005

This document was generated on 06/06/2013

PLEASE CHECK WWW.MOLEX.COM FOR LATEST PART INFORMATION