

PLEASE CHECK WWW.MOLEX.COM FOR LATEST PART INFORMATION

Part Number: [55917-2630](#)
Status: **Active**
Overview: [MicroClasp™](#)
Description: 2.00mm Pitch MicroClasp™ Wire-to-Board Header, Dual Row, Vertical, 26 Circuits, without PCB Locator

Documents:

[3D Model](#) [Product Specification PS-51353-003 \(PDF\)](#)
[Drawing \(PDF\)](#) [RoHS Certificate of Compliance \(PDF\)](#)

Agency Certification

UL E29179

General

Product Family PCB Headers
 Series [55917](#)
 Application Signal, Wire-to-Board
 Overview [MicroClasp™](#)
 Product Name MicroClasp™
 UPC 756054338995

Physical

Breakaway No
 Circuits (Loaded) 26
 Circuits (maximum) 26
 Color - Resin Natural
 Durability (mating cycles max) 30
 First Mate / Last Break No
 Flammability 94V-0
 Glow-Wire Compliant No
 Guide to Mating Part No
 Keying to Mating Part None
 Lock to Mating Part Yes
 Material - Plating Mating Tin
 Material - Plating Termination Tin
 Material - Resin Polyester
 Net Weight 1871.700/mg
 Number of Rows 2
 Orientation Vertical
 PC Tail Length 3.20mm
 PCB Locator No
 PCB Retention Yes
 PCB Thickness - Recommended 1.60mm
 Packaging Type Tray
 Pitch - Mating Interface 2.00mm
 Shrouded Fully
 Stackable No
 Surface Mount Compatible (SMC) No
 Temperature Range - Operating -25°C to +85°C
 Termination Interface: Style Through Hole

Electrical

Current - Maximum per Contact 3A
 Voltage - Maximum 250V

Material Info

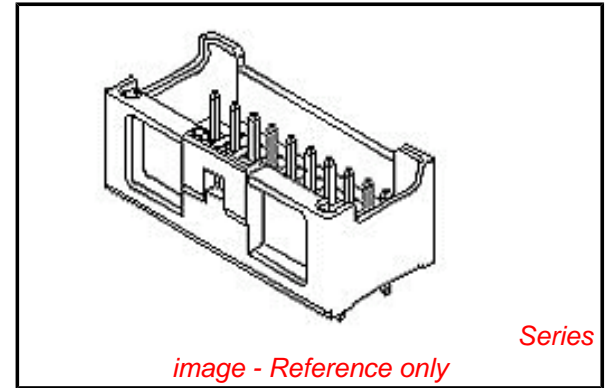

EU RoHS

ELV and RoHS Compliant
REACH SVHC Contains SVHC: No
Low-Halogen Status Not Low-Halogen

China RoHS



Need more information on product environmental compliance?

Email productcompliance@molex.com
 For a multiple part number RoHS Certificate of Compliance, [click here](#)

Please visit the [Contact Us](#) section for any non-product compliance questions.

Search Parts in this Series

[55917Series](#)

Mates With

[51353 MicroClasp™ Wire-to-Board Receptacle Housing](#)

Reference - Drawing Numbers

Product Specification

PS-51353-003, RPS-501844-001, RPS-51353-008,
RPS-51353-009, RPS-51353-014, RPS-51353-016,
RPS-51353-018, RPS-51353-019, RPS-51353-020,
RPS-51353-024, RPS-51353-025, RPS-51353-026,
RPS-51353-030
SD-55917-005

Sales Drawing

This document was generated on 06/06/2013

PLEASE CHECK WWW.MOLEX.COM FOR LATEST PART INFORMATION