

PLEASE CHECK WWW.MOLEX.COM FOR LATEST PART INFORMATION

Part Number: [0532660629](#)
Status: **Active**
Description: 7.00mm Pitch Header, Right-Angle, 6 Circuits

Documents:

[Drawing \(PDF\)](#) [Product Specification PS-51067-021-001 \(PDF\)](#)
[Product Specification PS-51067-007 \(PDF\)](#) [RoHS Certificate of Compliance \(PDF\)](#)
[Product Specification PS-51067-020-001 \(PDF\)](#)

Agency Certification

CSA LR19980
 UL E29179

General

Product Family PCB Headers
 Series [53266](#)
 Application Power, Wire-to-Board
 Product Name N/A
 UPC 822348210794

Physical

Breakaway No
 Circuits (Loaded) 6
 Circuits (maximum) 6
 Durability (mating cycles max) 30
 First Mate / Last Break No
 Flammability 94V-0
 Glow-Wire Capable No
 Guide to Mating Part No
 Keying to Mating Part None
 Lock to Mating Part Yes
 Mated Height 9.70mm
 Material - Metal Brass
 Material - Plating Mating Tin
 Material - Plating Termination Tin
 Net Weight 2655.200/mg
 Number of Rows 1
 Orientation Right Angle
 PC Tail Length 3.50mm
 PCB Locator Yes
 PCB Retention None
 PCB Thickness - Recommended 1.60mm
 Packaging Type Tray
 Pitch - Mating Interface 7.00mm
 Plating min - Mating 1.016µm
 Plating min - Termination 1.016µm
 Polarized to Mating Part Yes
 Polarized to PCB Yes
 Shrouded Fully
 Stackable No
 Temperature Range - Operating -40° to +105°C
 Termination Interface: Style Through Hole

Electrical

Current - Maximum per Contact 6.0A
 Voltage - Maximum 250V

Material Info

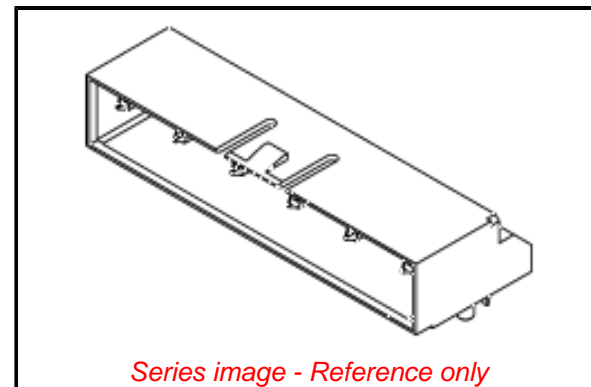

EU ELV

Not Relevant

EU RoHS

Compliant

REACH SVHC

Not Contained Per -
 D(2020)4578-DC (25
 June 2020)

Halogen-Free

Status

Not Low-Halogen

For more information, please visit [Contact US](#)

China ROHS

ELV

RoHS Phthalates

China RoHS

Green Image

Not Relevant

Not Contained

Search Parts in this Series

[53266 Series](#)

Mates With

[510671100 Wire-to-Board Crimp Housing](#)

Reference - Drawing Numbers

Product Specification

Sales Drawing

PS-51067-007, PS-51067-020-001, PS-51067-021-001

SD-53266-002

This document was generated on 10/21/2020

PLEASE CHECK WWW.MOLEX.COM FOR LATEST PART INFORMATION