

**PLEASE CHECK WWW.MOLEX.COM FOR LATEST PART INFORMATION**

**Part Number:** [0532660229](#)  
**Status:** **Active**  
**Description:** 7.00mm Pitch Header, Right-Angle, 2 Circuits

**Documents:**

[Drawing \(PDF\)](#) [Product Specification PS-51067-021-001 \(PDF\)](#)  
[Product Specification PS-51067-007 \(PDF\)](#) [RoHS Certificate of Compliance \(PDF\)](#)  
[Product Specification PS-51067-020-001 \(PDF\)](#)

**Agency Certification**

CSA LR19980  
 UL E29179

**General**

Product Family PCB Headers  
 Series [53266](#)  
 Application Power, Wire-to-Board  
 Product Name N/A  
 UPC 822348210756

**Physical**

Breakaway No  
 Circuits (Loaded) 2  
 Circuits (maximum) 2  
 Durability (mating cycles max) 30  
 First Mate / Last Break No  
 Flammability 94V-0  
 Glow-Wire Capable No  
 Guide to Mating Part No  
 Keying to Mating Part None  
 Lock to Mating Part Yes  
 Mated Height 9.70mm  
 Material - Metal Brass  
 Material - Plating Mating Tin  
 Material - Plating Termination Tin  
 Net Weight 929.700/mg  
 Number of Rows 1  
 Orientation Right Angle  
 PC Tail Length 3.50mm  
 PCB Locator Yes  
 PCB Retention None  
 PCB Thickness - Recommended 1.60mm  
 Packaging Type Tray  
 Pitch - Mating Interface 7.00mm  
 Plating min - Mating 1.016µm  
 Plating min - Termination 1.016µm  
 Polarized to Mating Part Yes  
 Polarized to PCB Yes  
 Shrouded Fully  
 Stackable No  
 Temperature Range - Operating -40° to +105°C  
 Termination Interface: Style Through Hole

**Electrical**

Current - Maximum per Contact 6.0A  
 Voltage - Maximum 250V

**Material Info**

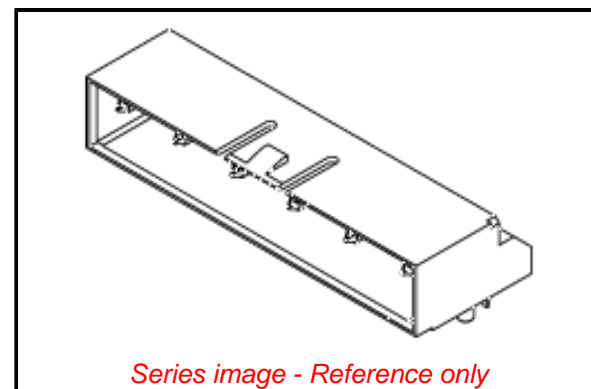

**EU ELV**

**Not Relevant**

**EU RoHS**

**Compliant**

**REACH SVHC**

Not Contained Per -  
 D(2020)4578-DC (25  
 June 2020)

**Halogen-Free**

**Status**

**Not Low-Halogen**

For more information, please visit [Contact US](#)

China ROHS

ELV

RoHS Phthalates

**China RoHS**

Green Image

Not Relevant

Not Contained

**Search Parts in this Series**

[53266 Series](#)

**Mates With**

[510670300 Wire-to-Board Crimp Housing](#)

**Reference - Drawing Numbers**

Product Specification

Sales Drawing

PS-51067-007, PS-51067-020-001, PS-51067-021-001

SD-53266-002

This document was generated on 10/21/2020

**PLEASE CHECK [WWW.MOLEX.COM](http://WWW.MOLEX.COM) FOR LATEST PART INFORMATION**