

PLEASE CHECK WWW.MOLEX.COM FOR LATEST PART INFORMATION

Part Number: [52892-1395](#)
Status: **Active**
Description: 0.50mm Pitch Easy-On™ Type FFC/FPC Connector, Right Angle, SMT, ZIF, Bottom Contact Style, Cable Retention Guide, 13 Circuits, Lead-Free

Documents:

[3D Model](#) [Product Specification PS-52892-038 \(PDF\)](#)
[Drawing \(PDF\)](#) [RoHS Certificate of Compliance \(PDF\)](#)

General

Product Family FFC/FPC Connectors
 Series [52892](#)
 Comments Hinge, Cable Guide
 Product Name Easy-On™
 UPC 822348116430

Physical

Circuits (Loaded) 13
 Color - Resin Natural
 Contact Position Bottom
 Durability (mating cycles max) 20
 Entry Angle 90° Angle
 Mated Height 2.00mm
 Material - Metal Phosphor Bronze
 Material - Plating Mating Tin-Bismuth
 Material - Plating Termination Tin-Bismuth
 Material - Resin High Temperature Thermoplastic
 Net Weight 163.292/mg
 Number of Rows 1
 Orientation Right Angle
 PCB Locator No
 PCB Retention Yes
 Packaging Type Embossed Tape on Reel
 Pitch - Mating Interface 0.50mm
 Plating min - Mating 1.016µm
 Plating min - Termination 1.016µm
 Polarized to PCB No
 Stackable No
 Surface Mount Compatible (SMC) N/A
 Temperature Range - Operating -25°C to +85°C
 Termination Interface: Style Surface Mount
 Wire/Cable Type FFC/FPC

Electrical

Current - Maximum per Contact 0.5A
 Voltage - Maximum 50V

Material Info

Reference - Drawing Numbers

Product Specification PS-52892-038, RPS-52892-036, RPS-52892-039,
 RPS-52892-045, RPS-52892-049, RPS-52892-052
 Sales Drawing SD-52892-040, SD-52892-041

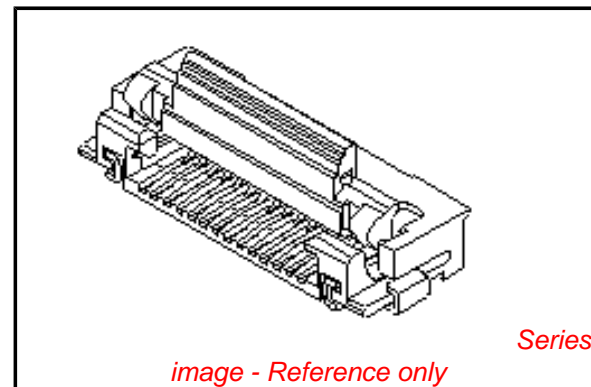

image - Reference only

EU RoHS

**ELV and RoHS
 Compliant**
**REACH SVHC
 Contains SVHC: No
 Low-Halogen Status
 Not Low-Halogen**

China RoHS



**Need more information on product
 environmental compliance?**

Email productcompliance@molex.com
 For a multiple part number RoHS Certificate of
 Compliance, [click here](#)

Please visit the [Contact Us](#) section for any
 non-product compliance questions.

Search Parts in this Series

[52892Series](#)

PLEASE CHECK WWW.MOLEX.COM FOR LATEST PART INFORMATION