

**PLEASE CHECK WWW.MOLEX.COM FOR LATEST PART INFORMATION**

**Part Number:** [52559-3033](#)  
**Status:** **Active**  
**Overview:** FFC-FPC (SMT)  
**Description:** Easy-On™ Type FFC/FPC Connector, Vertical, Surface Mount, ZIF, 30 Circuits, Lead-Free, with Tape Packaging Center Placement Holes

**Documents:**

[3D Model](#) [Packaging Specification SPK-52559-003 \(PDF\)](#)  
[Drawing \(PDF\)](#) [RoHS Certificate of Compliance \(PDF\)](#)  
[Product Specification PS-52559-019 \(PDF\)](#)

**Agency Certification**

UL E29179

**General**

Product Family FFC/FPC Connectors  
 Series [52559](#)  
 Overview [FFC-FPC \(SMT\)](#)  
 Product Name Easy-On™  
 UPC 887191289878

**Physical**

Circuits (Loaded) 30  
 Color - Resin Natural  
 Contact Position N/A  
 Durability (mating cycles max) 20  
 Entry Angle Vertical  
 Flammability 94V-0  
 Mated Height 3.90mm  
 Material - Metal Phosphor Bronze  
 Material - Plating Mating Silver, Tin-Bismuth  
 Material - Plating Termination Silver, Tin-Bismuth  
 Material - Resin Nylon  
 Net Weight 372.232/mg  
 Number of Rows 1  
 Orientation Vertical  
 PC Tail Length 2.00mm  
 PCB Locator No  
 PCB Retention Yes  
 Packaging Type Embossed Tape on Reel  
 Pitch - Mating Interface 0.50mm  
 Pitch - Termination Interface 0.50mm  
 Polarized to PCB No  
 Stackable No  
 Temperature Range - Operating -40°C to +85°C  
 Termination Interface: Style Surface Mount  
 Wire/Cable Type FFC/FPC

**Electrical**

Current - Maximum per Contact 0.5A  
 Voltage - Maximum 50V

**Material Info**

**Reference - Drawing Numbers**

[Packaging Specification](#) SPK-52559-003  
[Product Specification](#) PS-52559-019, RPS--52559-093

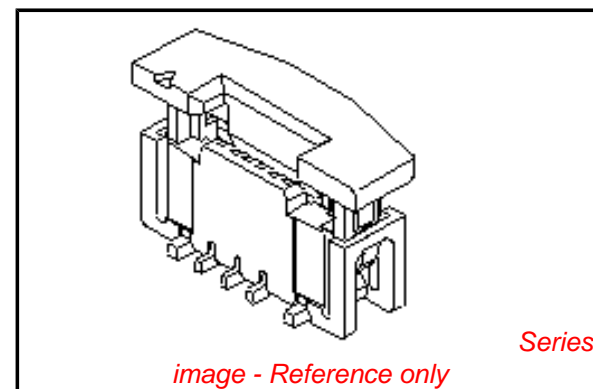

**EU RoHS**

**ELV and RoHS Compliant**  
**REACH SVHC Contains SVHC: No**  
**Low-Halogen Status Not Low-Halogen**

**China RoHS**



**Need more information on product environmental compliance?**

Email [productcompliance@molex.com](mailto:productcompliance@molex.com)  
 For a multiple part number RoHS Certificate of Compliance, [click here](#)

Please visit the [Contact Us](#) section for any non-product compliance questions.

**Search Parts in this Series**

[52559Series](#)

**Mates With**

<a href="http://www.molex.com/product/premoflex\_ffc-fpc.html">Molex Premo-Flex FFC</a>. Be sure to match like plating

This document was generated on 10/08/2014

**PLEASE CHECK [WWW.MOLEX.COM](http://WWW.MOLEX.COM) FOR LATEST PART INFORMATION**