

PLEASE CHECK WWW.MOLEX.COM FOR LATEST PART INFORMATION

Part Number: [52559-2833](#)
Status: **Active**
Overview: FFC-FPC (SMT)
Description: Easy-On™ Type FFC/FPC Connector, Vertical, Surface Mount, ZIF, 28 Circuits, Lead-Free, with Tape Packaging Center Placement Holes

Documents:

[3D Model](#) [Packaging Specification SPK-52559-003 \(PDF\)](#)
[Drawing \(PDF\)](#) [RoHS Certificate of Compliance \(PDF\)](#)
[Product Specification PS-52559-019 \(PDF\)](#)

Agency Certification

UL E29179

General

Product Family FFC/FPC Connectors
 Series [52559](#)
 Overview [FFC-FPC \(SMT\)](#)
 Product Name Easy-On™
 UPC 887191289861

Physical

Circuits (Loaded) 28
 Color - Resin Natural
 Contact Position N/A
 Durability (mating cycles max) 20
 Entry Angle Vertical
 Flammability 94V-0
 Mated Height 3.90mm
 Material - Metal Phosphor Bronze
 Material - Plating Mating Silver, Tin-Bismuth
 Material - Plating Termination Silver, Tin-Bismuth
 Material - Resin Nylon
 Net Weight 352.370/mg
 Number of Rows 1
 Orientation Vertical
 PC Tail Length 2.00mm
 PCB Locator No
 PCB Retention Yes
 Packaging Type Embossed Tape on Reel
 Pitch - Mating Interface 0.50mm
 Pitch - Termination Interface 0.50mm
 Polarized to PCB No
 Stackable No
 Temperature Range - Operating -40°C to +85°C
 Termination Interface: Style Surface Mount
 Wire/Cable Type FFC/FPC

Electrical

Current - Maximum per Contact 0.5A
 Voltage - Maximum 50V

Material Info

Reference - Drawing Numbers

[Packaging Specification](#) SPK-52559-003
[Product Specification](#) PS-52559-019, RPS--52559-093

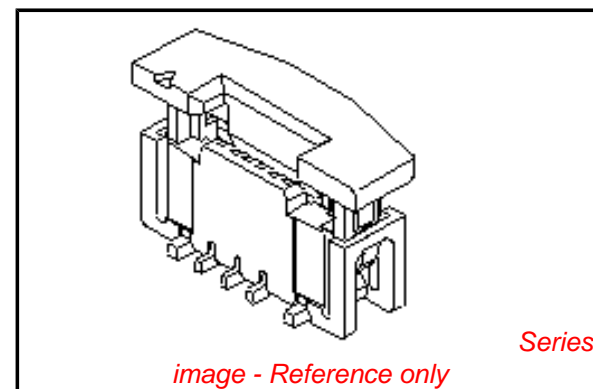

image - Reference only

EU RoHS

ELV and RoHS Compliant
REACH SVHC Contains SVHC: No
Low-Halogen Status Not Low-Halogen

China RoHS



Need more information on product environmental compliance?

Email productcompliance@molex.com
 For a multiple part number RoHS Certificate of Compliance, [click here](#)

Please visit the [Contact Us](#) section for any non-product compliance questions.

Search Parts in this Series

[52559Series](#)

Mates With

http://www.molex.com/product/premoflex_ffc-fpc.html>Molex Premo-Flex FFC. Be sure to match like plating

This document was generated on 10/03/2014

PLEASE CHECK WWW.MOLEX.COM FOR LATEST PART INFORMATION