

PLEASE CHECK WWW.MOLEX.COM FOR LATEST PART INFORMATION

Part Number: **0525591272**
Status: **Contact Molex**
Description: 0.50mm (.020") Pitch FFC/FPC Connector, Vertical, SMT, ZIF, 12 Circuits, Lead-free, with Tape Packaging Center Placement Holes

Documents:

[3D Model](#)
[Drawing \(PDF\)](#)
[Product Specification PS-52559-012 \(PDF\)](#)
[Packaging Specification SPK-52559-003 \(PDF\)](#)
[RoHS Certificate of Compliance \(PDF\)](#)

Agency Certification

UL E29179

General

Product Family FFC/FPC Connectors
 Series 52559
 Product Name N/A

Physical

Circuits (Loaded) 12
 Contact Position N/A
 Durability (mating cycles max) 20
 Entry Angle Vertical
 Flammability 94V-0
 Mated Height 3.90mm (.154")
 Material - Metal Phosphor Bronze
 Material - Plating Mating Tin-Bismuth
 Material - Resin Nylon
 Number of Rows 1
 Orientation Vertical
 PCB Locator No
 PCB Retention Yes
 Packaging Type Embossed Tape on Reel
 Pitch - Mating Interface 0.50mm (.020")
 Polarized to PCB No
 Stackable No
 Temperature Range - Operating -40°C to +85°C
 Termination Interface: Style Surface Mount
 Wire/Cable Type FFC/FPC

Electrical

Current - Maximum per Contact 0.5A
 Voltage - Maximum 50V

Material Info

Reference - Drawing Numbers

Packaging Specification SPK-52559-003
 Product Specification PS-52559-012, RPS-52559-049, RPS-52559-052, RPS-52559-053, RPS-52559-054, RPS-52559-055, RPS-52559-057, RPS-52559-069, RPS-52559-073, RPS-52559-076, RPS-52559-077, RPS-52559-079, RPS-52559-080
 Sales Drawing SD-52559-028, SD-52559-045

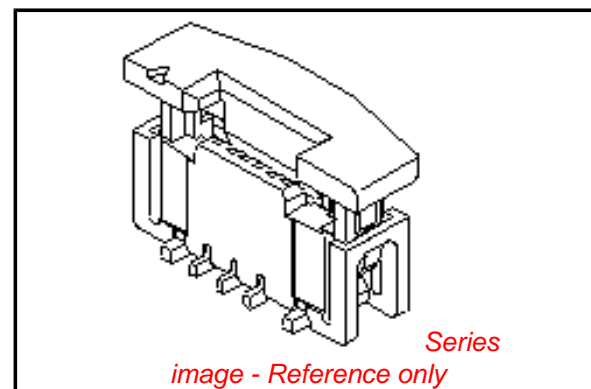

EU RoHS

ELV and RoHS Compliant
REACH SVHC Contains SVHC: No
Low-Halogen Status Not Low-Halogen

China RoHS



Need more information on product environmental compliance?

Email productcompliance@molex.com
 For a multiple part number RoHS Certificate of Compliance, [click here](#)

Please visit the [Contact Us](#) section for any non-product compliance questions.

Search Parts in this Series

[52559Series](#)

This document was generated on 05/18/2011

PLEASE CHECK WWW.MOLEX.COM FOR LATEST PART INFORMATION