

520933-1 ✓ ACTIVE



Positive Lock | Mark II, Positive Lock 187

TE Internal #: 520933-1

Crimp Terminal Housings, Receptacle, Receptacle, 2 Position, Straight, UL 94V-2, Natural, Nylon, Contact Mating Retention, Positive Lock 187

[View on TE.com >](#)

Terminals & Splices > Terminal Housings, Insulation Sleeves & Blocks > Crimp Terminal Housings



Terminal Type: **Receptacle**

Connector & Housing Type: **Receptacle**

Number of Positions: **2**

Terminal Orientation: **Straight**

UL Flammability Rating: **UL 94V-2**

Features

Product Type Features

Sealable	No
Connector System	Wire-to-Board, Wire-to-Wire
Connector & Contact Terminates To	Wire & Cable
Connector & Housing Type	Receptacle

Configuration Features

Number of Positions	2
---------------------	---

Body Features

Primary Product Color	Natural
-----------------------	---------

Contact Features

Terminal Type	Receptacle
Terminal Orientation	Straight
Contact Mating Retention	With

Mechanical Attachment



Mating Alignment Type	Polarization
Mating Alignment	With
Connector Mounting Type	Cable Mount (Free-Hanging)

Housing Features

Housing Material	Nylon
Centerline (Pitch)	14 mm[.551 in]

Dimensions

Product Length	23.19 mm[.913 in]
----------------	-------------------

Usage Conditions

Operating Temperature Range	-40 – 140 °C[-40 – 284 °F]
-----------------------------	----------------------------

Industry Standards

UL Flammability Rating	UL 94V-2
------------------------	----------

Packaging Features

Packaging Quantity	1
Packaging Method	Carton

Product Compliance

[For compliance documentation, visit the product page on TE.com>](#)

EU RoHS Directive 2011/65/EU	Compliant
EU ELV Directive 2000/53/EC	Compliant
China RoHS 2 Directive MIIT Order No 32, 2016	No Restricted Materials Above Threshold
EU REACH Regulation (EC) No. 1907/2006	Current ECHA Candidate List: JUNE 2023 (235) Candidate List Declared Against: JUNE 2023 (235) Does not contain REACH SVHC
Halogen Content	Low Halogen - Br, Cl, F, I < 900 ppm per homogenous material. Also BFR/CFR/PVC Free
Solder Process Capability	Not applicable for solder process capability

Product Compliance Disclaimer

This information is provided based on reasonable inquiry of our suppliers and represents our current actual knowledge based on the information they provided. This information is subject to change. The part numbers that TE has identified as EU RoHS compliant have a maximum concentration of 0.1% by weight in homogenous materials for lead, hexavalent chromium, mercury, PBB, PBDE, DBP, BBP, DEHP, DIBP, and 0.01% for cadmium, or qualify for an exemption to these limits as defined in the Annexes of Directive 2011/65/EU (RoHS2). Finished electrical and electronic equipment products will be CE marked as required by Directive 2011/65/EU. Components may not be CE marked. Additionally, the part

numbers that TE has identified as EU ELV compliant have a maximum concentration of 0.1% by weight in homogenous materials for lead, hexavalent chromium, and mercury, and 0.01% for cadmium, or qualify for an exemption to these limits as defined in the Annexes of Directive 2000/53/EC (ELV). Regarding the REACH Regulation, the information TE provides on SVHC in articles for this part number is based on the latest European Chemicals Agency (ECHA) 'Guidance on requirements for substances in articles' posted at this URL: <https://echa.europa.eu/guidance-documents/guidance-on-reach>

Compatible Parts



TE Part # 170326-1
187 PL MKII REC. 18-14AWG PTBR



TE Part # 170324-1
187 PL MKII REC. 24-20AWG PTBR



TE Part # 170325-1
187 PL MKII REC. 20-16AWG PTBR

Also in the Series | Mark II



Automotive Housings(7)

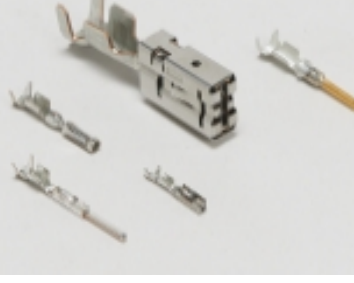

Automotive Terminals(16)



Connector Seals & Cavity Plugs(1)

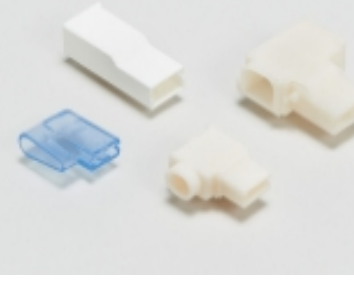

Crimp Terminal Housings(76)



Insertion & Extraction Tools(2)



Other Automotive Connector Accessories(1)



Quick Disconnects(57)

Also in the Series | Positive Lock 187

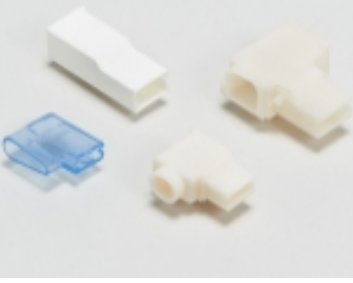

Crimp Terminal Housings(86)



Insertion & Extraction Tools(2)



Insulation Boots & Sleeves(7)



Quick Disconnects(57)

Customers Also Bought

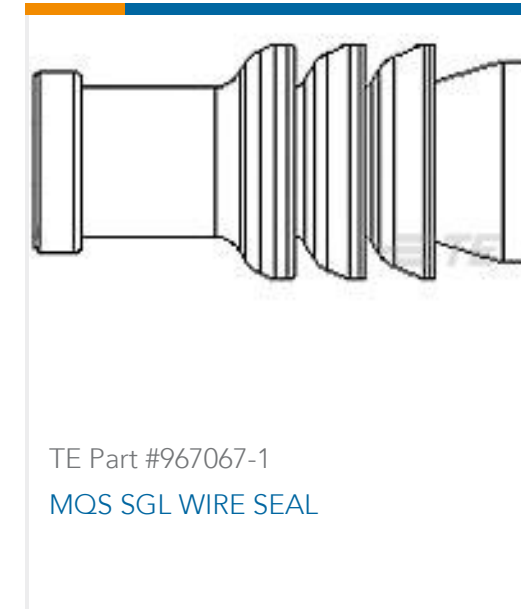

Documents

Product Drawings

POSITIVE LOCK 187 HOUSING NYLON 6/6

English

CAD Files

3D PDF

3D

Customer View Model

[ENG_CVM_CVM_520933-1_D.2d_dxf.zip](#)

English

Customer View Model

[ENG_CVM_CVM_520933-1_D.3d_igs.zip](#)

English

Customer View Model

[ENG_CVM_CVM_520933-1_D.3d_stp.zip](#)

English

By downloading the CAD file I accept and agree to the [Terms and Conditions](#) of use.

Product Specifications

Application Specification

English